

PRO-MED



CHIRURGIE
SURGERY
CHIRURGIE
CIRUGIA
CHIRURGIA

PRO-MED

Dieser Katalog bleibt unser ausschließliches Eigentum.
Unsere "Allgemeinen Lieferungs- und Zahlungsbedingungen" sind in unserer jeweils gültigen Preisliste und im Internet unter www.pro-med-tut.de abgedruckt.
Nachdruck, auch auszugsweise, ist ohne unser schriftliches Einverständnis verboten.

This catalogue remains our exclusive property.
Our "general Terms of Sale and Payment" may be found in our latest valid pricelist as well as on our homepage www.pro-med-tut.de .
Reprinting, even partially, is prohibited without our written consent.

Ce catalogue est exclusivement notre propriété.
Nos "Conditions générales du vente et de paiement" sont mentionnés dans notre liste de prix courante ainsi que sur l'Internet à www.pro-med-tut.de .
Toute représentation ou reproduction intégrale ou partielle - faite sans l'autorisation écrite de la société PRO-MED - est interdite.

Este catálogo es exclusivamente de nuestra propiedad.
Tambien queremos hacer hincapie en nuestras "Condiciones generales de venta y de pago" y a www.pro-med-tut.de .
Reproducción, aunque sea parcial, queda terminantemente prohibida.

Il presente catalogo rimane di nostra proprietà.
Le nostre condizioni di vendita e di pagamento le trovo sul nostro sito www.pro-med-tut.de o sull' attuale listino prezzi.
La riproduzione del catalog e proeibita.

Modelländerungen vorbehalten
Patterns are subject to change
Tous droits réservés des changements de modèle
Salvo modificaciones
Ci riserviamo la facolta di camamenti nei modelli



PRO-MED
INSTRUMENTE GMBH

**Garantierte Qualitätsinstrumente
Guaranteed Quality Instruments
Instruments de Chirurgie de qualité garantie
Instrumentos de Calidad con garantía
Strumenti di chirurgia con qualità garantita**

PRO-MED

Instrumente GmbH
Gänsäcker 9
D-78532 TUTTLINGEN
Germany

Telephone +49(0) 74 62 / 20 42 40
Telefax +49(0) 74 62 / 20 42 49 0
E-Mail pro-med-tut@t-online.de
Internet www.pro-med-tut.de

PRO-MED

Qualität ist eine Frage des Anspruchs ...

Quality is a question of demand ...

La qualité est une question d'exigence ...

Calidad es la pregunta de pretension ...

Qualità è una domanda di pretesa...



1

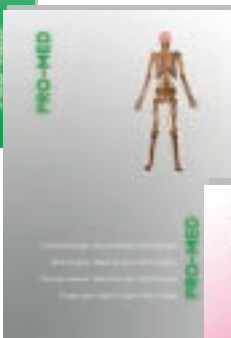

2

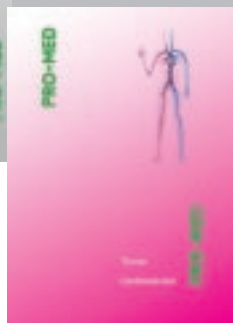

3

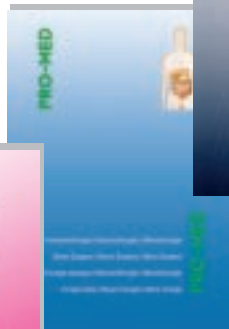

4



5



6



7



8

Catalogs

- 1 Surgery
- 2 Bone Surgery / Neuro Surgery / Micro Surgery
- 3 Thorax / Cardiovascular
- 4 Stomach / Intestines / Rectum / Liver / Gall
Kidneys / Urology / Gynecology / Obstetrics

- 5 ENT
- 6 Aneurysm Clips
- 7 Click-Kerrison
- 8 Sterilisation

ÜBERSICHTSTAFEL
SECTION INDEX
SOMMAIRE
CONTENU
INDICE DI CATALOGO

SEITE
PAGE
PAGE
PAGINA
PAGINA

ALPHABETISCHES INHALTSVERZEICHNIS ALPHABETICAL INDEX INDEX ALPHABÉTIQUE INDICE ALFABÉTICO INDICE ALFABETICO		1.1 - 1.13 2.1 - 2.13 3.1 - 3.13 4.1 - 4.13 5.1 - 5.13
NUMMERNVERZEICHNIS NUMERICAL INDEX INDEX NUMÉRIQUE INDICE NUMÉRICO INDICE NUMERICO		6.1 - 6.15
DIAGNOSTIK DIAGNOSTICS DIAGNOSTIC DIAGNÓSTICO DIAGNOSTICA		7 - 20
VERGLEICHSTRUMENTE COMPARING INSTRUMENTS INSTRUMENTS A COMPARISON INSTRUMENTOS PARA COMPARACION STRUMENTI DI PARAGONE		21 - 25
VORBEREITUNG, DERMATOLOGIE PREPARATION, DERMATOLOGY PRÉPARATION, DERMATOLOGIE PREPARACIÓN, DERMATOLOGIA PREPARAZIONE, DERMATOLOGIA		27 - 34
NARKOSE ANAESTHESIA ANESTHÉSIE ANESTESIA ANESTESIA		35 - 46
SKALPELLE, MESSER SCALPELS, KNIVES BISTOURIS, COUTEAUX BISTURÍES, CUCHILLOS BISTURI, COLTELLI		47 - 64
SCHEREN SCISSORS CISEAUX TIJERAS FORBICI		65 - 138
PINZETTEN FORCEPS PINCES PINZAS PINZE		139 - 207
ARTERIENKLEMMEN, PRÄPARIERKLEMMEN HEMOSTATIC FORCEPS, DISSECTING FORCEPS PINCES HÉMOSTATIQUES, PINCES À PRÉPARATION PINZAS HEMOSTÁTICAS, PINZAS PARA PREPARACIONES PINZE EMOSTATICHE, PINZE PER PREPARAZIONE		209 - 287
TUCHKLEMMEN, SCHLAUCHKLEMMEN, TUPFERZANGEN TOWEL CLAMPS, TUBING CLAMPS, DRESSING- AND SPONGE FORCEPS PINCES À CHAMPS, PRESSE-TUBES, ET TAMPONS PINZAS DE CAMPO, PARA TUBOS Y PARA TAMPONES PINZE FISSATELLI, PINZE SERRATUBI, PINZE PER TAMPONI		289 - 299

**BERSICHTSTAFEL
SECTION INDEX
SOMMAIRE
CONTENU
INDICE DI CATALOGO**

**SEITE
PAGE
PAGE
PÁGINA
PAGINA**

WUNDHAKEN
RETRACTORS
ECARTEURS
SEPARADORES
DIVARICATORI



301 - 384

WUNDSPREIZER, BAUCHDECKENHALTER
RETRACTORS, SELF-RETAINING, ABDOMINAL RETRACTORS
ECARTEURS AUTOSTATIQUES, ECARTEURS ABDOMINAUX
SEPARADORES AUTOSTÁTICOS, SEPARADORES ABDOMINALES
DIVARICATORI AUTOSTATICI, DIVARICATORI ADDOMINALI



387 - 466

NAHT
SUTURE
SUTURE
SUTURA
SUTURA



469 - 517

SONDEN, ASPIRATION, PUNKTION, VARIZEN, INJEKTION
PROBES, ASPIRATION, PUNCTURE, VARIX, INJECTION
STYLETS, ASPIRATION, PUNCTURE, VARICES, INJECTION
ESTILETES, ASPIRACIÓN, PUNCIÓN, VARICES, INYECCIÓN
SPECILLI, ASPIRAZIONE, PUNTURA, VARICI, INIEZIONE



519 - 552

VERBAND, GIPS
BANDAGE, PLASTER
PANSEMENTS, PLÂTRE
VENDAJES, YESO
BENDAGGIE, GESSATURE



555 - 560

BARIATRISCHE CHURURGIE
BARIATRIC SURGERY
CHIRURGIE BARIATRIQUE
CIRUGIA BARIATRICA
CHIRURGIA BARIATRICA



563 - 580

AUTOPSIE
POST MORTEM
AUTOPSIE
AUTOPSIA
AUTOPSIE



583 - 588

STERILISATION, VERSCHIEDENES
STERILIZATION, MISCELLANEOUS
STÉRILISATION, ARTICLES DIVERS
ESTERILIZACIÓN, DIVERSON ARTICULOS
STERILIZZAZIONE, ARTICOLI DIVERSI

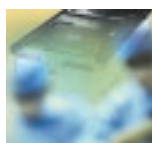

591-612



DIAGNOSTIK
DIAGNOSTICS
DIAGNOSTIC
DIAGNÓSTICO
DIAGNOSTICA

Blutdruckmesser
Blood Pressure Manometers
Tensiomètres
Sfigmanómetros
Sfigmanometri



10.0010 NOVA-PRESAMETER

Quecksilbergerät in Metalletui. Skala bis 300 mm Hg.
Fehlertoleranz: +/- 3 mm Hg. Kalibrierte Velcromanschette mit
Latexpolster 2-Schlauch.

Mercurial sphygmomanometer in metal case. Graduated scale;
maximum reading 300 mm Hg. Maximum error throughout range
+/- 3 mm Hg. Calibrated nylon velcro cuff with 2-tube latex
bladder.

Appareil à colonne de mercure en boîtier métallique. Echelle
anodisée jusqu'à 300 mm Hg. Tolérance maximale +/- 3 mm Hg.
Avec brassard nylon-velcro, calibré, et vessie latex à 2 tubes.

Tensiómetro de mercurio en estuche metálico. Escala anodizada
hasta 300 mm Hg. Tolerancia max +/- 3 mm Hg. Brazaletes velcro
de nilon, calibrado, con bolsa latex de 2 tubos

Sfigmanometro in astuccio metallo, Scala 0 - 300 mmHg.
Tolleranza +/- 3 mmHg. Bracciale calibrato velcro-nylon di camera
d'aria di latex a 2-tubi.



10.0020 PRECISA N

Manometer-Blutdruckmessgerät; ergonomischer
Löffelgriff; Lineare Skale 0 - 300 mm Hg; maximale
Fehlertoleranz +/- 3 mmHg

Blood Pressure Manometer; Ergonomic spoon-shaped
grip; linear, tilted aluminum scale from 0 to 300 mm Hg;
max. error tolerance +/- 3 mmHg

Tensiomètre à cadran; poignée-cuiller ergonomique;
graduation linéaire inclinée, de 0 à 300 mm Hg;
tolérance max. d'erreur +/- 3 mmHg

Tensiómetro aneroides; Mango de cuchara ergonómico;
Escala de aluminio lineal, inclinada, 0 - 300 mmHg;
Máxima tolerancia de error de +/- 3 mmHg

Sfigmanometro moderno e economico. Scala 0 - 300
mmHg, 53 mm Ø. Valore massimo 300 mmHg.
Tolleranza +/- 3 mmHg. Bracciale calibrato velcro-nylon
di camera d'aria di latex a 1 tubo

Blutdruckmesser
Blood Pressure Manometers
Tensiomètres
Sfigmanometros
Sfigmanometri



10.0030 MINIMUS II

Einhandmodell in Vinyltasche mit Reißverschluss. Keine Nullpunktfixierung. Gut ablesbare Aluminiumskala Ø 49 mm bis 300 mm Hg. Maximale Fehlertoleranz +/- 3 mm Hg. Mit kalibrierter Nylon-Velcromanschette komplett mit Latexpolster 1-Schlauch.

Palm-style sphygmomanometer in vinyl zipper case. Graduated aluminum scale Ø 49 mm. Maximum reading 300 mm Hg. Maximum error +/- 3 mm Hg. With calibrated nylon-velcro cuff and 1-tube latex bladder.

Manopoire en étui vinyl avec fermeture éclair. Echelle Ø 49 mm jusqu'à 300 mm Hg. Tolérance maximale +/- 3 mm Hg. Avec brassard nylon-velcro calibré, et vessie latex à 1 tube.

Modelo de mano. Lectura de la escala Ø 49 mm hasta 300 mm Hg. Tolerancia max. +/- 3 mm Hg. Brazaletes velcro de nilón, calibrado; cámara d'aria de latex ad 1 tubo.

Sfigmanometro ad aneroide in borsa vinilpelle con cerniera lampo. Senza fissaggio a zero. Scala graduata in alluminio 49 mm Ø, 0 - 300 mmHg. Tolleranza +/- 3 mmHg. Bracciale calibrato velcro-nylon di camera d'aria di latex a 1 tubo



10.0040 EXACTA

Hochleistungs-Blutdruckmessgerät in 2-Schlauch-Ausführung. Lineare Skala Ø 40 mm, von 0 - 300 mm Hg; max. Fehlertoleranz +/- 3 mmHg

High quality Sphygmomanometer in a 2-tube version; Linear scale Ø 49 mm, 0 - 300 mmHg; Max. error tolerance +/- 3 mmHg

Tensiomètre à cadran de haute qualité à 2 tubes; Graduation linéaire, Ø 49 mm de 0 à 300 mmHg; tolérance max. d'erreur de +/- 3 mmHg

Tensiómetro de precisión de alta calidad, con 2 tubos; Escala lineal Ø 49 mm, 0 - 300 mmHg; Máxima tolerancia de error de +/- 3 mmHg

Sfigmanometro di alta prestazione. Scasla lineare 0 - 300 mmHg, 49 mm Ø. Tolleranza +/- 3 mmHg. Bracciale calibrato velcro-nylon di camera d'aria di latex a 2 tubi



kalibrierte Nylon-Velcromanschetten, 2-Schlauch

Calibrated nylon-velcro cuffs 2-tube

Brassards nylon-velcro calibré avec 2-tubes

Brazeletes velcro de nilón con 2 tubos

Bracciali velcro solo a 2 tubi

10.0080

für Erwachsene / for adults / pour adultes / para adultos / per adulti

10.0081

für Erwachsene (dünne Arme) / for adults (thin arms) / pour adultes (bras minces) / para adultos (brazos delgados) per adulti (braccia fine)

10.0082

für Oberschenkel /for femur / pour fémur / para muslo / per coscie

10.0083

für Neugeborene / for newborn / p. nouveaux-nés / p. racien nacidas / per neonato

10.0084

für Säuglinge / for Infants / pour bébés / p. lactantes / per lattante

10.0085

für Kinder / for children / pour enfants / para niños / per bambini

kalibrierte Nylon-Velcromanschetten, 1-Schlauch

Calibrated nylon-velcro cuffs 1-tube

Brassards nylon-velcro calibré avec 1-tube

Brazeletes velcro de nilón con 1 tubo

Bracciali velcro solo a 1 tubo

10.0090

für Erwachsene / for adults / pour adultes / para adultos / per adulti

10.0091

für Erwachsene (dünne Arme) / for adults (thin arms) / pour adultes (bras minces) / para adultos (brazos delgados) per adulti (braccia fine)

10.0092

für Oberschenkel /for femur / pour fémur / para muslo / per coscie

10.0094

für Neugeborene / for newborn / p. nouveaux-nés / p. racien nacidas / per neonato

10.0095

für Kinder / for children / pour enfants / para niños / per bambini

Instrumente für HNO
Instruments for ENT
Instruments pour ORL
Instrumentos para ORL
Strumenti per ORL



10.0102 HNO / ENT / ORL DELUXE

Modernes HNO Qualitätsbesteck mit Fiber-Optik und Halogenbeleuchtung 2,5/3,5V bestehend aus:

Batteriegriff (ohne Batterien)

Otoskop: abnehmbare Linse vergrößert 2,5-fach, Schwenklinse vergrößert 4-fach, Spekulumauswerfer, 4 wiederverwendbare Ohrtrichter 2, 3, 4, 5 mm und je 5 Einwegohrtrichter 2,5 und 4 mm

Ophthalmoskop: Korrekturlinsen -35 +40 Dioptrien. Blenden: Kreis groß und klein; Halbkreis, Fixierstern, Schlitz und Karo. Filter: Grün-, Blau- und Polarisationsfilter. Fokussiereinstellung.

Nasenspekulum. Spatelhalter, Kehlkopfspiegel: Nr. 3 + 4. Lampenträger

ENT DE LUXE Oto-Ophthalmoscope Set with fibre optics and halogen illumination 2,5/3,5 V consisting of:

Battery handle (without batteries)

Otoscope: Removable 4x magnifying lens; ejector for specula, plastic tube with 4 reusable ear specula 2,3,4, and 5 mm; and 5 ea. disposable ear specula 2,5 and 4 mm.

Ophthalmoscope: Corrective lenses: -35 to +40 diopters. Apertures: large + small circle, semi-circle, fixation star slit + grid. Filter: green, blue, and polarizing filter. Each filter can be switched to each aperture. Unique focusing device.

Nasal Speculum. Tongue blade holder. Throat mirrors No 3 and 4. Bent arm illuminator.

Trousse à ORL et Oto-Ophthalmoscopie DE LUXE à fibre optique et éclairage halogène 2,5 / 3,5 V. comprenant de:

Manche à piles (sans piles)

Otoscope: Loupe peut être enlevée et grossit 2,5 fois. Loupe pivotante grossit 4 fois. Ejecteur pour spéculums auriculaires. Tube en plastique avec 4 spéculums auric. réutilisables 2, 3, 4 et 5 mm. 5 spéculums auric. à usage unique 2,5 et 4 mm.

Ophthalmoscope: Lentilles de correction -35 à +40 D. Diaphragmes: grand cercle, petit cercle, demi-cercle, étoile p. fixation, fente et damier. Filtres: vert, bleu, et filtre de polarisation. On peut ajouter chaque filtre à chaque lentille.

Spéculum nasal. Porte-abaisse-langue. Mirroirs laryngien: No. 3 + 4. Porte-lampe.

Juego DELUXE para oto-oftalmología con fibra óptica e iluminación halógena, compuesto de:

Mango de pilas (sin pilas)

Otoscopio: Lente desmontable aumenta 2,5 veces más. Lente giratoria aumenta 4 veces más. Expulsor para espéculos. Tubito de plástico con 4 espéculos reutilizables 2,3,4 y 5 mm. 5 espéculos desechables 2,5 y 4 mm.

Oftalmoscopio: Lentes de corrección: -35 hasta +40 D. Aperturas: círculo grande y pequeño, semicírculo, estrella fijadora, rendija y cuadrículado. Filtros: verde, azul y polarizador. Se pueden utilizar cada filtro con cada apertura.

Espéculo nasal. Porta-abaja-lengua. Espejos laringeos No's 3 + 4. Porta lámpara.

Ferri DE LUXE di alta qualità per otorinolaringoiatria con illuminazione alogena e a fibre ottiche 2,5/3,5V.

Manico a pila (senze pile)

Otoscopio: Lente d'ingrandimento astraibile 4x. Dispositivo per espulsione specoli auricolari.

Oftalmoscopio: lenti correttive de -35 a +40 diottrie. Aperture: a cerchio grande e piccolo, semicerchio, a stella, a fessura, a reticolo. Filtri: verde, blu e filtro di polarizzazione. Controllo della messa a fuoco.

Speculo nasale. Porta abbassalingua. Specchietti per laringe no. 3 e 4. Portalampadina a squadra.



10.0105 HNO / ENT / ORL ECONOM 2,7 V

Komplett-Diagnostik-Besteck bestehend aus:

Otoskop: mit Steckverschluß, abnehmbares Abdeckglas, Konnektor für pneumatischen Test, verchromte Schwenklinse abnehmbar mit 4-fach Vergrößerung, wiederverwendbare Ohrtrichter 2, 3 und 4 mm Ø

May-Ophthalmoskop: mit Steckverschluß, Korrekturlinsen von 0 bis +20 und 0 bis -20 Dioptrien; Blende: großer Kreis

Nasenspekulum spreizbar

Lampenträger: 2 Kehlkopfspiegel Nr. 3 und 4,

Mundspatelhalter, Ersatzlampe, Otoskop 2,5 V.

Complete Diagnostic Set consisting of:

Otoscope head with plug-in connector; removable cover glass; Connector for pneumatic test; swivel lens removable, with 4x magnification; Reusable ear-specula with 2, 3, & 4 mm Ø

May Ophthalmoscope head with plug-in connector; Correction lenses from 0 to +20 and 0 to -20 dioptres; Aperture: large circle.

Nasal Speculum expandable; **Bent arm illuminator:** 2 laryngeal mirrors No 3 & 4; **Tongue blade holder;**

Replacement lamp otoscope, 2,5 V

Trousse diagnostique complet comprenant de:

Tête d'otoscope avec fermeture à emboîtement; Verre amovible de protection; Raccord pour le test pneumatique;

Lentille pivotante amovible, grossissement au facteur 4; Etonnoirs auriculaires réutilisables de 2, 3, et 4 mm de Ø

Tête d'ophthalmoscope May avec fermeture à emboîtement; Lentilles de correction de 0 à +20 et de 0 à -20 dioptries;

Diaphragme: grand cercle.

Speculum nasal à écartement; Support de lampe: deux laryngoscopes No. 3 et No. 4; Support pour

abaisse-langue; Lampe de rechange pour otoscope 2,7 V.

Juego completo de diagnóstico, compuesto de:

Cabecal de otoscopio con cierre encajable; tapa de vidrio desmontable; Conector para prueba neumática; Lente basculante, desmontable, con aumento 4x; Espéculos auriculares reutilizables de 2, 3 y 4 mm de Ø

Cabecal de oftalmoscopio May: con cierre encajable; Lentes correctoras de 0 a +20 y de 0 a -20 dioptrías; Diafragma: círculo grande

Espécula nasal expansible; Portalámparas: 2 espejos laríngeos; Nos. 3 y 4; Soporta para pala; Lámpara de recambio para otoscopio 2,7 V.

Set per diagnostica.

Testa otoscopio: chiusura a vite. Connettore di plastica per test pneumatico. Lente d'ingrattamento 4x in montatura girevole estraibile. Specoli da 2, 3 e 4 mm riusabili.

Oftalmoscopio di May: chiusura a vite. Lentes di correzione da 0 a +20 e da 0 a -20 diottrie. Apertura singola a cerchio grande.

Specolo nasale; Due specchietti laringei, Misura 3 e 4. Lampadina di ricambio 2,7 V.



10.0106 OTOSKOP UNI I

Standardbeleuchtung 2,7 V. mit Batteriegriff für pneumatischen Test. Vergrößerung 4-fach, mit 3 wiederverwendbaren Ohrtrichtern 2, 3 und 4 mm

Standard illumination 2,7 V. Battery handle for pneumatic test. 4x magnification; with 3 reusable ear specula 2, 3, and 4 mm.

Eclairage standard 2,7 V. Manche à piles, pour le test pneumatique; grossissement 4x; avec 3 spéculums auriculaires de 2, 3 et 4 mm

Iluminación standard 2,7 V. Mango de pilas, para el test neumático; amplificación 4 veces; 3 espejos reutilizables 2, 3 y 4 mm.

Iluminazione standard 2,7 V; manico a pila, per il test pneumatico; ingrandimento 4 x; con 3 specoli riusabili da 2, 3 e 4 mm

10.0108 OTO-OPHTHALMOSKOP UNI III

Standartbeleuchtung 2,7 V; mit Batteriegriff; technische Daten wie 10.0105 und 10.0106

Standard illumination 2,7 V. Battery handle; technical data as 10.0105 and 10.0106

Eclairage standard 2,7 V. Manche à piles; caractéristiques techniques come 10.0105 et 10.0106

Iluminación standard 2,7 V. Mango de pilas; datos técnicos como 10.0105 y 10.0106

Iluminazione standard 2,7 V; manico a pila; dati tecnici come 10.0105 e 10.0106



10.0107 OPHTHALMOSKOP UNI II

May-Ophthalmoskop Standartbeleuchtung 2,7 V; mit Batteriegriff; Korrekturlinsenwahl von 0 bis +20 und 0 bis -20 Dioptrien und Lichtstärkeregelung

May ophthalmoscope. Standard illumination 2,7 V. Battery handle; choice of corrective lenses from 0 to +20 and 0 to -20 dioptries; Rheostat for light control

Ophthalmoscope May. Eclairage standard 2,7 V. Manche à piles; lentilles de correction de 0 à +20 et de 0 à -20 D. Illumination réglable par degrés

Oftalmoscopio May. Iluminación standard 2,7 V. Mango de pilas; lentes de corrección de 0 a +20 y 0 a -20 dioptrias; intensidad de luz regulable por reostato.

Oftalmoscopio di May. Illuminazione standard 2,7 V; manico a pila; scelta di lenti di correzione da 0 a +20 e da 0 a -20 diottrie.





10.0110 OTOSKOP S

Otoskop mit Glasfaseroptik und Halogenbeleuchtung 2,5/3,5 V bestehend aus:

1 Batteriegriff C (ohne Batterien) mit Bajonettverschluß; abnehmbare Linse 2,5-fach vergrößernd, Schwenklinse für Operationen vergrößert 4-fach; 1 Otoskop-Aufsatz mit Operationslupe; 4 wiederverwendbare Ohrtrichter 2, 3, 4 und 5 mm Ø; je 5 Einwegohrtrichter 2,5 und 4 mm Ø; Metallkonnektor für pneumatischen Test.

Otoscope with fiber optic and halogen illumination 2,5/3,5V consisting of:

Battery handle type C (without batteries); Otoscope head with bayonet fitting. Removable lens magnifies 2,5x; 4x swivel-magnifier; Connector for pneumatic otoscopy; 4 reusable ear specula 2, 3, 4 + 5 mm Ø. 5 ea. disposable ear specula 2,5 and 4 mm Ø

Otoscope à fibres de verre et éclairage halogène 2,5/2,5V comprenant de:

Manche-C (sans piles). Tête d'otoscope à fermeture baionette. La loupe peut 1 être enlevée et grossit 2,5 fois. Loupe pivotante pour opérations grossit 4 fois; Connexion pour test pneumatique; 4 spéculums réutilisables de 2, 3, 4 et 5 mm Ø, 5 spéculums à usage unique de 2,5 et 4 mm Ø.

Otoscopio con fibra óptica e iluminación halógena 2,5V/3,5V compuesto de: 1 Mango de pilas con cierre de bayoneta (sin pilas); lupa desmontable aumenta 2,5 veces. Lente giratoria para operaciones aumenta 4 veces; conexión para test neumático; 4 espéculos reutilizables de 2, 3, 4 y 5 mm Ø, y 5 espéculos desechables de 2,5 y 4 mm Ø; conector metálico para test neumático.

Otoscopio. Illuminazione a fibre ottiche e alogena 2,5V/3,5V. Manico a pila. Attacco a baionetta. Lente d'ingrandimento estraibile 2,5X, ingrandimento per operazioni 4X; Conettore per test pneumatico. 4 specoli auricolari 2, 3, 4 e 5 mm; 5 specoli monouso cad 2,5 e 4 mm

10.0120 OTO / OPHTHALMOSKOP S

mit Halogenbeleuchtung 2,5 / 3,5 V, Batteriegriff C, technische Daten wie 10.0110 und 10.0115

with halogen illumination 2,5 / 3,5 V, battery handle type C, technical data as 10.0110 und 10.0115

avec éclairage halogène 2,5 / 3,5 V. Manche à piles type C, caractéristiques techniques comme 10.0110 et 10.0115.

con iluminación halógena 2,5 / 3,5 V. Mango de pilas "C". Datos técnicos como 10.0110 y 10.0115.

con illuminazione alogena 2,5 / 3,5 V. Manico a pila "C" (senza pila), dati tecnici come 10.0110 e 10.0115.



10.0111 OPHTHALMOSKOP S 2,5 V

Ophthalmoskop mit Halogenbeleuchtung 2,5/3,5V bestehend aus: Batteriegriff mit Bajonettverschluß und Rheostat (ohne Batterien); Verifokal-Ophthalmoskopkopf; separate Lupe mit 5-facher Vergrößerung.

Ophthalmoscope with halogen illumination, 2,5/3,5V consisting of: battery handle with bayonet fitting and rheostat (without batteries); Verifocal Ophthalmoscope head; separate 5x magnification loupe.

Ophthalmoscope avec éclairage halogène 2,5/2,5V comprenant de: Manche porte-piles à fermeture baionette et rheostat (sans piles); tête d'ophthalmoscope verifocal; loupe agrandissement 5x.

Oftalmoscopio con fibra óptica e iluminación halógena 2,5/3,5V compuesta de: Mango de pilas con cierre de bayoneta reóstato (sin pilas); Cabeza del oftalmoscopio verifocal; Lupa extra con aumento 5x.

Oftalmoscopio. Illuminazione a fibre ottiche e alogena 2,5V/3,5V. Manico a pila. Attacco a baionetta. Lenti correttive da -35 a +40 diottrie. Aperture: a cerchio grande e piccolo, a semicerchio, a stella, a fessura, a reticolo; con lente aggiuntiva ad ingrandimento 5X.





10.0135 OTOSKOP MINI

Kleines, sehr modernes Taschenbesteck mit Halogen-Beleuchtung 2,5 V bestehend aus:

Batteriegriff für 2 Batterien Typ AA (ohne Batterien). **Otoskop** Fiber-Optik, mit Metallkonnektor für pneumatischen Test; je 5 wiederverwendbare Ohrtrichter 2,5 und 4 mm Ø;

Small, very modern pocket-set with halogen-illumination 2,5 V consisting of: **Battery handle** for 2 batteries type AA (without batteries); **Otoscope** fibre optic, screw-type fitting; 5 ea. reusable ear specula 2,5 and 4 mm Ø.

Trousse très moderne et de très bonne qualité pour le coffret du médecin avec optique à fibres de verre 2,5 V comprenant de:

Manche à piles pour 2 piles type AA (sans piles); **Otoscope** fibre optique; avec connecteur en métal pour le test pneumatique; 5 spéculums auriculaires de chaque taille 2,5 et 4 mm Ø.

Juego muy moderno y pequeño para el bostillo del médico con fibra óptica 2,5 V compuesto de: **Mango** para 2 pilas Tipo AA (sin pilas); **Otoscopio**: fibra óptica; con conector metálico para test neumático; 5 espéculos reutilizables de 2,5 y 4 mm Ø.

Strumento piccolo, moderno con **manico** per 2 batterie tipo AA, per il test pneumatico. **Otoscopio** con illuminazione alogena 2,5 V. Lente d'ingrandimento 2,5X. Con 5 specoli auricolari riusabili 2,5 e 4,0 mm cad. Oftalmoscopio con illuminazione alogena; lenti correttive da 0 a +20 e da 0 a -20 diottrie.



10.0136 OPHTHALMOSKOP MINI

Kleines, sehr modernes Taschenbesteck mit Halogen-Beleuchtung 2,5 V bestehend aus:

Batteriegriff für 2 Batterien Typ AA (ohne Batterien). **Ophthalmoskop**: Korrekturlinsen 0 bis +20 und 0 bis -20 Dioptrien. Blenden: Kreis groß und klein, Halbkreis, Fixierstern und Grünfilter.

Small, very modern pocket-set with halogen-illumination 2,5 V consisting of:

Battery handle for 2 batteries type AA (without batteries); **Ophthalmoscope**: Corrective lenses 0 to +20 and 0 to -20 diopters. Apertures: large and small circle, fixation star and green filter.

Trousse très moderne et de très bonne qualité pour le coffret du médecin avec optique à fibres de verre 2,5 V comprenant de:

Manche à piles pour 2 piles type AA (sans piles); **Ophthalmoscope**: Lentilles de correction 0 à +20 et 0 à -20 diaphragmes; cercle grand et petit; demi-cercle; étoile pour fixation et filtre vert.

Juego muy moderno y pequeño para el bostillo del médico con fibra óptica 2,5 V compuesto de: **Mango** para 2 pilas Tipo AA (sin pilas);

Oftalmoscopio: Lentilles de correction 0 hasta +20 y 0 hasta -20 dioptrias. Aperturas: círculo grande y pequeño, semicírculo, estrella fijadora y filtro verde.

Strumento piccolo, moderno con **manico** per 2 batterie tipo AA. **Oftalmoscopio**: Lenti correttive da 0 a +20 e da 0 a -20 diottrie. Aperture: a cerchio grande e piccolo, semicerchio, a stella, filtro verde.



10.0137 OTO/OPHTHALMOSKOP MINI TASCHENBESTECK

Beschreibung wie Artikel 10.0135 und 10.0136. Otoskop und Ophthalmoskop mit je einem Batteriegriff für 2 Batterien Typ AA

Description as Items 10.0135 and 10.0136; Otoscope and Ophthalmoscope are supplied with one ea. Battery handle for 2 batteries type AA.

composé comme articles 10.0135 et 10.0136; Otoscope et ophthalmoscope sont livrées avec manches pour piles type AA

compuesto como artículos 10.0135 y 10.0136. Otoscopio y Oftalmoscopio con mangos para pilas tipo AA.

con manico per 2 batterie Tipo AA. Dati tecnici come 10.0135 e 10.0136

Perkussionshämmer
Percussion Mallets
Marteaux à percussion
Martillos de percusión
Martelli percussori

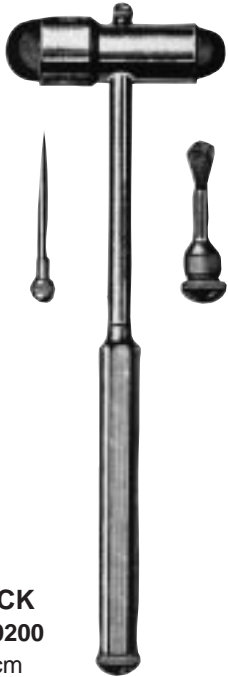

BUCK
10.0200
18 cm



DEJERINE
10.0220
20 cm



DEJERINE
10.0221
20 cm



TAYLOR
10.0250
19 cm



BABINSKY
10.0260
24 cm



BERLINER
10.0270
17 cm
10.0272
20 cm



TROEMNER
10.0280
25 cm

Sensibilitätsinstrumente, Dynamometer
Sensibility Instruments, Dynamometer
Algesimètres, Dynamomètres
Algesímetros, Dinamómetro
Algesimetri, Dinamometro



WARTENBERG
10.0100
18 cm



ALY
10.0330
18 cm



COLLIN
10.0300
Erwachsene
Adult
Adulte
Adultos

Stethoskope
Stethoscopes
Stéthoscopes
Estetoscopios
Stetoscopi



aus Aluminium
of aluminium
de aluminium
de aluminio
in alluminio

PINARD
10.0400
15 cm

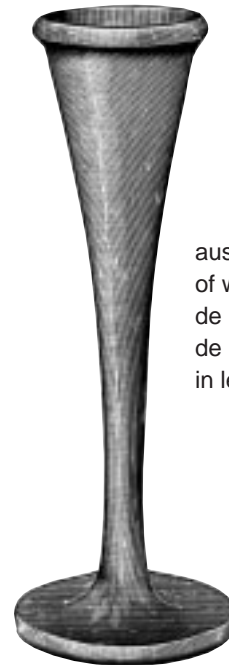

aus Holz
of wood
de bois
de madera
in legno

PINARD
10.0410
18 cm



DUPLEX
10.0460



DUPLEX DE LUXE
10.0462

<p>OCULUS Binokulare Kopflupe OCULUS Binocular Magnifying Loupe OCULUS Loupe binoculaire frontale OCULUS Lupa frontal binocular OCULUS Lente binoccolare frontale</p>	<p>Vergrößerung magnification grossissement aumento Ingrandimento</p>	<p>Arbeitsabstand working distance distance de travail distancia de trabajo distanza di osservazione</p>	<p>Arbeitsfeld working field champ visuel campo de visión campo visivo</p>
<div data-bbox="193 488 858 815" data-label="Image"> </div> <p>28.7050 OCULUS Lupenbrille mit Gestell / binocular loupe with frame loupe binoculaire avec monture / lupa binocular con montura/ Occhiali a lenti binoculari</p>	<p>1,8X</p>	<p>370 mm</p>	<p>90 mm</p>
<div data-bbox="277 987 740 1227" data-label="Image"> </div> <p>28.7055 OCULUS Lupe allein / magnifying loupe only loupe seule / lente de aumento suelte / Lente sola</p>	<p>1,8X</p>	<p>370 mm</p>	<p>90 mm</p>
<p>28.7057 OCULUS Vorsatzobjektive 2,0X zur Montage an 1,8X slip-on objectives to increase 1,8X to 2,0X loupes additionnelles de 1,8X à 2,0X lentes adicionales de 1,8X a 2,0X 2 lenti addizionali, ingrandimento 2,0 x</p> <div data-bbox="692 1442 884 1675" data-label="Image"> </div>	<p>2,0X</p>	<p>220 mm</p>	<p>50 mm</p>
<p>28.7058 OCULUS Vorsatzobjektive 2,5X zur Montage an 1,8X slip-on objectives to increase 1,8X to 2,5X loupes additionnelles de 1,8X à 2,5X lentes adicionales de 1,8X a 2,5X 2 lenti addizionali, ingrandimento 2,5 x</p> <div data-bbox="692 1733 884 1966" data-label="Image"> </div>	<p>2,5X</p>	<p>180 mm</p>	<p>45 mm</p>
<p>28.7059 OCULUS Etui alleine / case only / etui seule / estuche suelto / Astucchio solo</p>			

Stirnspiegel und -lampen
Head Mirrors and Lights
Mirroirs frontaux
Espejos frontales
Specchi frontali



ZIEGLER
10.0700
compl.



ZIEGLER
10.0709



10.0707



CLAR
10.0730
55 mm
6 V.



CLAR
10.0731
100 mm
6 V.

Klein-Transformator 220 Volt, stufenlos regulierbar von 0-10 Volt
Mini-Transformer 220 Volts, infinitely variable from 0-10 Volts
Transformateur, petit modèle, de 220 Volts, réglable sans paliers de 0 à 10 Volts
Transformador pequeño 220 voltios, con regulación continua de 0 a 10 voltios
Trasformatore piccolo, 220 Volt, regolazione continua da 0 a 10 Volt



CLAR
10.0737



CLAR
10.0739 6 V.



10.0750

VERGLEICHSTRUMENTE
COMPARING INSTRUMENTS
INSTRUMENTS A COMPARISON
INSTRUMENTOS PARA COMPARACION
STRUMENTI DI PARAGONE

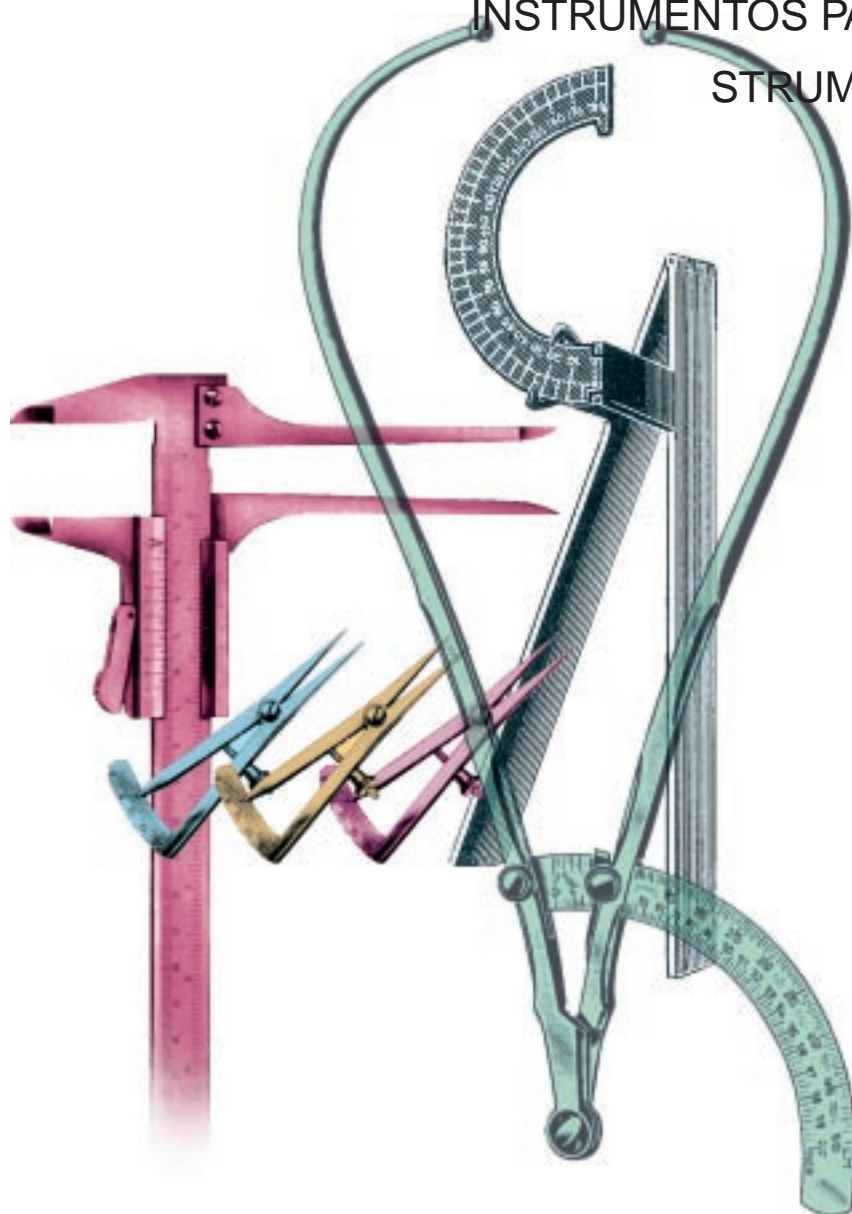



COLLIN
 10.0300

Dynamometer / Dynamometer /
 Dynamomètre / Dinamómetro /
 Dinamometro



MOELTGEN
 10.0310

Winkelmasser / Goniometers /
 Goniomètres / Goniómetros / Goniometri



CAROLL
 10.0315 14 cm



WEBER
 10.0325

Aesthesiometer
 Aesthesiometer
 Estésiometre
 Estesiómetro
 Estesiometro



10.0331 10 cm / 4" **10.0322** 15 cm / 6" **10.0333** 20 cm / 8" **10.0334** 30 cm / 12" **10.0335** 50 cm / 20"

Metal-Maßstäbe / Metal Rulers /
 Règles, en métal / Reglas de metal /
 Reguli di acciaio



Maßband, Leinen
 Tape measure, Linen
 Ruban métrique en toile
 Cinta métrica de tela
 Nastro metrico di tela
10.0350
 1,5 m

Maßband, Stahl
 Tape measure, steel
 Ruban métrique en acier
 Cinta métrica de acero
 Nastro metrico metallico
10.0352
 2 m



BERTILLON
10.0370
 Schädel-Messzirkel / Cephalometer /
 Céphalomètre / Cefalómetro / Cefalometro



23.2000 13,5 cm 0 - 35 mm
 Knochenmesszange
 Bone Measuring Caliper / Pince pour
 mesurer os / Pinza para medir huesos
 Pinze per misurare ossi

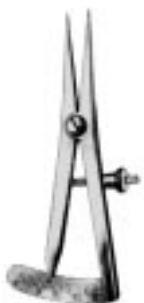

CASTROVIEJO
30.1400
 Zirkel 8 cm 0 -20 mm



CASTROVIEJO
30.1402
 Zirkel 8 cm 0 -15 mm



CASTROVIEJO
30.1408
 Zirkel 16,5 cm 0 -40 mm



CASTROVIEJO
30.1409
 Zirkel 16,5 cm 0 -40 mm



Schieblehre
 Caliper
 Pied à coulisse
 Calibrador
 Calibratore

10.0360
 0-150mm /6"

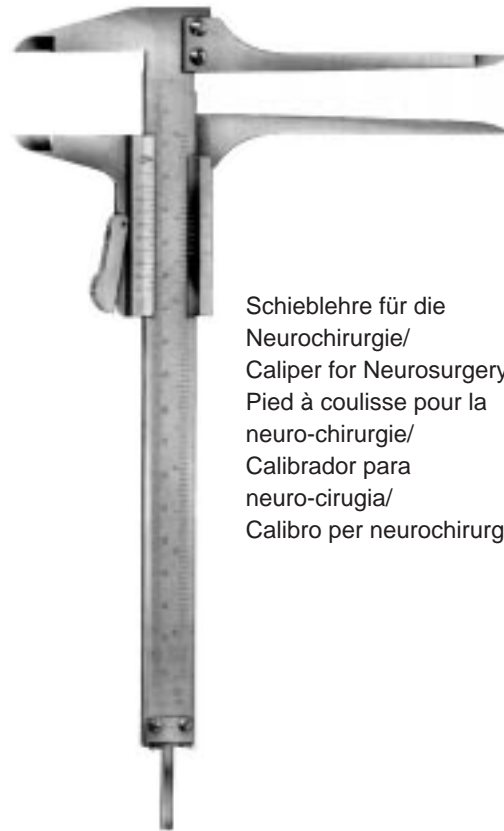

Schieblehre für die
 Neurochirurgie/
 Caliper for Neurosurgery/
 Pied à coulisse pour la
 neuro-chirurgie/
 Calibrador para
 neuro-cirurgia/
 Calibro per neurochirurgia

CASPAR
27.5570



Schraubenmessgerät
 Screw depth gauge
 Appareil pour mesureur vis
 Medidor para tornillos
 Strumenti per misurare viti

24.3071 bis: / up to: / 30 mm
24.3072 jusqu'à: / 50 mm
24.3073 hasta: / fino: 100 mm
24.3074 120 mm



Schieblehre
 Caliper
 Pied à coulisse
 Calibrador
 Calibratore

JAMESON
30.1410
 9,5 cm

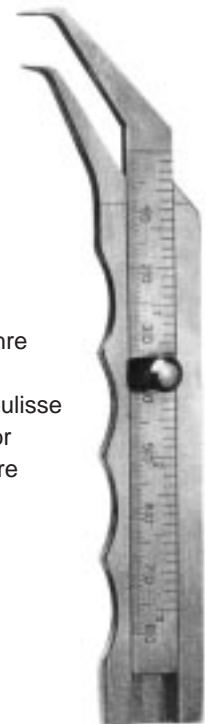

THORPE
30.1415
 12 cm

Beckenzirkel
Pevimeters
Pelvimètres
Pelvimetros
Pelvimetri



MARTIN

56.0010

30 cm

cm/Zoll-Skala / cm/inch scale /
échelle en cm/pouces / escala en
cm/pulg. / scala in cm/pollici



COLLIER

56.0020

30 cm

cm/Zoll-Skala / cm/inch scale /
échelle en cm / pouces / escala
en cm/pulg. / scala in cm/pollici



COLLIN

56.0030

35 cm

cm Skala / cm scale / échelle en
cm / escala en cm / scala in cm

VORBEREITUNG, DERMATOLOGIE
PREPARATION, DERMATOLOGY
PREPARATION, DERMATOLOGIE
PREPARACION, DERMATOLOGIA
PREPARAZIONE, DERMATOLOGIA



Maniküre, Pedicure / Manicure, Pedicure / Manicure, Pédicure / Manicura, Pedicura / Manicure, Pedicure

Nagelzangen / Nail Nippers / Pincès à ongles /
 Pinzas corta-uñas / Tonchesine per unghie 14 cm



58.0501
14 cm



TURNBULL
58.0520 11,5 cm
58.0522 13,5 cm



58.0530
14 cm



58.0540
15 cm



58.0550
13 cm



LITTAUER
58.0551 11 cm
58.0553 13 cm
58.0555 15 cm

Nagelhaut- und Nagelscheren / Cuticle- and Nail Scissors /
 Ciseaux à envies et à ongles / Tijeras cuticulares y para uñas /
 Forbici per la cuticola e unghie



58.0600
10 cm



58.0601
10 cm

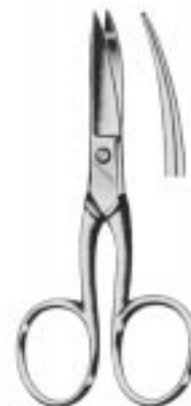

58.0621
10 cm

Maniküre, Pedicure / Manicure, Pedicure / Manicure, Pédicure / Manicura, Pedicura / Manicure, Pedicure

Nagelhautzangen / Cuticle Nippers / Pincès à envies /
Pinzas cuticular / Tronchesine per la cuticola

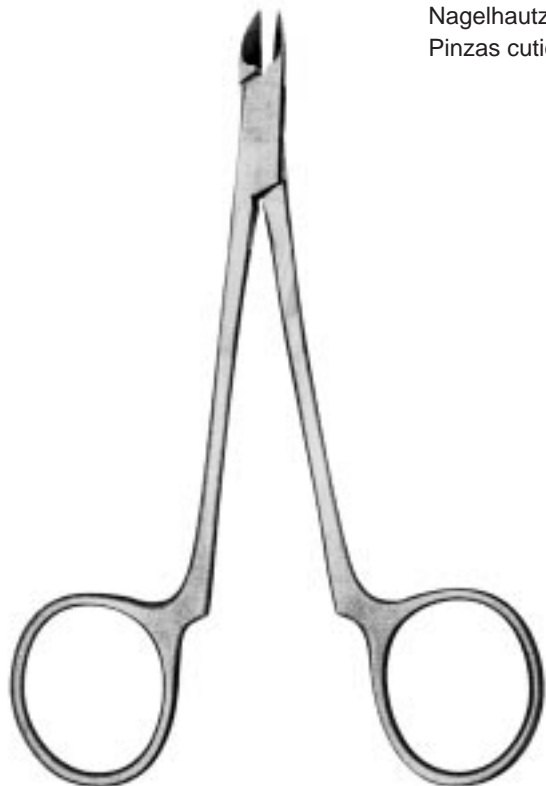

LEMPERT
58.0631
11cm



COHEN
58.0637
10 cm



ILIC
58.0638
14 cm

Schwesterngarnitur / Nurses' Set /
Etui pour infirmières / Surtido para enfermeras /
Necessario per infermiera

Nagelfeilen / Nail-files / Limes à ongles / Limas de uñas / Lime per le unghie



58.0700



58.0710
10 cm



58.0712
12 cm



58.0715
15 cm

Bürstenspender für 20 Bürsten / Dispensers for 20 brushes /
Distributeurs pour 20 brosses / Dispensadores para 20 cepillos /
Dispenser per 20 spazzole

Handwaschbürste / Nail Brush / Brosse à main /
Cepillo a mano / Spazzola a mano



58.1000 SILBER / SILVER / ARGENTE / PLATEADO / ARGENTEO
58.1001 BLAU / BLUE / BLEU / AZUL / AZZURO
58.1002 ROT / RED / ROUGE / ROJO / ROSSO
58.1003 GRÜN / GREEN / VERT / VERDE / VERDE
58.1004 GOLD / GOLD / DORE / DORADO / D'ORO



58.1040

Hauthäkchen / Skin Hooklets
Crochets à peau / Ganchitos para piel /
Uncini cutane

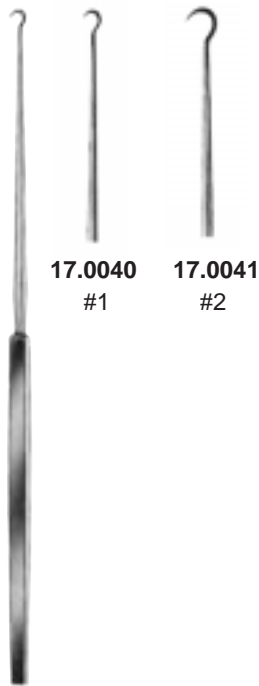

17.0040 #1
17.0041 #2

GILLIES
18 cm



KILNER
58.0010 15,5 cm

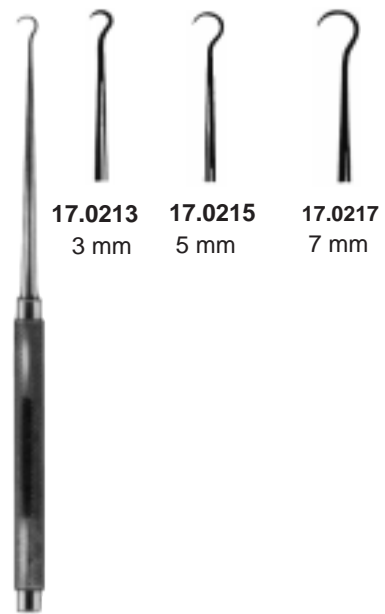

17.0213 3 mm
17.0215 5 mm
17.0217 7 mm

KLEINERT-KUTZ
13 cm

Komedoneninstrumente / Comedone Extractors
Tire-comédons / Saca-comedones / Tiracomedoni

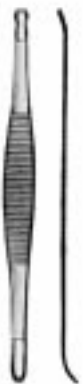

SCHAMBERG
58.0100
10 cm



UNNA
58.0110
ov./ov.



UNNA
58.0120
rd./rd.



KATSCH
58.0130
14 cm



SAALFELD
58.0140
14,5 cm



VIDAL
58.0160
13 cm



UNNA-VIDAL
58.0165

Lupusküretten, Hauttrephinen, Kompressorium
 Lupus Currettes, Dermal Punches, Tourniquet
 Curettes pour les lupus, Trépans cutanés, Compresseur
 Curetas para lupus, Trépanos para piel, Compresor
 Curette per lupus, Trefine cutanee, Compressorio

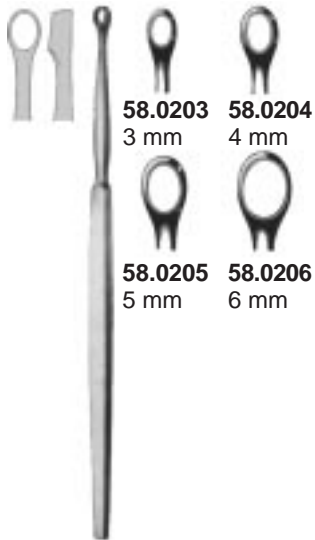

FOX

58.0203
3 mm

58.0204
4 mm

58.0205
5 mm

58.0206
6 mm



PIFFARD
14 cm

58.0210 #1

58.0211 #2

58.0212 #3

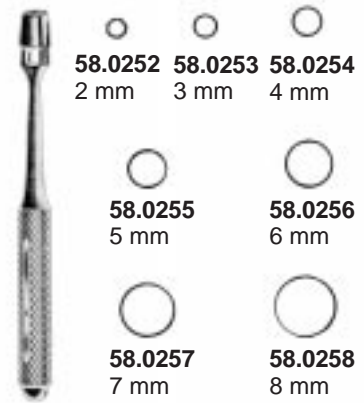

KEYES

58.0252 2 mm

58.0253 3 mm

58.0254 4 mm

58.0255 5 mm

58.0256 6 mm

58.0257 7 mm

58.0258 8 mm

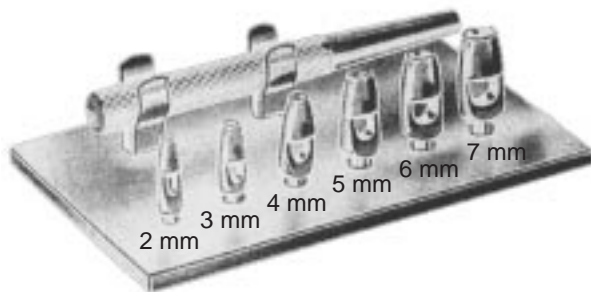

KEYES
58.0260



FELDHEIM
58.0240
10 cm

Kompressorium /
 Tourniquet / Compresseur /
 Compresor / Compressorio

Nagelbohrer komplett
Nail Drill complete
Perceuse à ongles, complète
Taladro para uñas, completo
Perforatore per unghie



58.0309

Satz mit 3 Bohrern für 58.0300
Set of 3 Drills for 58.0300
Jeu de 3 forets p. 58.0300
Juego de 3 brocas para 58.0300
Set con 3 punte per 58.0300

58.0300
mit 3 Bohrern
with 3 drills
avec 3 forets
con 3 taladros
con 3 punte

Nagelausreißzange
Nail extracting Forceps
Pince pour extraire les ongles
Pinza para arrancar uñas
Pinza per estrazione delle unghie



RADOLF

58.0320
14 cm

Nagelspaltzange
Nail Splitter
Pince à fendre ongles
Pinza cortar-uñas hendiduras
Pinza taglianti per fendere unghi



ANVIL

58.0517
14 cm

Nagelspaltscheren
Nail Splitting Scissors
Ciseaux à fendre les ongles
Tijera para hender las uñas
Forbici per fissurare le unghie



58.0621
10 cm



SYSTRUNK
58.0625
13 cm



KÖNIG
58.0650 13 cm
58.0652 15 cm

58.0359



WALTON
58.0350
16 cm

58.0369



58.0360
17 cm

58.0379



WALTON-Select
58.0370
16 cm

für Gold, Silber, Platin, Titan, Stahl
for gold, silver, platinum, titanium, steel
pour or, argent, platine, titane, acier
para oro, plata, platino, titanio, acero
per oro, argento, platino, titanio, acciaio

58.0389



PRO-MED-Select
58.0380
17 cm

NARKOSE
ANAESTHESIA
ANESTHÉSIE
ANESTESIA
ANESTESIA



Zungen- und Kathetereinführungszangen
Tongue Holding- and Catheter Introducing Forceps
Pinces tire-langue et pour introduire les sondes
Pinzas tiralengua y para catéteres
Pinze per lingua e per introdurre le sonde



COLLIN
11.0100
17 cm



YOUNG
11.0110
16 cm



YOUNG
11.0119
Paar
pair
paire
par
paio



MAGILL
11.0300 24 cm
11.0302 20 cm
11.0304 17 cm



McINTOSH

11.1003

Besteck bestehend aus: 11.1016 Batteriegriff (ohne Batterie), 11.1021 McINTOSH Spatel Fig. 1, 11.1022 dito Fig. 2, 11.1023 dito Fig. 3, 11.1027 Etui für 3 Spatel

Set consisting of 11.1016 Battery Handle (without batteries), 11.1021 McINTOSH Blade Fig. 1, 11.1022 dito Fig. 2, 11.1023 dito Fig. 3, 11.1027 Case for 3 blades

Trousse, composée de 11.1016 Manche à piles (sans piles), 11.1021 McINTOSH Spatule Fig. 1, 11.1022 dito Fig. 2, 11.1023 dito Fig. 3, 11.1027 Etui pour 3 spatules

Juego compuesto de: 11.1016 Mango de pila (sin pilas), 11.1021 McINTOSH Hojy Fig. 1, 11.1022 idem Fig. 2, 11.1023 idem Fig. 3, 11.1027 Estuche para 3 hojas

Set completo composto da: 11.1016 Manico per pila 30 mm (senza pila); 11.1021 McIntosh Spatola Fig. 1; 11.1022 idem Fig. 2; 11.1023 idem Fig. 3; 11.1027 astuccio per 3 spatole.



McINTOSH

11.1004

Besteck bestehend aus: 11.1016 Batteriegriff (ohne Batterie), 11.1021 McINTOSH Spatel Fig. 1, 11.1022 dito Fig. 2, 11.1023 dito Fig. 3, 11.1024 dito Fig. 4 11.1028 Etui für 4 Spatel

Set consisting of 11.1016 Battery Handle (without batteries), 11.1021 McINTOSH Blade Fig. 1, 11.1022 dito Fig. 2, 11.1023 dito Fig. 3, 11.1024 dito Fig. 4, 11.1028 Case for 4 blades

Trousse, composée de 11.1016 Manche à piles (sans piles), 11.1021 McINTOSH Spatule Fig. 1, 11.1022 dito Fig. 2, 11.1023 dito Fig. 3, 11.1024 dito Fig. 4, 11.1028 Etui pour 4 spatules

Juego compuesto de: 11.1016 Mango de pila (sin pilas), 11.1021 McINTOSH Hojy Fig. 1, 11.1022 idem Fig. 2, 11.1023 idem Fig. 3, 11.1024 idem Fig. 4, 11.1028 Estuche para 4 hojas

Set completo composto da: 11.1016 Manico per pila 30 mm (senza pila); 11.1021 McIntosh Spatola Fig. 1; 11.1022 idem Fig. 2; 11.1023 idem Fig. 3; 11.1024 idem Fig. 4; 11.1028 astuccio per 4 spatole.



11.1016
 BATTERIEGRIFF 30 mm Ø
 ohne Batterien
 without batteries
 sans piles
 sin pilas
 senza pila



11.1018
 ERSATZBIRNE
 für McIntosh Figur 0 - 1
 für Spatels / for blades / pour
 spatules / para hojas / per
 spatole: Fig, 0 - 1



11.1019
 ERSATZBIRNE
 für Spatel Figur 2 - 4
 für Spatels / for blades / pour
 spatules / para hojas / per
 spatole: Fig, 2 - 4



McINTOSH
11.1020
 55 mm Fig. 0



McINTOSH
11.1021
 75 mm Fig.1



McINTOSH
11.1022
 90 mm Fig. 2



McINTOSH
11.1023
 110 mm Fig. 3



McINTOSH
11.1024
 130 mm Fig. 4



MILLER-BABY
11.1052

Besteck bestehend aus: 11.1016 Batteriegriff (ohne Batterien);
 11.1070 MILLER-BABY Spatel Fig. 0, 11.1071 dito Fig. 1

Set consisting of: 11.1016 Battery handle (without batteries);
 11.1071 MILLER-BABY Spatula Fig. 0, 11.1071 ditto Fig. 1

Trousse, composée de: 11.1016 Manche à piles (sans piles);
 11.1070 spatule MILLER-BABY Fig. 0, 11.1071 ditto Fig. 1

Juego compuesto de: 11.1016 Mango de pilas (sin pilas);
 11.1070 hoja MILLER-BABY Fig. 0, 11.1071 idem Fig. 1

Set completo composto da: 11.1016 Manico per pila 30 mm
 (senza pila); 11.1070 MILLER-BABY spatola Fig. 0, 11.1071
 idem Fig. 1



MILLER

11.1063

Laryngoskop 3 Spateln Figur 1 - 3

Besteck bestehend aus: 11.1016 Batteriegriff (ohne Batterien); 11.1071 MILLER Spatel Fig. 1; 11.1072 dito Fig. 2; 11.1073 dito Fig. 3, Etui

Set consisting of: 11.1016 Battery handle (without batteries); 11.1071 MILLER Spatula Fig. 1; 11.1072 Fig. 2; 11.1073 ditto Fig. 3, case

Trousse, composée de: 11.1016 Manche à piles (sans piles); 11.1071 spatule MILLER Fig. 1; 11.1072 dito Fig. 2; 11.1073 dito Fig. 3, Etui

Juego compuesto de: 11.1016 Mango de pilas (sin pilas); 11.1071 hoja MILLER Fig. 1; 11.1072 idem Fig. 2; 11.1073 idem Fig. 3, Estuche

Set completo composto da: 11.1016 Manico per pila 30 mm (senza pila); 11.1071 MILLER spatola Fig. 1; 11.1072 idem Fig. 2; 11.1073 idem Fig. 3, astucchio

MILLER

11.1064

Laryngoskop 4 Spateln Figur 1 - 4

Besteck bestehend aus: 11.1016 Batteriegriff (ohne Batterien); 11.1071 MILLER Spatel Fig. 1; 11.1072 dito Fig. 2; 11.1073 dito Fig. 3, 11.1074 dito Fig. 4, Etui

Set consisting of: 11.1016 Battery handle (without batteries); 11.1071 MILLER Spatula Fig. 1; 11.1072 Fig. 2; 11.1073 ditto Fig. 3, 11.1074 ditto Fig. 4, case

Trousse, composée de: 11.1016 Manche à piles (sans piles); 11.1071 spatule MILLER Fig. 1; 11.1072 dito Fig. 2; 11.1073 dito Fig. 3, 11.1074 dito Fig. 4, Etui

Juego compuesto de: 11.1016 Mango de pilas (sin pilas); 11.1071 hoja MILLER Fig. 1; 11.1072 idem Fig. 2; 11.1073 idem Fig. 3, 11.1074 idem Fig. 4, Estuche

Set completo composto da: 11.1016 Manico per pila 30 mm (senza pila); 11.1071 MILLER spatola Fig. 1; 11.1072 idem Fig. 2; 11.1073 idem Fig. 3, 11.1074 idem Fig. 4, astucchio

MILLER

11.1065

Laryngoskop 5 Spateln Figur 0 - 4

Besteck bestehend aus: 11.1016 Batteriegriff (ohne Batterien); 11.1070 MILLER Spatel Fig. 0; 11.1071 dito Fig. 1; 11.1072 dito Fig. 2; 11.1073 dito Fig. 3, 11.1074 dito Fig. 4, Etui

Set consisting of: 11.1016 Battery handle (without batteries); 11.1070 MILLER Spatula Fig. 0; 11.1071 Fig. 1; 11.1072 Fig. 2; 11.1073 ditto Fig. 3, 11.1074 ditto Fig. 4, case

Trousse, composée de: 11.1016 Manche à piles (sans piles); 11.1070 spatule MILLER Fig. 0; 11.1071 dito Fig. 1; 11.1072 dito Fig. 2; 11.1073 dito Fig. 3, 11.1074 dito Fig. 4, Etui

Juego compuesto de: 11.1016 Mango de pilas (sin pilas); 11.1070 hoja MILLER Fig. 0; 11.1071 idem Fig. 1; 11.1072 idem Fig. 2; 11.1073 idem Fig. 3, 11.1074 idem Fig. 4, Estuche

Set completo composto da: 11.1016 Manico per pila 30 mm (senza pila); 11.1070 MILLER spatola Fig. 0; 11.1071 idem Fig. 1; 11.1072 idem Fig. 2; 11.1073 idem Fig. 3, 11.1074 idem Fig. 4, astucchio



11.1016
BATTERIEGRIFF 30 mm Ø
ohne Batterien
without batteries
sans piles
sin pilas
senza pila



MILLER
11.1070
55 mm Fig. 0



MILLER
11.1071
80 mm Fig. 1



MILLER
11.1072
130 mm Fig. 2



MILLER
11.1073
170 mm Fig. 3



MILLER
11.1074
180 mm Fig. 4



WISCONSIN-FOREGGER

11.1103

Laryngoskop 3 Spateln

Besteck bestehend aus: 11.1016 Batteriegriff (ohne Batterien); 11.1111 Foregger Spatel Fig. 1; 11.1112 dito Fig. 2; 11.1113 dito Fig. 3, Etui

Set consisting of: 11.1016 Battery handle (without batteries); 11.1111 Foregger Spatula Fig. 1; 11.1112 Fig. 2; 11.1113 ditto Fig. 3, case

Trousse, composée de: 11.1016 Manche à piles (sans piles); 11.1111 spatule Foregger Fig. 1; 11.1112 dito Fig. 2; 11.1113 dito Fig. 3, Etui

Juego compuesto de: 11.1016 Mango de pilas (sin pilas); 11.1111 hoja Foregger Fig. 1; 11.1112 idem Fig. 2; 11.1113 idem Fig. 3, Estuche

Set completo composto da: 11.1016 Manico per pila 30 mm (senza pila); 11.1111 Foregger spatola Fig. 1; 11.1112 idem Fig. 2; 11.1113 idem Fig. 3, astucchio



WISCONSIN-FOREGGER

11.1104

Laryngoskop 4 Spateln

Besteck bestehend aus: 11.1016 Batteriegriff (ohne Batterien); 11.1111 Foregger Spatel Fig. 1; 11.1112 dito Fig. 2; 11.1113 dito Fig. 3, 11.1114 dito Fig. 4, Etui

Set consisting of: 11.1016 Battery handle (without batteries); 11.1111 Foregger Spatula Fig. 1; 11.1112 Fig. 2; 11.1113 ditto Fig. 3, 11.1114 ditto Fig. 4, case

Trousse, composée de: 11.1016 Manche à piles (sans piles); 11.1111 spatule Foregger Fig. 1; 11.1112 dito Fig. 2; 11.1113 dito Fig. 3, 11.1114 dito Fig. 4, Etui

Juego compuesto de: 11.1016 Mango de pilas (sin pilas); 11.1111 hoja Foregger Fig. 1; 11.1112 idem Fig. 2; 11.1113 idem Fig. 3, 11.1114 idem Fig. 4, Estuche

Set completo composto da: 11.1016 Manico per pila 30 mm (senza pila); 11.1111 Foregger spatola Fig. 1; 11.1112 idem Fig. 2; 11.1113 idem Fig. 3, 11.1114 idem Fig. 4, astucchio



WISCONSIN-FOREGGER

11.1111

70 mm Fig. 1



WISCONSIN-FOREGGER

11.1112

90 mm Fig. 2



WISCONSIN-FOREGGER

11.1113

110 mm Fig. 3



WISCONSIN-FOREGGER

11.1114

135 mm Fig. 4





**GEUDEL-NEGUS
 11.1123**

Laryngoskop 3 Spateln
 Besteck bestehend aus: 11.1016 Batteriegriff (ohne Batterien); 11.1132 Geudel-Negus Spatel Fig. 2; 11.1133 dito Fig. 3; 11.1134 dito Fig. 4, Etui

Set consisting of: 11.1016 Battery handle (without batteries); 11.1132 Geudel-Negus Spatula Fig. 2; 11.1133 Fig. 3; 11.1134 ditto Fig. 4, case

Trousse, composée de: 11.1016 Manche à piles (sans piles); 11.1132 spatule Geudel-Negus Fig. 2; 11.1133 dito Fig. 3; 11.1134 dito Fig. 4, Etui

Juego compuesto de: 11.1016 Mango de pilas (sin pilas); 11.1132 hoja Geudel-Negus Fig. 2; 11.1133 idem Fig. 3; 11.1134 idem Fig. 4, Estuche

Set completo composto da: 11.1016 Manico per pila 30 mm (senza pila); 11.1132 Geudel-Negus spatola Fig. 2; 11.1133 idem Fig. 3; 11.1134 idem Fig. 4, astucchio



**GEUDEL-NEGUS
 11.1124**

Laryngoskop 4 Spateln
 Besteck bestehend aus: 11.1016 Batteriegriff (ohne Batterien); 11.1131 Geudel-Negus Spatel Fig. 1; 11.1132 dito Fig. 2; 11.1133 dito Fig. 3; 11.1134 dito Fig. 4, Etui

Set consisting of: 11.1016 Battery handle (without batteries); 11.1131 Geudel-Negus Spatula Fig. 1; 11.1132 ditto Fig. 2; 11.1133 Fig. 3; 11.1134 ditto Fig. 4, case

Trousse, composée de: 11.1016 Manche à piles (sans piles); 11.1131 spatule Geudel-Negus Fig. 1; 11.1132 ditto Fig. 2; 11.1133 ditto Fig. 3; 11.1134 ditto Fig. 4, Etui

Juego compuesto de: 11.1016 Mango de pilas (sin pilas); 11.1131 hoja Geudel-Negus Fig. 1; 11.1132 idem Fig. 2; 11.1133 idem Fig. 3; 11.1134 idem Fig. 4, Estuche

Set completo composto da: 11.1016 Manico per pila 30 mm (senza pila); 11.1131 Geudel-Negus spatola Fig. 1; 11.1132 idem Fig. 2; 11.1133 idem Fig. 3; 11.1134 idem Fig. 4, astucchio



**GEUDEL-NEGUS
 11.1131**
 70 mm Fig. 1



**GEUDEL-NEGUS
 11.1132**
 90 mm Fig. 2



**GEUDEL-NEGUS
 11.1133**
 110 mm Fig. 3



**GEUDEL-NEGUS
 11.1134**
 135 mm Fig. 4





McINTOSH

11.2003

Laryngoskop 3 Spateln

Besteck bestehend aus: 11.2016 Batteriegriff (ohne Batterien); 11.2021 McIntOSH Spatel Fig. 1; 11.2022 dito Fig. 2; 11.2023 dito Fig. 3, 11.1027 Etui

Set consisting of: 11.2016 Battery handle (without batteries); 11.2021 McIntOSH Spatula Fig. 1; 11.2022 Fig. 2; 11.2023 ditto Fig. 3, 11.1027 case

Trousse, composée de: 11.2016 Manche à piles (sans piles); 11.2021 spatule McIntOSH Fig. 1; 11.2022 dito Fig. 2; 11.2023 dito Fig. 3, 11.1027 Etui

Juego compuesto de: 11.2016 Mango de pilas (sin pilas); 11.021 hoja McIntOSH Fig. 1; 11.2022 idem Fig. 2; 11.2023 idem Fig. 3, 11.1027 Estuche

Set completo composto da: 11.2016 Manico per pila 30 mm (senza pila); 11.2021 McIntOSH spatola Fig. 1; 11.2022 idem Fig. 2; 11.2023 idem Fig. 3, 11.1027 astucchio

McINTOSH

11.2004

Laryngoskop 4 Spateln

Besteck bestehend aus: 11.2016 Batteriegriff (ohne Batterien); 11.2021 McIntOSH Spatel Fig. 1; 11.2022 dito Fig. 2; 11.2023 dito Fig. 3, 11.2024 dito Fig. 4; 11.1027 Etui

Set consisting of: 11.2016 Battery handle (without batteries); 11.2021 McIntOSH Spatula Fig. 1; 11.2022 Fig. 2; 11.2023 ditto Fig. 3, 11.2024 ditto Fig. 4; 11.1027 case

Trousse, composée de: 11.2016 Manche à piles (sans piles); 11.2021 spatule McIntOSH Fig. 1; 11.2022 dito Fig. 2; 11.2023 dito Fig. 3, 11.2024 dito Fig. 4; 11.1027 Etui

Juego compuesto de: 11.2016 Mango de pilas (sin pilas); 11.021 hoja McIntOSH Fig. 1; 11.2022 idem Fig. 2; 11.2023 idem Fig. 3, 11.2024 idem Fig. 4; 11.1027 Estuche

Set completo composto da: 11.2016 Manico per pila 30 mm (senza pila); 11.2021 McIntOSH spatola Fig. 1; 11.2022 idem Fig. 2; 11.2023 idem Fig. 3, 11.2024 idem Fig. 4; 11.1027 astucchio



11.2016
BATTERIEGRIFF 30 mm Ø
ohne Batterien
without batteries
sans piles
sin pilas
senza pila



11.2018
Kaltlicht-Ersatzlampe
Fiber optic spare bulb
lumière froide Ampoule de rechange
luz fria bombilla de ricambio
luce fredda lampadina di ricambio



McINTOSH
11.2020
55 mm Fig. 0



McINTOSH
11.2021
70 mm Fig. 1



McINTOSH
11.2022
90 mm Fig. 2



McINTOSH
11.2023
105 mm Fig. 3



McINTOSH
11.2024
130 mm Fig. 4



MILLER

11.2063

Laryngoskop 3 Spateln

Besteck bestehend aus: 11.2016 Batteriegriff (ohne Batterien); 11.2071 Miller Spatel Fig. 1; 11.2072 dito Fig. 2; 11.2073 dito Fig. 3, Etui

Set consisting of: 11.2016 Battery handle (without batteries); 11.2071 Miller Spatula Fig. 1; 11.2072 Fig. 2; 11.2073 ditto Fig. 3, case

Trousse, composée de: 11.2016 Manche à piles (sans piles); 11.2071 spatule Miller Fig. 1; 11.2072 dito Fig. 2; 11.2073 dito Fig. 3, Etui

Juego compuesto de: 11.2016 Mango de pilas (sin pilas); 11.071 hoja Miller Fig. 1; 11.2072 idem Fig. 2; 11.2073 idem Fig. 3, Estuche

Set completo composto da: 11.2016 Manico per pila 30 mm (senza pila); 11.2071 Miller spatola Fig. 1; 11.2072 idem Fig. 2; 11.2073 idem Fig. 3, astucchio

MILLER

11.2064

Laryngoskop 4 Spateln

Besteck bestehend aus: 11.2016 Batteriegriff (ohne Batterien); 11.2071 Miller Spatel Fig. 1; 11.2072 dito Fig. 2; 11.2073 dito Fig. 3; 11.2074 dito Fig. 4, Etui

Set consisting of: 11.2016 Battery handle (without batteries); 11.2071 Miller Spatula Fig. 1; 11.2072 Fig. 2; 11.2073 ditto Fig. 3; 11.2074 ditto Fig. 4, case

Trousse, composée de: 11.2016 Manche à piles (sans piles); 11.2071 spatule Miller Fig. 1; 11.2072 dito Fig. 2; 11.2073 dito Fig. 3; 11.2074 dito Fig. 4, Etui

Juego compuesto de: 11.2016 Mango de pilas (sin pilas); 11.071 hoja Miller Fig. 1; 11.2072 idem Fig. 2; 11.2073 idem Fig. 3; 11.2074 idem Fig. 4, Estuche

Set completo composto da: 11.2016 Manico per pila 30 mm (senza pila); 11.2071 Miller spatola Fig. 1; 11.2072 idem Fig. 2; 11.2073 idem Fig. 3; 11.2074 idem Fig. 4, astucchio



11.2016
BATTERIEGRIFF 30 mm Ø
ohne Batterien
without batteries
sans piles
sin pilas
senza pila



11.2018
Kaltlicht-Ersatzlampe
Fiber optic spare bulb
lumière froide Ampoule de rechange
luz fria bombilla de ricambio
luce fredda lampadina di ricambio



MILLER-BABY
11.2070
55 mm Fig. 0



MILLER-BABY
11.2071
80 mm Fig. 1



MILLER-BABY
11.2072
130 mm Fig. 2



MILLER-BABY
11.2073
170 mm Fig. 3



MILLER-BABY
11.2074
180 mm Fig. 4

SKALPELLE, MESSER
SCALPELS, KNIVES
BISTOURIS, COUTEAUX
BISTURIES, CUCHILLOS
BISTURI, COLTELLI

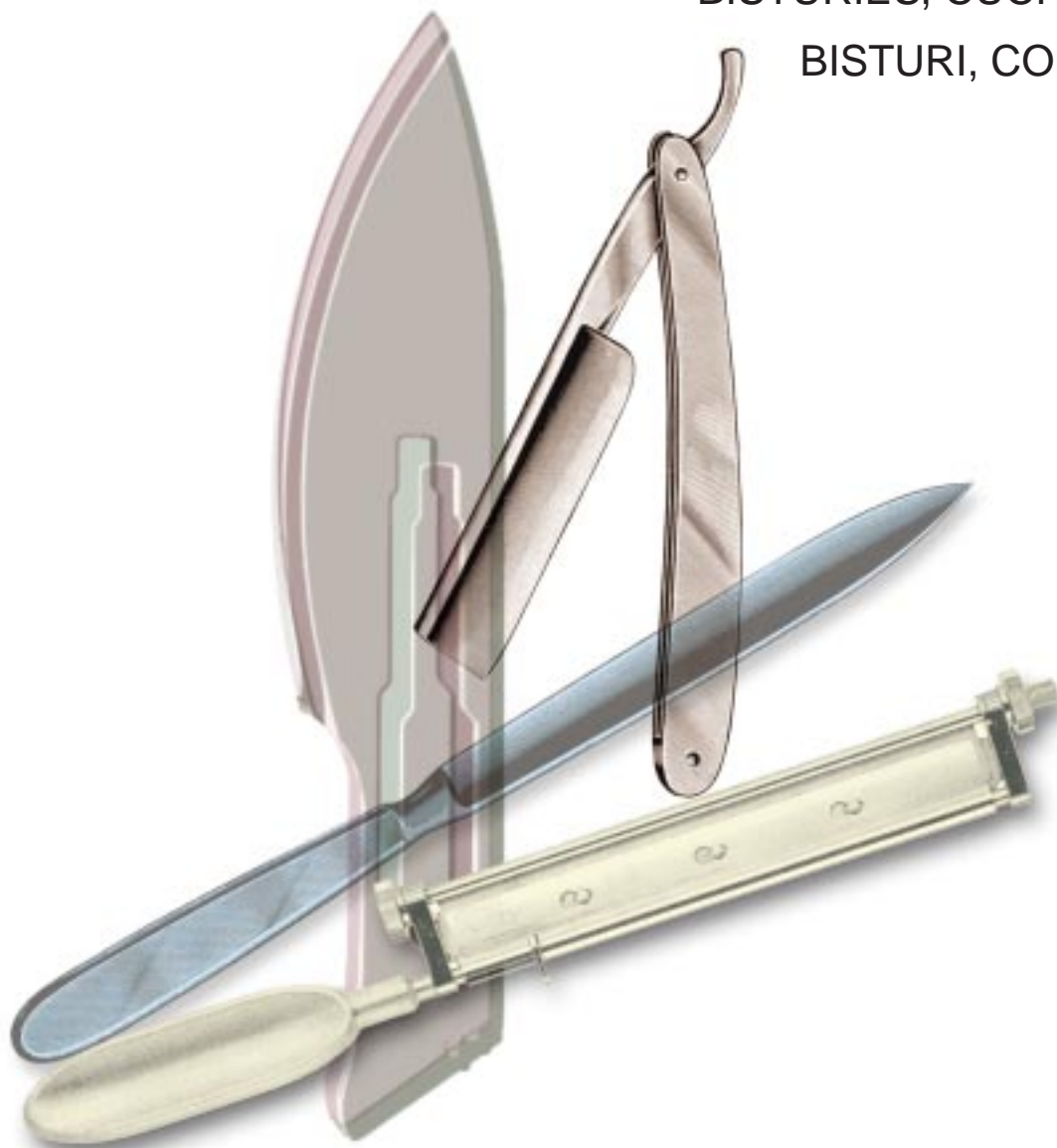

steril, in Packungen à 100
sterile, in packages of 100
stériles, en boîtes de 100
estériles, en cajas de 100
sterili, confezione da 100



12.0010
10



12.0011
11



12.0012
12



12.0013
13



12.0014
14



12.0015
15



12.0016
16



12.0017
17

steril, in Packungen à 100
 sterile, in packages of 100
 stériles, en boîtes de 100
 estériles, en cajas de 100
 sterili, confezione da 100



12.0018
18



12.0019
19



12.0020
20



12.0021
21



12.0022
22



12.0023
23



12.0024
24



12.0025
25



12.0034
34



12.0036
36



12.0042
12 d



12.0044
24 d



12.0045
15 c



12.0046
36 d



ANATOMIE
12.0144
#4 13 cm



ANATOMIE
12.0149
#9 13,5 cm

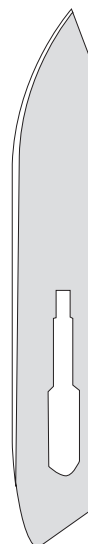

POST-MORTEM
12.0060
60

nicht steril
not sterile
pas stériles
no estériles
non sterile



KLING-EX
12.0070
Skalpelklingen-Abnehmer
Scalpel-blade remover
Oteur-bistouris
Quita hojas
togliere-lame

Mikro-Skalpellklingen und -griffe
 Micro Scalpel Blades and Handles
 Micro lames de bistouris et manches
 Micro hojas de bisturi y mangos
 Micro lame per bisturi e manici

in Packungen à 10 St.
 in packages of 10 ea.
 en boîtes de 10 pièces
 en cajas de 10 c/u
 en scatole di 10 pezzi



12.0061
#61



12.0062
#62



12.0062S
#62S



12.0065
#65



12.0067
#67

Griffe für Klingen
 handles for blades
 manches pour lames
 mangos para hojas
 manici per bisturi

12.0061 - 12.0067



12.0180 100 mm
12.0182 125 mm
12.0184 155 mm
12.0186 180 mm
12.0188 200 mm



LANDOLD
12.0153
 21 cm bajonett



LANDOLD
12.0157
 25 cm bajonett

Skalpellsgriffe mit doppelter Aufnahme
Double Blade Handles
Manches á bistouris pour 2 lames
Mangos de bisturías para 2 hojas
Manici da bisturi per 2 lame



#5

12.0190
16 cm, 1,0 mm
12.0191
16 cm, 1,5 mm
12.0192
16 cm, 2,0 mm



#3

12.0195
12,5 cm, 1,0 mm
12.0196
12,5 cm, 1,5 mm
12.0197
12,5 cm, 2,0 mm

Griffe für Klagen
 Handles for Blades
 Manches pour lames
 Mangos para bisturis
 Manici per bisturi Fig.

Fig. 10,11,12,12d,13,14,15,15c,16,17,

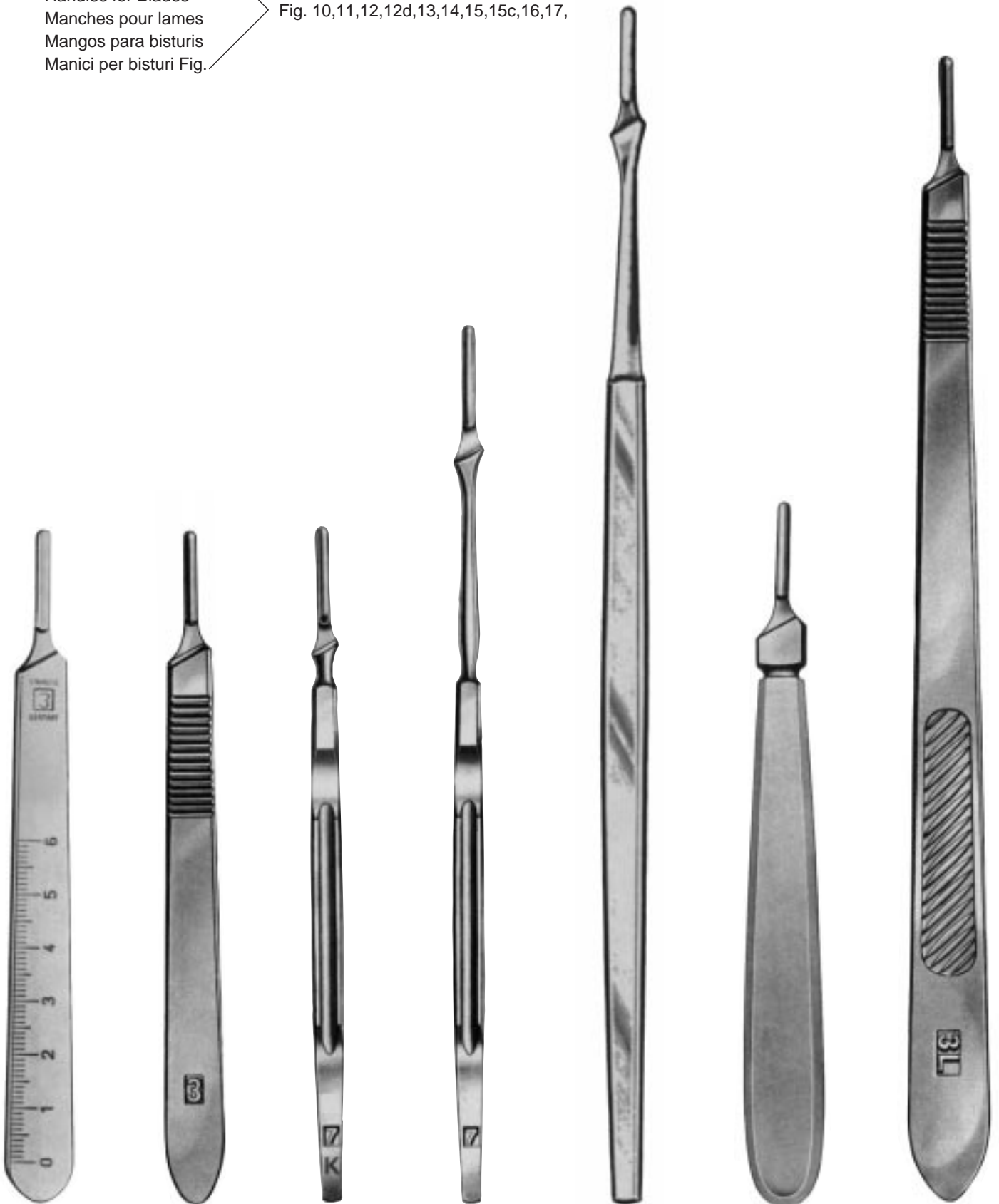

12.0101
 Technical #3

12.0103
 #3 12 cm

12.0106
 #7 K 12,5 cm

12.0107
 #7 16 cm

12.0127
 #7 L 22,5 cm

COLLIN
12.0108
 #8 13 cm

12.0113
 #3 L 21 cm

Griffe für Klingen
 Handles for Blades
 Manches pour lames
 Mangos para bisturis
 Manici per bisturi

Fig. 10,11,12,12d,13,14,15,15c,16,17,



12.0115
 #3 L 20 cm



12.0125
 #5, 16 cm



12.0133
 #3, 21cm



BARRON
12.0163
 #3 13 cm



Kunststoffgriff
 plastic handle
 manche en plastique
 mango plástico
 manico plastica

12.0173
 12,5 cm

Griffe für Klengen
 Handles for Blades
 Manches pour lames
 Mangos para bisturis
 Manici per bisturi

Fig. 18,19,20,21,22,23,24,25,34,36,44,46



12.0105
 # 3/4 16 cm



12.0102
 Technical #4



12.0104
 #4 12 cm



COLLIN
12.0109
 #9 14 cm

Griffe für Klingen
Handles for Blades
Manches pour lames
Mangos para bisturis
Manici per bisturi

Fig. 18,19,20,21,22,23,24,25,34,36,44,46



12.0114
#4 L 21 cm



12.0117
#4 L 20 cm



Kunststoffgriff
plastic handle
manche en plastique
mango plástico
manico plastica

12.0174
13,5 cm



12.0301
#1 15 cm



12.0302
#2 15 cm



12.0303
#3 15,5 cm



12.0304
#4 16 cm



12.0305
#5 16 cm



12.0313
#13 15 cm



12.0314
#14 15 cm



12.0315
#15 16 cm



12.0316
#16 16 cm



12.0317
#17 17 cm



ADAMS
15 cm



12.0331
1



12.0332
2



12.0333
3



12.0334
4



PARKER
14 cm



12.0341
1



12.0342
2



12.0361 #1



12.0362 #2



12.0363 #3



SIMON
20 cm

Amputationsmesser, Zwischenknochenmesser, Beinhautmesser, Resektionsmesser
Amputation Knives, Interosseous Knives, Periosteum Knives, Resection Knives
Couteaux à amputation, interosseux, à resection et à périoste
Cuchillos para amputación, interóseos, para resección y periostio
Coltelli per amputazione, interosseo, resezione e periostio

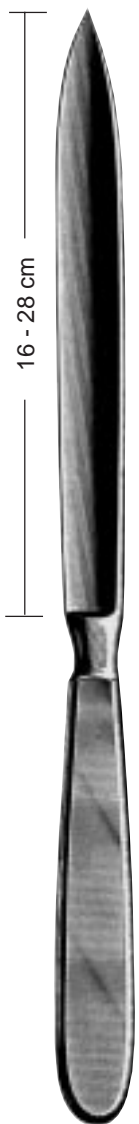

AMPUTATION
12.0506 16 cm
12.0509 19 cm
12.0510 22 cm
12.0511 28 cm

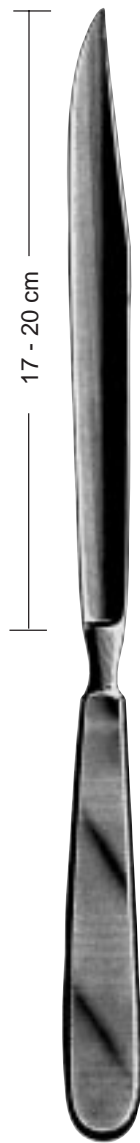

LISTON
12.0517 17 cm
12.0520 20 cm

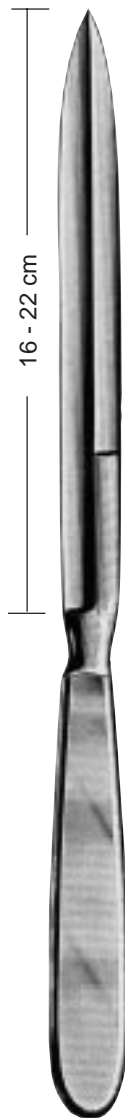

CATLIN
12.0536 16 cm
12.0539 19 cm
12.0542 22 cm



LANGENBECK
12.0552
12 cm



PHALANGEAL
12.0561
10, 5 cm

Hirnmesser
Brain Knives
Couteaux cérébraux
Cuchillos para cerebro
Coltelli per il cervello



PERIOSTEUM
12.0587 6,5 cm



LANGENBECK
12.0590
5,5 cm



LANGENBECK
12.0592
5,5 cm



VIRCHOW
12.0610
Holzschaft
wooden handle
manche en bois
mango de madera
manico di legno



VIRCHOW
12.0612

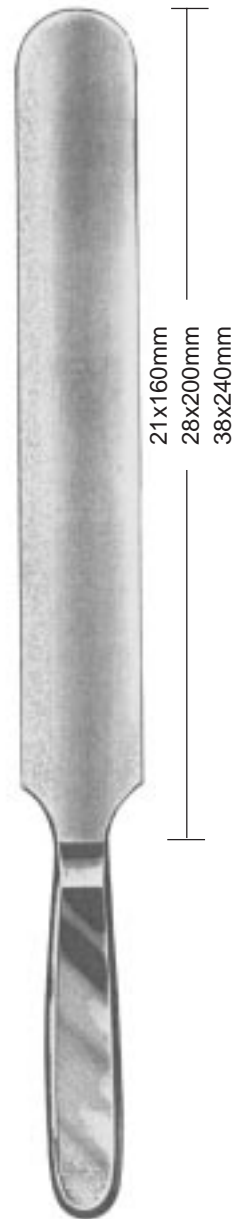

VIRCHOW
12.0700 21x160mm
12.0702 28x200mm
12.0704 38x240mm

Abszeßmesser
Abscess Knife
Bistouri à abcès
Bisturi para abscesos
bisturi per ascessi



VAUGHN
12.2000
12,5 cm



Rasiermesser flach/hohl
Razor Knife flat/hollow
Rasoir plane/concave
Navaja plane/concave
Rasoio piana/concava

12.2100

Abziehstein
Sharpening Stone
Pierre à repasser
Piedra afiladora
Pietra per affilare



ARKANSAS
12.3000



einstellbar von 0,1 - 2,0 mm
adjustable from 0,1 - 2,0 mm
réglable de 0,1 à 2,0 mm
graduabile de 0,1 hasta 2,0 mm
regolabile da 0,1 a 2,0 mm

SCHINK
12.1000
30 cm

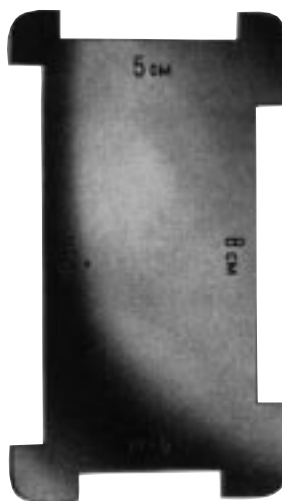

Spannplatte
Skin Straightening Plate
Plaque pour tendre la peau
Placa para extender la piel
Placca per stendere la pele

SCHINK
12.1008



Ersatzklinge
Spare blade
Lame de rechange
Hoja de repuesto
Lama di ricambio

SCHINK
12.1009

komplett mit 1 Klinge und 2 Spannplatten
complete with 1 blade and 2 fixing plates
complet avec 1 lame et 2 plaques pour tendre la peau
completo con 1 hoja y 2 placas para extender la piel
completo con 1 lama y 2 placche per stendere la pele

für Rasierklingen
for Razor Blades
pour lames à rasoir
para hojas de afeitar
per lamette de rasoio



SILVER

12.1020 19 cm
mit 10 Ersatzklingen
with 10 Spare blades
avec 10 lames à rechange
von 10 hojas de repuesto
con 10 lame di ricambio

einstellbar von 0,1 - 4,0 mm
adjustable from 0,1 - 4,0 mm
réglable de 0,1 à 4,0 mm
graduable de 0,1 hasta 4,0 mm
regolabile da 0,1 a 4,0 mm

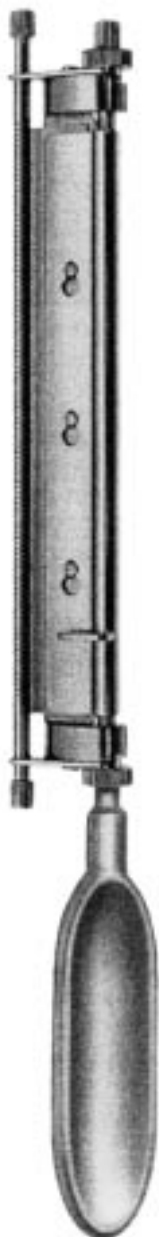

HUMBY

12.1030 30 cm
mit 1 Klinge / with 1 blade / avec 1
lame / von 1 hoja / con 1 lama

einstellbar von 0,1 - 1,5 mm
adjustable from 0,1 - 1,5 mm
réglable de 0,1 à 1,5 mm
graduable de 0,1 hasta 1,5 mm
regolabile da 0,1 a 1,5 mm



12.1039 157 mm
Ersatzklinge
Spare blade
Lame de rechange
Hoja de repuesta
Lama di ricambio



WATSON

12.1050 30 cm
mit 1 Klinge / with 1 blade /
avec 1 lame / von 1 hoja / con
1 lama

einstellbar von 0,1 - 1,5 mm
adjustable from 0,1 - 1,5 mm
réglable de 0,1 à 1,5 mm
graduable de 0,1 hasta 1,5 mm
regolabile da 0,1 a 1,5 mm



12.1059
Ersatzklinge
Spare blade
Lame de rechange
Hoja de repuesta
Lama di ricambio



COBBETT

12.1060 30 cm
mit 1 Klinge / with 1 blade /
avec 1 lame / von 1 hoja / con
1 lama

einstellbar von 0,1 - 1,5 mm
adjustable from 0,1 - 1,5 mm
réglable de 0,1 à 1,5 mm
graduable de 0,1 hasta 1,5 mm
regolabile da 0,1 a 1,5 mm



12.1069
Ersatzklinge
Spare blade
Lame de rechange
Hoja de repuesta
Lama di ricambio



TROUTMAN
12.5000 9 cm



TROUTMAN
12.5001 9 cm



CASTROVIEJO
12.5010 13 cm / 8 mm
12.5012 13 cm / 10 mm



BARRAQUER
12.5020 11 cm



12.5100
Packung = 10
Package = 10
Boîte = 10
Cajita = 10
Scatola = 10

SCHEREN
SCISSORS
CISEAUX
TIJERAS
FORBICI

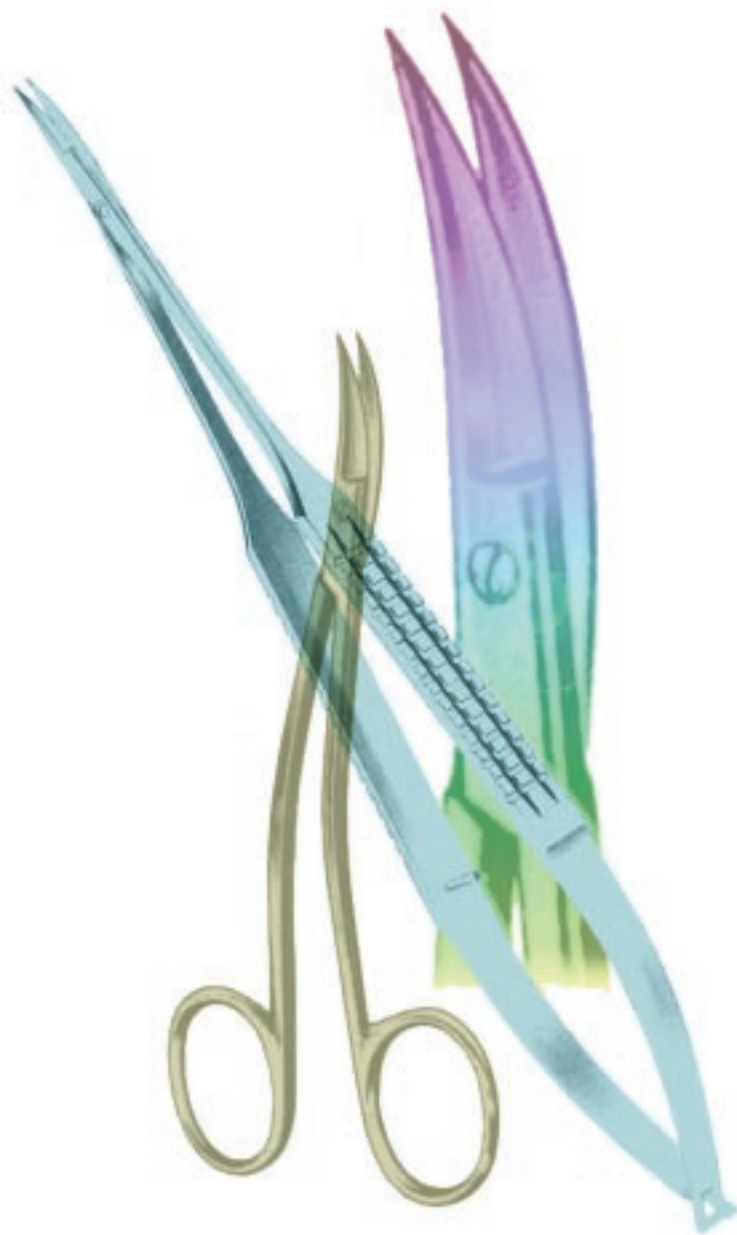

Augenschere "Ribbon type"
Eye Scissors "Ribbon type"
Ciseaux oculaires "Ribbon type"
Tijeras oculares "Ribbon type"
Forbici oculari "Ribbon type"



30.3501

RIBBON-IRIS
30.3500
9 cm



30.3503
10,5 cm

RIBBON-IRIS
30.3502
10,5 cm



RIBBON LIGATURE **RIBBON**
30.3511 **30.3513**
10 cm 11 cm



30.3521
10 cm

RIBBON-STEVENS
30.3520
10 cm

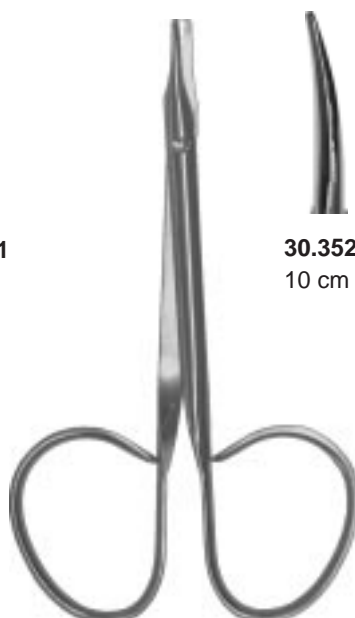

30.3523
10 cm

RIBBON-STEVENS
30.3522
10 cm



30.3541
10,5 cm

RIBBON-STRABISMUS
30.3540
10,5 cm



RIBBON-KAYE
30.3555
10,5 cm

Feine Augenschere
Fine Eye Scissors
Ciseaux oculaires fins
Tijeras oculares finas
Forbici oculari fino

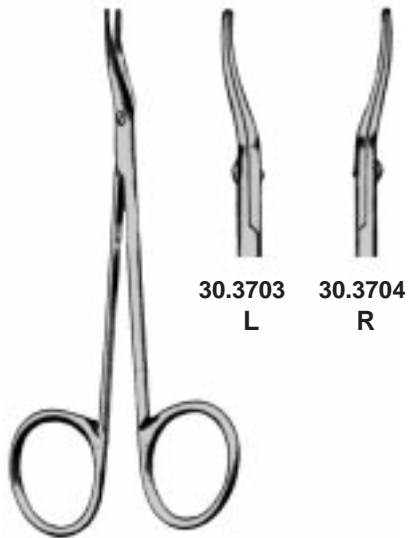

30.3703 L
30.3704 R

AEBLI
10 cm



30.3530 L
30.3531 R

McGUIRE
9,5 cm



30.3552
30.3553

KNAPP
10,5 cm



30.3600
30.3601SC
30.3601
30.3601SC

BONN
9 cm

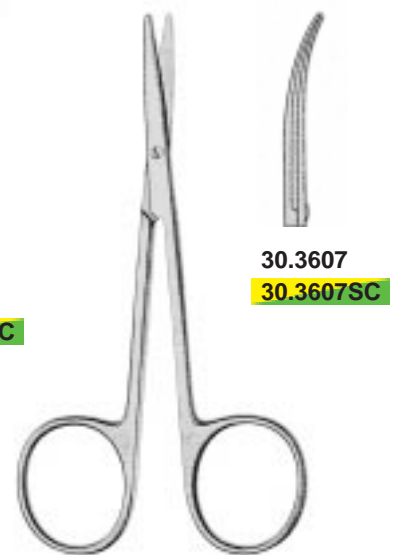

30.3607
30.3607SC

BONN-STRABISMUS
30.3606 9 cm 30.3606SC



IRIS



30.3610
9 cm



30.3611
9 cm



30.3612
10,5 cm



30.3613
10,5 cm

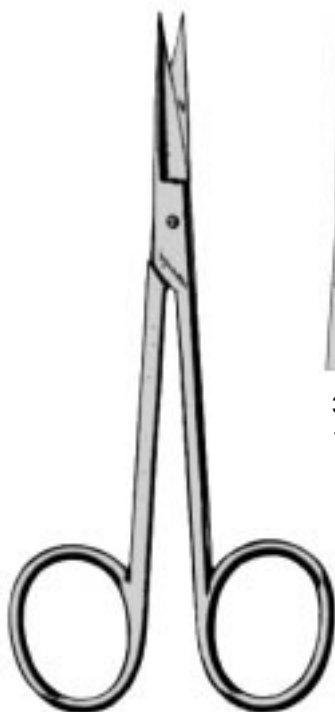

IRIS



30.3614
11,5 cm



30.3615
11,5 cm



WILMER
30.3620
10 cm



GRAEFE
30.3622
10 cm

Enukleationsscheren
Enucleation Scissors
Ciseaux à énucléation
Tijeras para enucleación
Forbici per enucleazione

Skleratomiescheren
Sclerotomy Scissors
Ciseaux à sclérotomie
Tijeras para esclerotomia
Forbici per sclerotomia

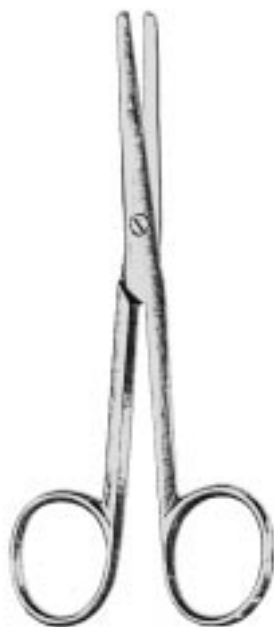

30.3660
13 cm



30.3661



30.3663



LA GRANGE
11,5 cm



30.3671
gezahnt
serrated
dentelée
dentada
dentate



30.3673
glatt
smooth
lisse
liso
piatta



MICRO-SCHERE
 30.3902
 10 cm



MICRO-SCHERE
 30.3903
 10 cm



NOYES
 12 cm



30.3910



30.3911



30.3912



30.3914



30.3915



30.3917



30.3918



aufgewinkelt
 angled up
 coudeés vers le haut
 acodadas hacia arriba
 angolate verso sopra



WECKER
11 cm



30.3920

30.3922

30.3924



BARRAQUER
5,5 cm

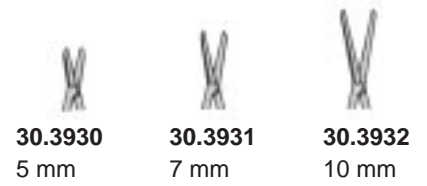

30.3930
5 mm

30.3931
7 mm

30.3932
10 mm



BARRAQUER
30.3936
11 cm



L



R



BARRAQUER
30.3938
11 cm



ONG
8,5 cm



30.3944



30.3945



WESTCOTT
11 cm



30.3951



30.3953

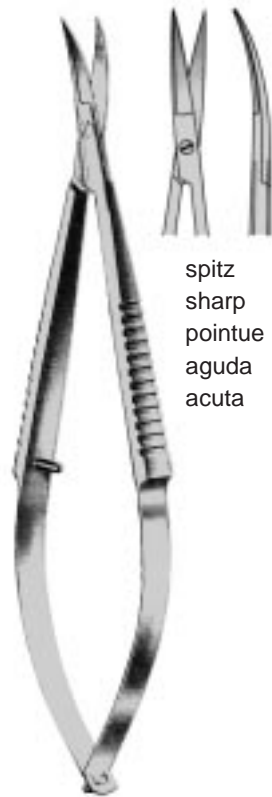

spitz
 sharp
 pointue
 aguda
 acuta

CASTROVIEJO
 30.3961
 11 cm

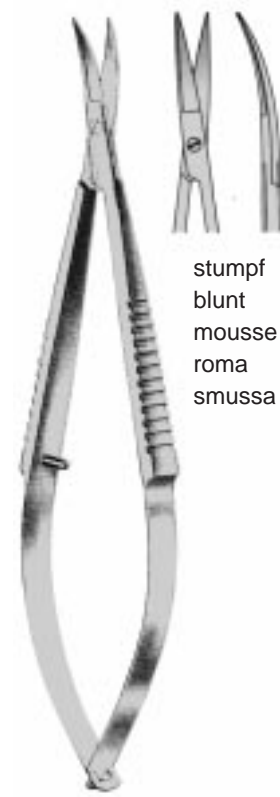

stumpf
 blunt
 mousse
 roma
 smussa

CASTROVIEJO
 30.3963
 11 cm



CASTROVIEJO
 30.3970
 11 cm



CASTROVIEJO
 30.3971



CASTROVIEJO
 30.3973



CASTROVIEJO
 30.3974



TROUTMAN
30.3975
10 cm



TROUTMAN
30.3977
10 cm



KATZIN-BARRAQUER
30.4011
10 cm



KATZIN-BARRAQUER
30.4013
10 cm



KATZIN
30.4015
11 cm



KATZIN
30.4017
11 cm

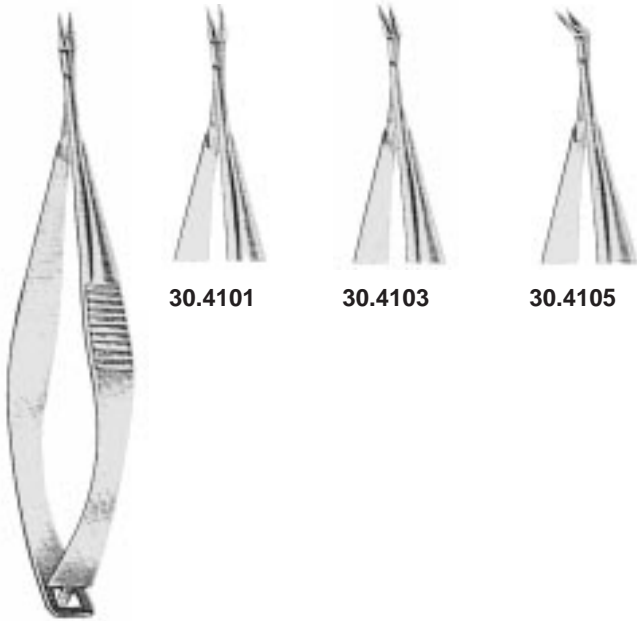

30.4101

30.4103

30.4105

VANNAS
 30.4100
 8 cm

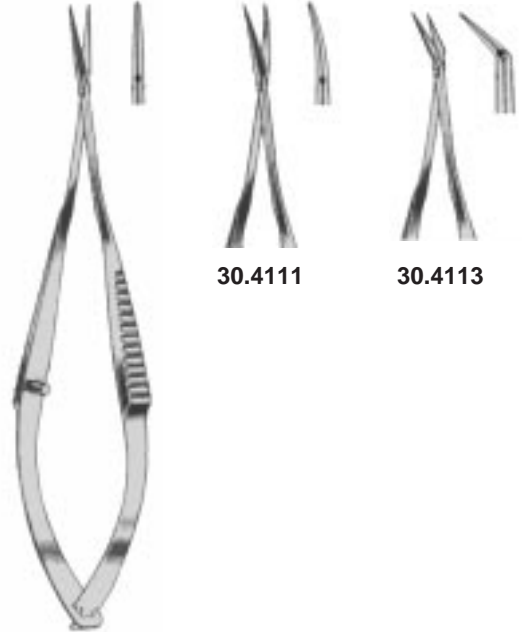

30.4111

30.4113

VANNAS-TÜBINGEN
 30.4110
 8,5 cm



30.4120

30.4121

COHAN-VANNAS
 5,7 cm



CASTROVIEJO
 30.4143
 9,5 cm



CASTROVIEJO
 30.4145
 9,5 cm



AEBLI
 30.4147
 10 cm

Vitrektomie Scheren
Vitreotomy Scissors
Ciseaux à Vitrectomie
Tijeras para vitrectomia
Forbici per vitrectomia

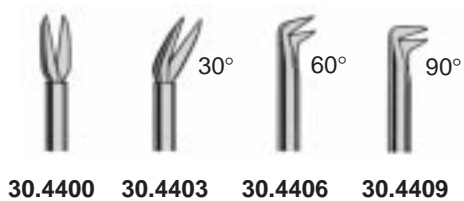
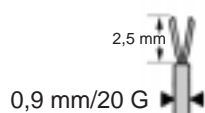

VITREKTOMIE
15 cm



28.2110
15,5 cm

VANNAS-MIKRO



28.2111
15,5 cm



28.2112
18,5 cm

VANNAS-MIKRO



28.2113
18,5 cm



28.2114
23 cm

VANNAS-MIKRO



28.2115
23 cm



VANNAS-MIKRO



28.2100 12,5 cm / Ø 7 mm
gerade
straight
droit
recto
retto

28.2101 12,5 cm / Ø 7 mm
gebogen
curved
courbe
curvo
curvo



VANNAS-MIKRO



28.2102
15 cm
Ø 8 mm
28.2104
18cm



28.2103
15 cm
Ø 8 mm
28.2105
18 cm



28.2122
15 cm / Ø 8 mm
gerade / straight /
droit / recto / retto



28.2123
15 cm / Ø 8 mm
gebogen / curved /
courbe / curvo /
curvo



28.2133
15 cm / Ø 8 mm
gebogen / curved /
courbe / curvo /
curvo

stumpf / blunt /
mousses / romas /
smusse



28.2120
12,5 cm / Ø 7mm
gerade / straight
droit / recto / retto



28.2121
12,5 cm / Ø 7 mm
gebogen / curved
courbe / curvo / curvo



28.2124
18 cm / Ø 8 mm
gerade / straight
droit / recto / retto

28.2125
18 cm / Ø 8 mm
gebogen / curved
courbe / curvo / curvo



28.2150 (GYN)
18 cm / Ø 8 mm
gerade / straight
droit / recto / retto

28.2151 (GYN)
18 cm / Ø 8 mm
gebogen / curved
courbe / curvo / curvo



28.2200
18 cm 25°



28.2201
18 cm 45°



28.2202
18 cm 60°



28.2203
18 cm 90°



28.2204
18 cm 125°



28.2210
18 cm 25°



28.2211
18 cm 45°

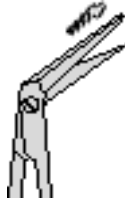

28.2212
18 cm 60°

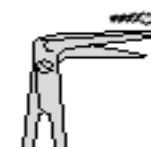

28.2213
18 cm 90°



28.2214
18 cm 125°

mit 1 geknöpften Blatt / 1 probe-pointed blade / avec 1 lame boutonée / con una punta botonada / con 1 lama abbottona



ARTERIOTOMY

TITANIUM



18 cm



28.2460
28.2460T
 25°



28.2470
28.2470T
 25°



28.2461
28.2461T
 45°



28.2471
28.2471T
 45°



28.2462
28.2462T
 60°



28.2472
28.2472T
 60°



28.2463
28.2463T
 90°



28.2473
28.2473T
 90°



28.2464
28.2464T
 125°



28.2474
28.2474T
 125°

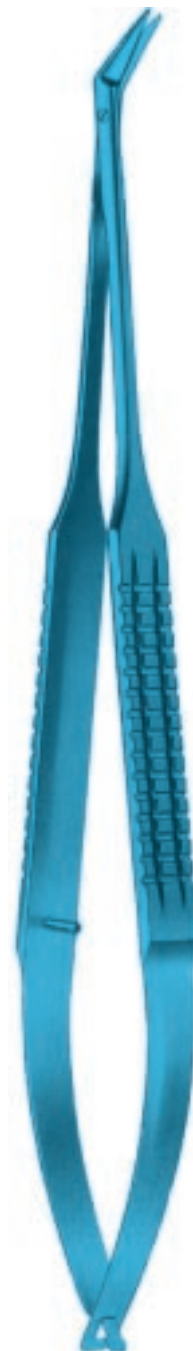

18 cm

mit 1 geknöpften Blatt
 1 probe-pointed blade
 1 lame boutonée
 1 punta botonada
 1 lame abbottona



18 cm



28.2480
25°



28.2481
45°



28.2482
60°



28.2483
90°



28.2484
125°



28.2490
25°



28.2491
45°



28.2492
60°



28.2493
90°



28.2494
125°

mit 1 geknöpften Blatt / 1 probe-pointed blade
avec 1 lame boutonée / con una punta botonada / con 1 lama abbottona



JACOBSON
16 cm



28.2220



28.2221



JACOBSON
19 cm



28.2222



28.2223



28.2225



MILLES
16 cm



28.2230



28.2231

gezahnt
serrated
dentelées
dentada
dentate



18,5 cm



28.2310



28.2311



28.2313



28.2315



23 cm



28.2350



28.2351

Venenschere
Vein Scissors
Ciseaux pour veines
Tijera para venas
Forbici per vene



BIEMER
28.2400
13 cm

TITANIUM



28.2560
28.2560T
15 cm
28.2562
28.2562T
18 cm
28.2564
28.2564T
21 cm
28.2566
23 cm



28.2561
28.2561T
15 cm
28.2563
28.2563T
18 cm
28.2565
28.2565T
21 cm
28.2567
23 cm





28.2600 16,5 cm
28.2602 20,0 cm



28.2601 16,5 cm
28.2603 20,0 cm



28.2605 20,0 cm



28.2608 20,0 cm



28.2609 20,0 cm



28.2620 22,5 cm



28.2623 22,5 cm
28.2625 24,5 cm



28.2624 22,5 cm

28.2622 22,5 cm
 gezahnt
 serrated
 dentelées
 dentada
 dentate



28.2628 22,5 cm



28.2629 22,5 cm



28.2640 22,5 cm



28.2641 22,5 cm

VANNAS



NAGEL

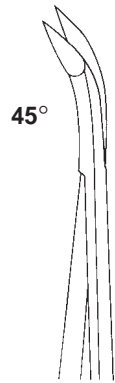

45°

28.2656 20,0 cm



45°

28.2657 20,0 cm

geknöpft
button-end
boutonnée
abotonada
con 1 lama abbottona



125°

28.2659 20,0 cm



VANNAS
 28.2714 12 cm
 28.2718 16 cm



VANNAS
 28.2715 12 cm
 28.2719 16 cm



VANNAS
 28.2711 12 cm



YASARGIL
 28.2712 12 cm
 28.2716 16 cm
 28.2722 18,5 cm



YASARGIL
 28.2713 12 cm
 28.2717 16 cm
 28.2723 18,5 cm



POTTS-YASARGIL
 28.2724 18,5 cm



MILLES
 28.2720 16 cm

gezahnt/serrated
 dentelés/dentada
 dentate



MILLES
 28.2721 16 cm

gezahnt/serrated
 dentelés/dentada
 dentate















BIEMER
 28.2728 13 cm

Venenschere
 Vein Scissors
 Ciseaux pour veines
 Tijera para venas
 Forbici per vene



17,5 cm

	Mikro-Scheren micro-scissors micro-ciseaux micro-tijeras micro-forbici	Mikro-Scheren fein micro-scissors fine micro-ciseaux fins micro-tijeras fino micro-forbici fini
gerade straight droites recta rette	 28.4010	 28.4040
gerade horizontal straight horizontal coupant horizontal recta horizontal rette orizzontale	 28.4012	 28.4042
aufgebogen curved up courbe vers le haut curva hacia arriba curva in alto	 28.4013	 28.4043
aufgebogen horizontal curved up horizontal coupant horizontal, courbe sur le plat curva hacia arriba horizontal curva in alto orizzontale	 28.4015	 28.4045
nach rechts gebogen curved to right courbe à droit curva a la derecha curva destra	 28.4017	 28.4047
nach links gebogen curved to left courbe à gauche curva a la izquierda curva sinistra	 28.4019	 28.4049
gerade 8 mm straight 8 mm droites 8 mm recta 8 mm retta 8 mm	 28.4020	

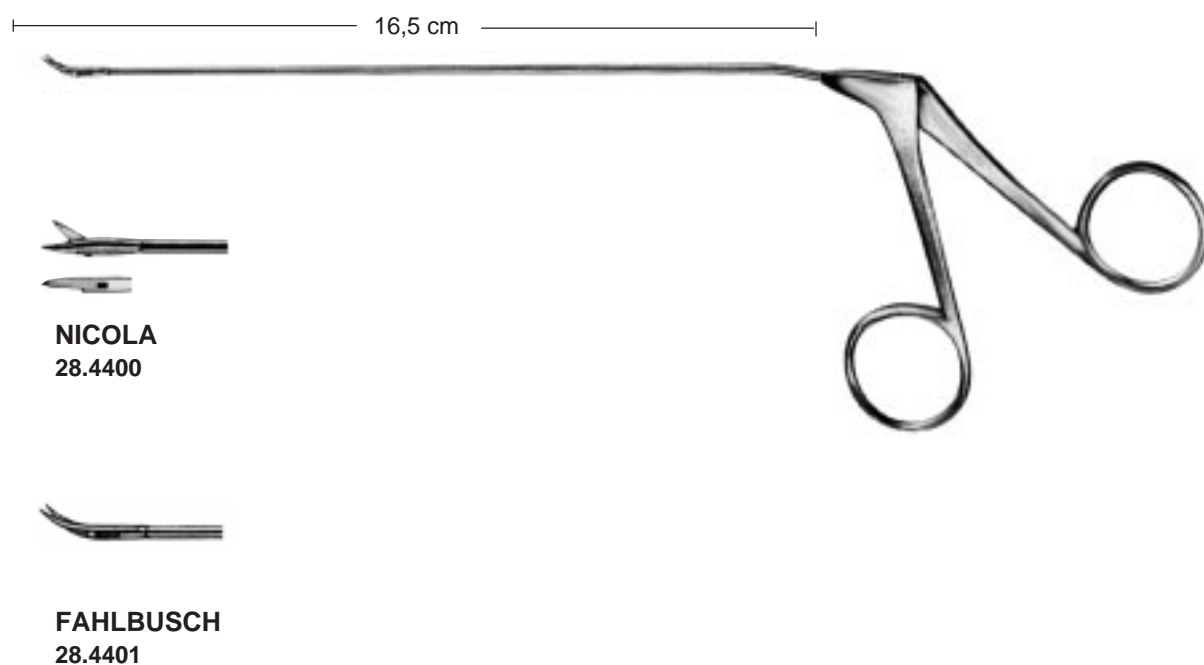
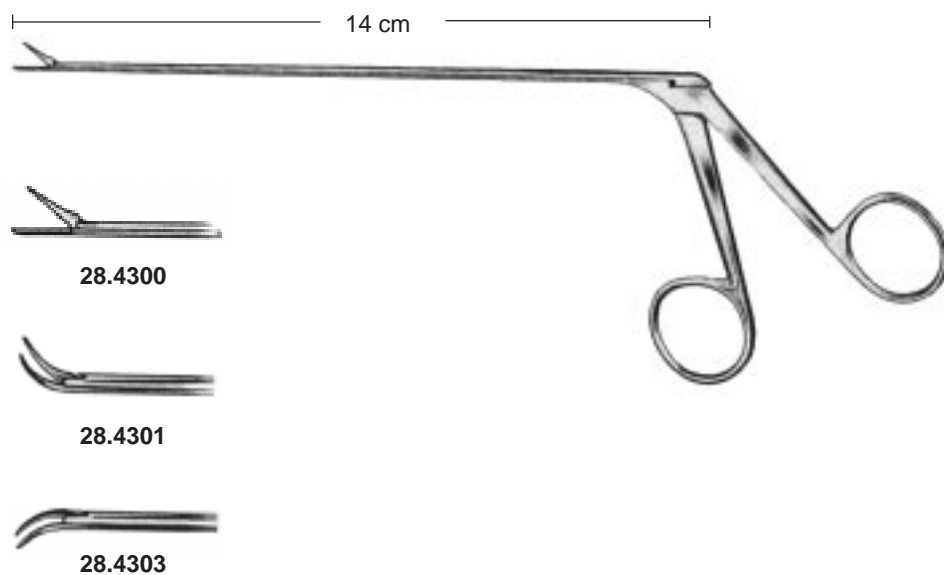



IRIS

- 13.0010 9,0 cm
- 13.0010SC** 9,0 cm
- 13.0012 10,5 cm
- 13.0012SC** 10,5 cm
- 13.0014 11,5 cm
- 13.0014SC** 11,5 cm



IRIS

- 13.0011 9,0 cm
- 13.0011SC** 9,0 cm
- 13.0013 10,5 cm
- 13.0013SC** 10,5 cm
- 13.0015 11,5 cm
- 13.0015SC** 11,5 cm



IRIS

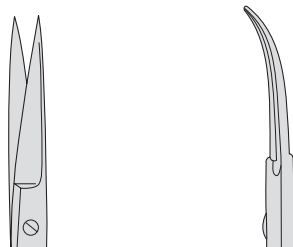

- 13.0012L 10,5 cm
- 13.0012LSC** 10,5 cm
- 13.0013L 10,5 cm
- 13.0013LSC** 10,5 cm

linkshändig / left handed /
pour gaucher / para zurdo / per mano sinistra

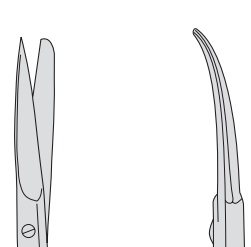

- 13.0022 10 cm
- 13.0023 10 cm



IRIS

mit grossen Ringen
 with large rings
 avec anneaux larges
 con anillos grandes
 con anelli grandi



13.0032 10 cm



13.0033 10 cm

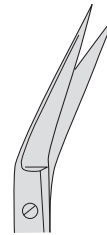

13.0041 9,0 cm

13.0043 10,5 cm

13.0043SC 10,5 cm

13.0045 11,0 cm

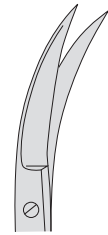

WALKER

13.0051 9,0 cm

13.0053 10,5 cm

13.0055 11,5 cm



STRABISMUS

11,5 cm



13.0060

13.0060SC



13.0061

13.0061SC



STRABISMUS

13.0062 11,5 cm



STRABISMUS

13.0063 11,5 cm



12,5 cm



13.0064



13.0065



13.0066



13.0067



13.0068



13.0069



13.0070
11 cm

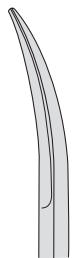

13.0071
11 cm



STEVENS



13.0076



13.0077



10,5 cm 13.0078



13.0079

13.0080

13.0081

11,5 cm

13.0082

13.0083

13.0080SC

13.0081SC

11,5 cm

13.0082SC

13.0083SC



Präparierschere
 Dissecting Scissors
 Ciseaux à dissection
 Tijera para disección
 Forbice per dissezione

POTTS
13.0089
 14 cm



DEAVER

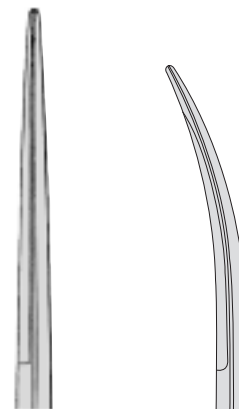

13.0100 13 cm **13.0101**
13.0102 14 cm **13.0103**

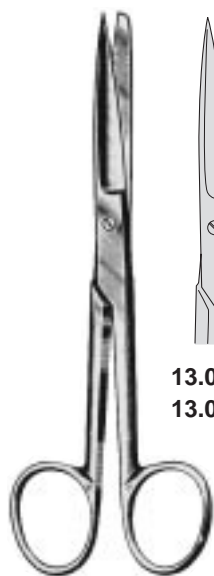

DEAVER

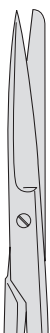

13.0110 13 cm
13.0112 14 cm

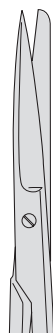

13.0111
13.0113

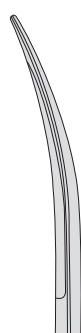

DEAVER



13.0122 14 cm



13.0123





MIXTER
13.0130
15 cm



MIXTER
13.0131
15 cm



KELLY
13.0140
glatt / smooth
lisse / lisa / liscio
13.0146
gezahnt / serrated
dentées / dentadas / dentata



KELLY
13.0140SC
gerade / straight
droits / recta/ retto

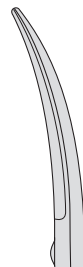

KELLY
13.0141 16 cm

13.0141SC 16 cm
glatt / smooth
lisse / lisa / liscio
13.0147
gezahnt / serrated
dentées / dentadas / dentata



INCISION
13.0292 13,0 cm
13.0294 14,5 cm



GRAZIL

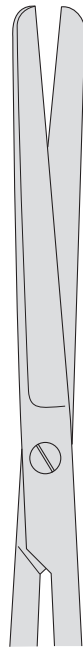

13.0152 13 cm
13.0154 14,5 cm

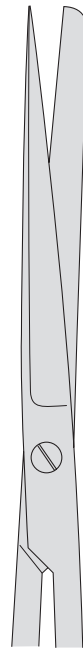

13.0162 13 cm
13.0164 14,5 cm

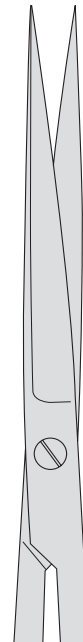

13.0172 13 cm
13.0174 14,5 cm



GRAZIL

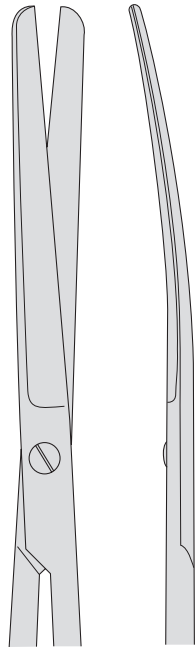

13.0153 13 cm
13.0155 14,5 cm

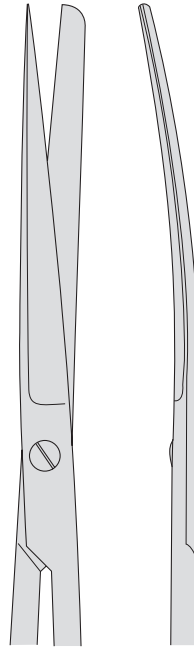

13.0163 13 cm
13.0165 14,5 cm

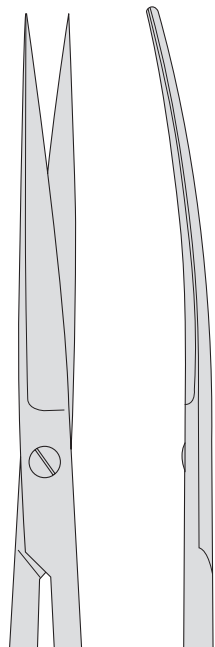

13.0173 13 cm
13.0175 14,5 cm

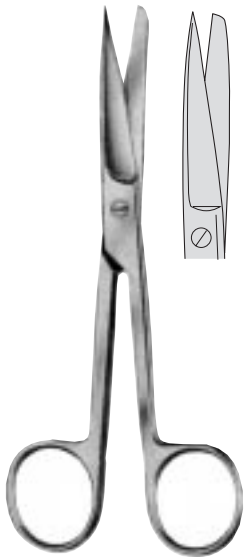

13.0300 11,5 cm
13.0302 13,0 cm
13.0302SC 13,0 cm
13.0304 14,5 cm
13.0304SC 14,5 cm
13.0306 15,5 cm
13.0308 16,5 cm
13.0308SC 16,5 cm
13.0310 18,5 cm
13.0312 20,0 cm



13.0304L 14,5 cm
linkshändig
left-handed
pour gaucher
para zurdo
per mano sinistra



13.0394L 14,5 cm
gezahnt
serrated
dentées
dentadas
dentata



13.0330 11,5 cm
13.0330SC 11,5 cm
13.0332 13,0 cm
13.0334 14,5 cm
13.0334SC 14,5 cm
13.0336 15,5 cm
13.0338 16,5 cm
13.0340 18,5 cm
13.0342 20,0 cm

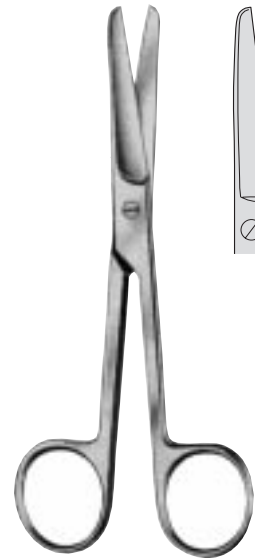

13.0350 11,5 cm
13.0352 13,0 cm
13.0352SC 13,0 cm
13.0354 14,5 cm
13.0354SC 14,5 cm
13.0356 15,5 cm
13.0358 16,5 cm
13.0358SC 16,5 cm
13.0360 18,5 cm
13.0360SC 18,5 cm
13.0362 20,0 cm

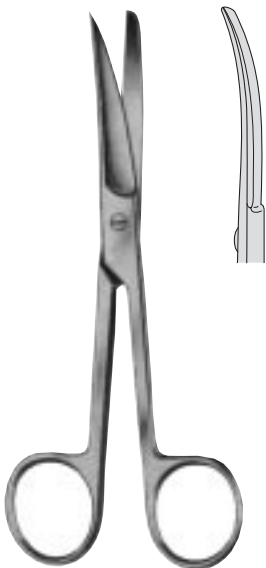

13.0301 11,5 cm
13.0303 13,0 cm
13.0305 14,5 cm
13.0307 15,5 cm
13.0309 16,5 cm
13.0311 18,5 cm
13.0313 20,0 cm

13.0301SC
13.0303SC
13.0305SC
13.0309SC

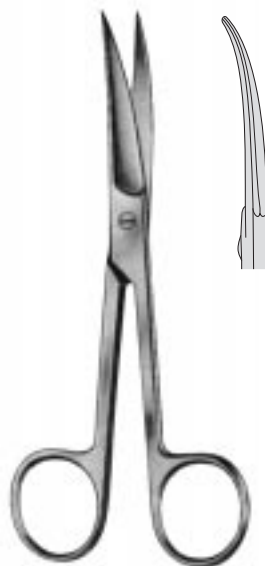

13.0331 11,5 cm
13.0333 13,0 cm
13.0335 14,5 cm
13.0337 15,5 cm
13.0339 16,5 cm
13.0341 18,5 cm
13.0343 20,0 cm

13.0333SC
13.0335SC

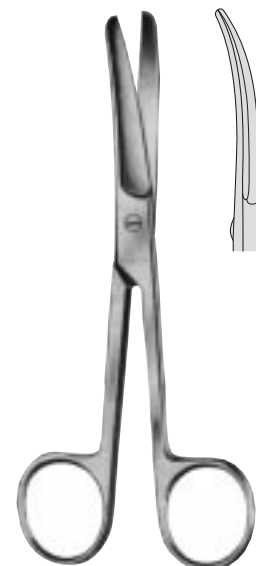

13.0351 11,5 cm
13.0353 13,0 cm
13.0355 14,5 cm
13.0357 15,5 cm
13.0359 16,5 cm
13.0361 18,5 cm
13.0363 20,0 cm

13.0355SC
13.0363SC



MAYO

- | | |
|------------------|---------|
| 13.0400 | 14,5 cm |
| 13.0400SC | 14,5 cm |
| 13.0402 | 15,5 cm |
| 13.0402SC | 15,5 cm |
| 13.0404 | 17,0 cm |
| 13.0404SC | 17,0 cm |
| 13.0406 | 20,0 cm |
| 13.0406SC | 20,0 cm |
| 13.0408 | 23,0 cm |
| 13.0408SC | 23,0 cm |

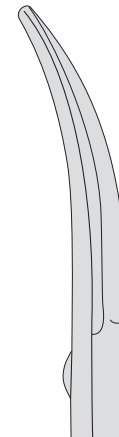

- | | |
|------------------|---------|
| 13.0401 | 14,5 cm |
| 13.0401SC | 14,5 cm |
| 13.0403 | 15,5 cm |
| 13.0403SC | 15,5 cm |
| 13.0405 | 17,0 cm |
| 13.0405SC | 17,0 cm |
| 13.0407 | 20,0 cm |
| 13.0407SC | 20,0 cm |
| 13.0409 | 23,0 cm |
| 13.0409SC | 23,0 cm |



MAYO-STILLE

- | | |
|------------------|---------|
| 13.0432 | 15,0 cm |
| 13.0432SC | 15,0 cm |
| 13.0434 | 17,0 cm |
| 13.0434SC | 17,0 cm |
| 13.0436 | 19,5 cm |
| 13.0438 | 21,0 cm |

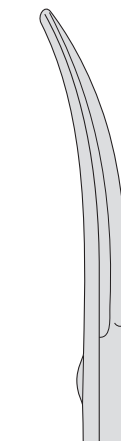

- | | |
|------------------|---------|
| 13.0433 | 15,0 cm |
| 13.0433SC | 15,0 cm |
| 13.0435 | 17,0 cm |
| 13.0435SC | 17,0 cm |
| 13.0437 | 19,5 cm |
| 13.0439 | 21,0 cm |

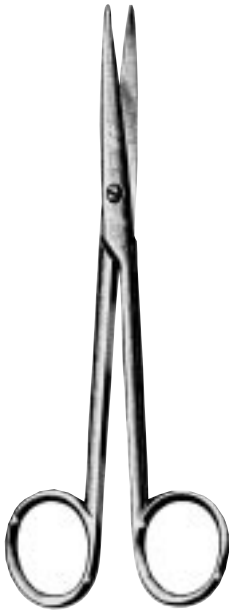

MAYO-LEXER
13.0440 16,5 cm
13.0440SC 16,5 cm

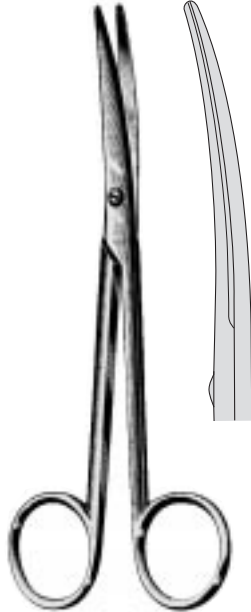

MAYO-LEXER
13.0441 16,5 cm
13.0441SC 16,5 cm



MAYO-NOBLE

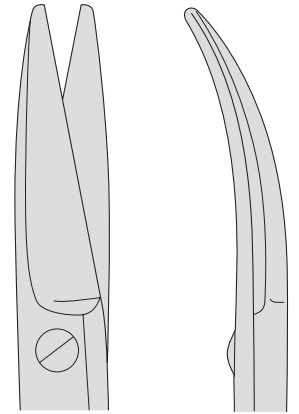

13.0462 17 cm 13.0463 17 cm

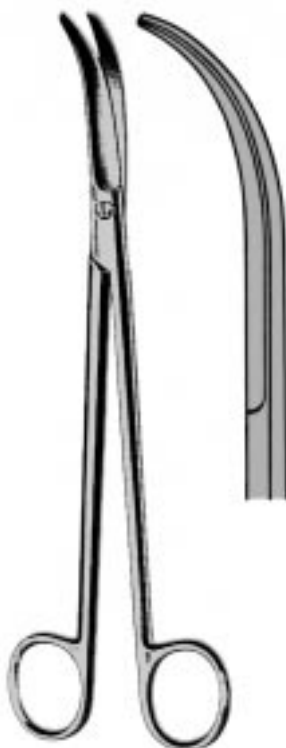

JÖRGENSON
13.0541 23 cm

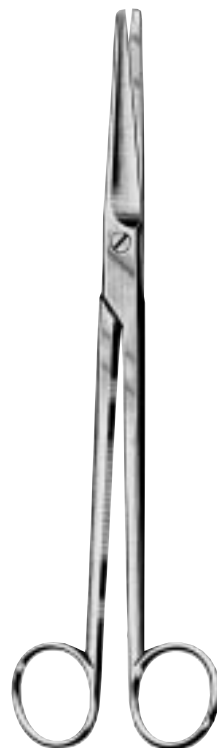

MAYO-HARRINGTON



13.0550 23 cm
13.0554 28 cm
13.0554SC 28 cm

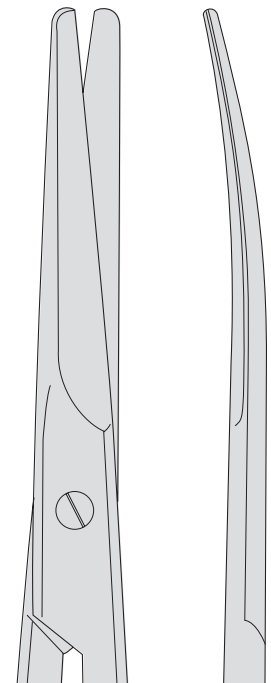

13.0551 23 cm
13.0555 28 cm
13.0555SC 28 cm

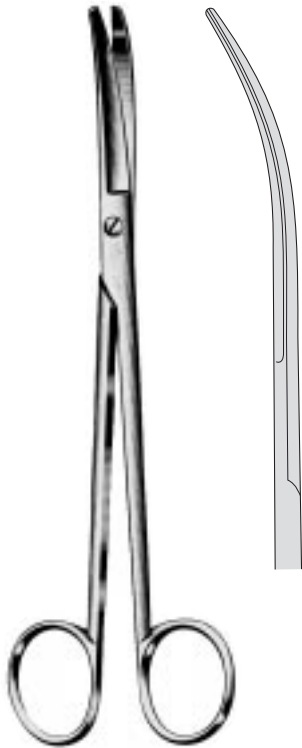

WERTHEIM

- 13.0561 14,5 cm
- 13.0562 19,5 cm
- 13.0563 22,5 cm



THOREK

- 13.0565 19 cm
- 13.0567 23 cm



LEXER-BABY

- 13.0700
10 cm

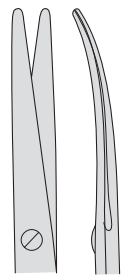

- 10.0701
10 cm

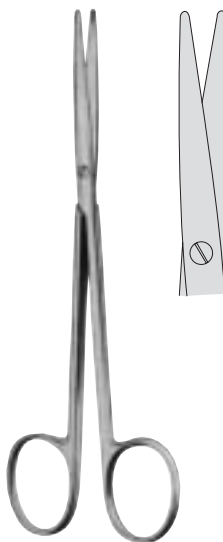

METZENBAUM-BABY

- 13.0594 11,5 cm
- 13.0594SC 11,5 cm
- 13.0596 13,0 cm
- 13.0598 14,5 cm
- 13.0598SC 14,5 cm

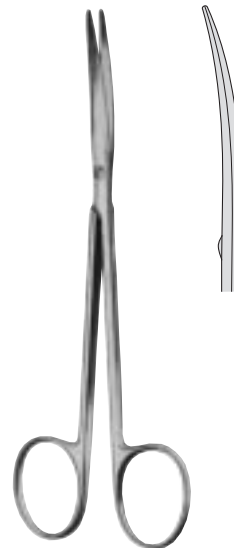

METZENBAUM-BABY

- 13.0595 11,5 cm
- 13.0595SC 11,5 cm
- 13.0597 13,0 cm
- 13.0599 14,5 cm
- 13.0599SC 14,5 cm



METZENBAUM
14,5 cm



13.0600

13.0600L

linkshändig/left-handed/
pour gaucher/para zurdo/
per mano sinistra

13.0600SC



13.0620



13.0640



13.0601

13.0601L

linkshändig/left-handed/
pour gaucher/para zurdo/
per mano sinistra

13.0601SC



13.0621

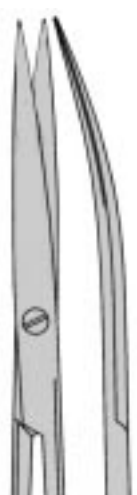

13.0641



LAHEY-METZENBAUM



13.0752
15 cm

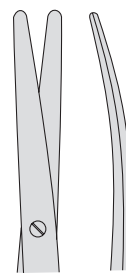

13.0753
15 cm



stumpf - stumpf
 blunt - blunt
 mousses - mousses
 romo - romo
 smusso - smusso



spitz - stumpf
 sharp - blunt
 pointu - mousses
 agudo - romo
 appuntato - smusso



METZENBAUM

13.0602	18,0 cm	13.0602SC
13.0604	20,0 cm	13.0604SC
13.0606	23,0 cm	13.0606SC
13.0608	25,0 cm	13.0608SC
13.0610	28,0 cm	13.0610SC
13.0612	30,0 cm	13.0612SC

METZENBAUM

13.0603	18,0 cm	13.0603SC
13.0605	20,0 cm	13.0605SC
13.0607	23,0 cm	13.0607SC
13.0609	25,0 cm	13.0609SC
13.0611	28,0 cm	13.0611SC
13.0613	30,0 cm	13.0613SC

METZENBAUM

13.0622	18,0 cm
13.0624	20,0 cm
13.0626	23,0 cm
13.0628	25,0 cm
13.0630	28,0 cm

METZENBAUM

13.0623	18,0 cm
13.0625	20,0 cm
13.0627	23,0 cm
13.0629	25,0 cm
13.0631	28,0 cm



spitz - spitz
 sharp - sharp
 pointu - pointu
 agudo - agudo
 appuntato - appuntato



METZENBAUM

13.0642	18,0 cm	
13.0644	20,0 cm	13.0644SC
13.0646	23,0 cm	
13.0648	25,0 cm	
13.0650	28,0 cm	13.0650SC

METZENBAUM

13.0643	18,0 cm	
13.0645	20,0 cm	13.0645SC
13.0647	23,0 cm	
13.0649	25,0 cm	
13.0651	28,0 cm	13.0651SC

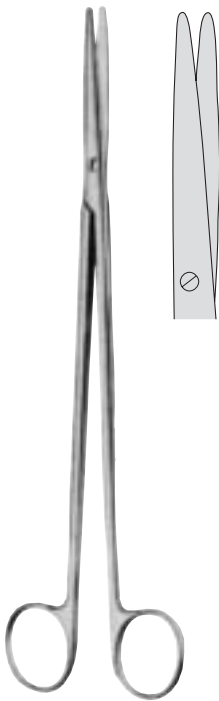

METZENBAUM-FINO

- 13.0660 14,5 cm **13.0660SC**
- 13.0662 18,0 cm **13.0662SC**
- 13.0664 20,0 cm **13.0664SC**
- 13.0666 23,0 cm **13.0666SC**

METZENBAUM-FINO

- 13.0661 14,5 cm **13.0661SC**
- 13.0663 18,0 cm **13.0663SC**
- 13.0665 20,0 cm **13.0665SC**
- 13.0667 23,0 cm **13.0667SC**

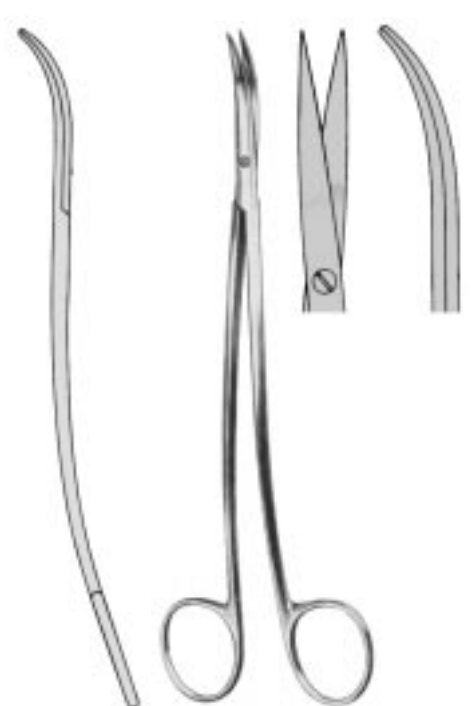
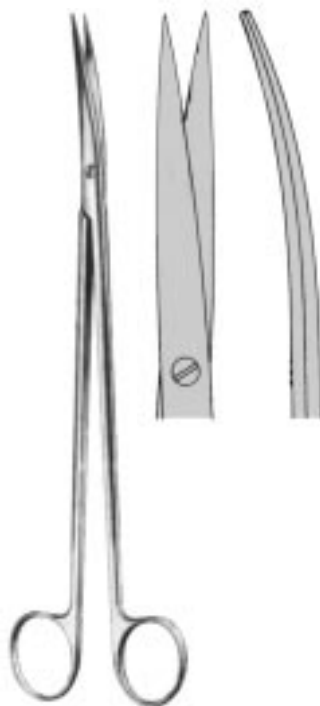

METZENBAUM-FINO

- 13.0670 14,5 cm
- 13.0672 18,0 cm
- 13.0674 20,0 cm
- 13.0676 23,0 cm

METZENBAUM-FINO

- 13.0671 14,5 cm
- 13.0673 18,0 cm
- 13.0675 20,0 cm
- 13.0677 23,0 cm

METZENBAUM-FINO

- 13.0683 18,0 cm
- 13.0685 20,0 cm
- 13.0687 23,0 cm

METZENBAUM-FINO

- 13.0693 18,0 cm
- 13.0695 20,0 cm
- 13.0697 23,0 cm

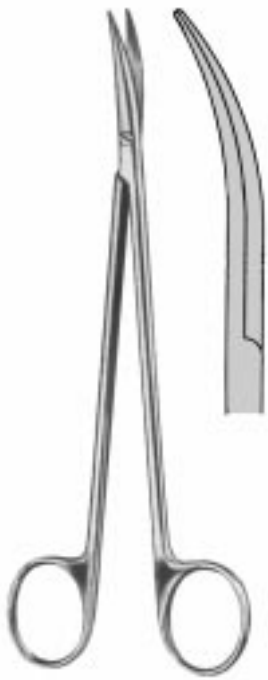

DE BAKEY
 13.0757 17 cm



TOENNIS

13.0760
 18 cm

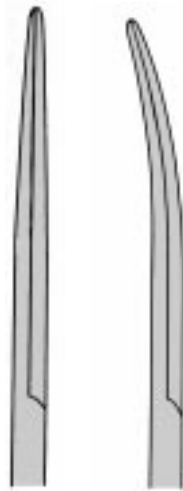

13.0761
 18 cm



TOENNIS-ADSON
 13.0765 18 cm
13.0765SC 18 cm



JAMESON-WERBER
 13.0779 13 cm



REYNOLDS



13.0770 15 cm
13.0770SC 15 cm
13.0772 18 cm

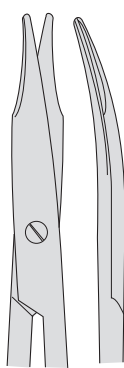

13.0771 15 cm
13.0771SC 15 cm
13.0773 18 cm
13.0775 20 cm



JAMESON
 13.0780
 15 cm
 gerade/straight/droits/recto/retto



13.0781
13.0781SC
 15 cm
 gebogen
 curved
 courbe
 curvo
 curvo



PECK-JOSEPH
14 cm

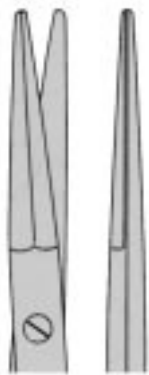

13.0790

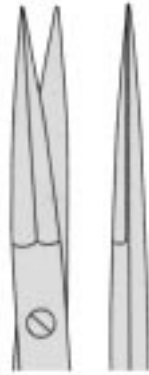

13.0792

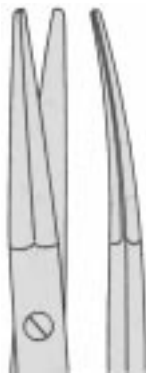

13.0791

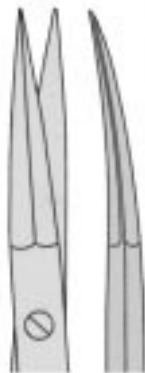

13.0793



GOLDMAN-FOX
13 cm



13.0800

13.0800SC

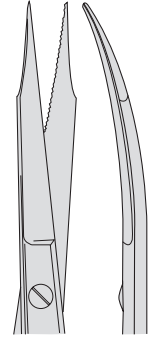

13.0801

13.0801SC



WAGNER
12 cm

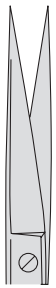

13.0820

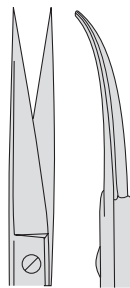

13.0821

13.0821SC

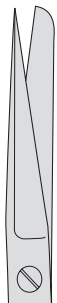

13.0822

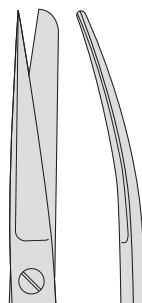

13.0823



13.0830
gezahnt
serrated
dentée
dentada
dentate

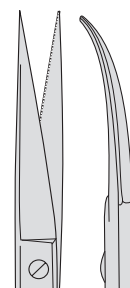

13.0831
gezahnt
serrated
dentée
dentada
dentate



13.0833



LOCKLIN
13.0840
16 cm

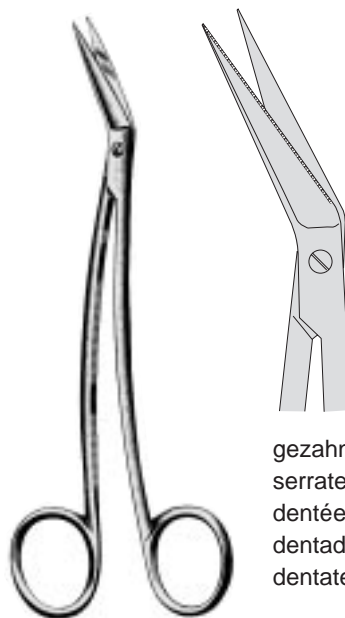

gezahnt
serrated
dentée
dentada
dentate

LOCKLIN
13.0842
16 cm



GORNEY



13.3010
12,5 cm



13.3014
19,0 cm



13.3015
19,0 cm



13.1018 9,5 cm



13.1020 11 cm



BOWMAN

13.1030 11,5 cm

geknöpft/ probe-pointed/ boutonée / botonada / bottonuta

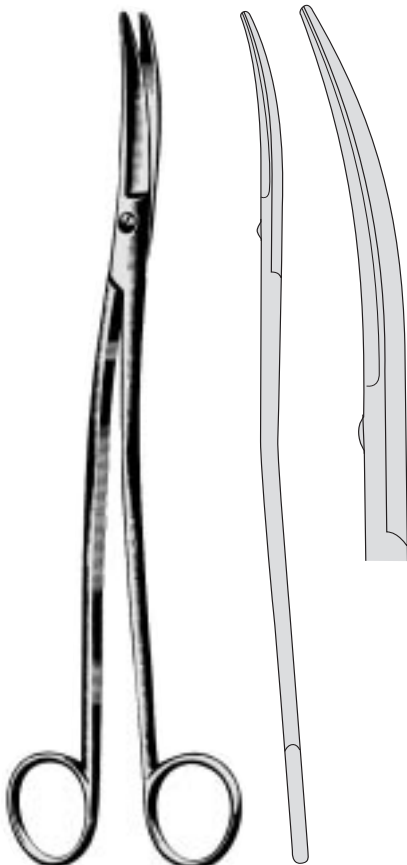

KLINGENBERG-LOTH

13.0575 23 cm

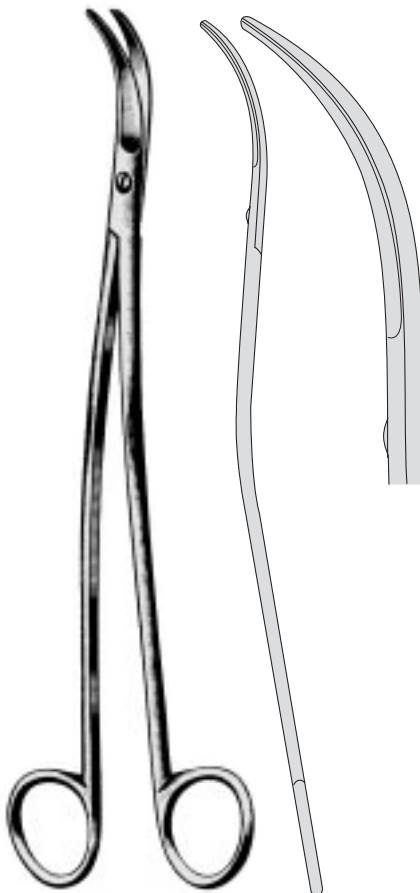

SATINSKY

13.0577 24,5 cm

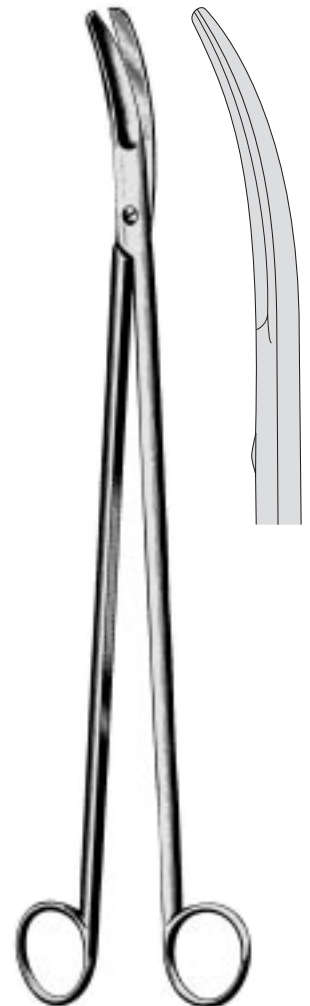

CRAFOORD

13.1081 30 cm



**HEGEMANN-
DIETRICH**

13.1090 13,5 cm /25° **13.1091** 13,5 cm /45°
13.1100 19,0 cm /25° **13.1101** 19,0 cm /45°

13.1092 13,5 cm /60° **13.1093** 13,5 cm /90°
13.1102 19,0 cm /60° **13.1103** 19,0 cm /90°

13.1094 13,5 cm /120°
13.1104 19,0 cm /120°



HEGEMANN
13.1105 19 cm 125°



ARTERIOTOMY

13.1110
 18 cm 25°

13.1111
 18 cm 45°

13.1112
 18 cm 60°

13.1113
 18 cm 90°

13.1114
 18 cm 125°

geknöpft/ probe-pointed/ boutonée / botonada / bottonuta



POTTS-SMITH

13.1130
13.1130SC
 19 cm 25°

13.1131
13.1131SC
 19 cm 45°

13.1132
13.1132SC
 19 cm 60°

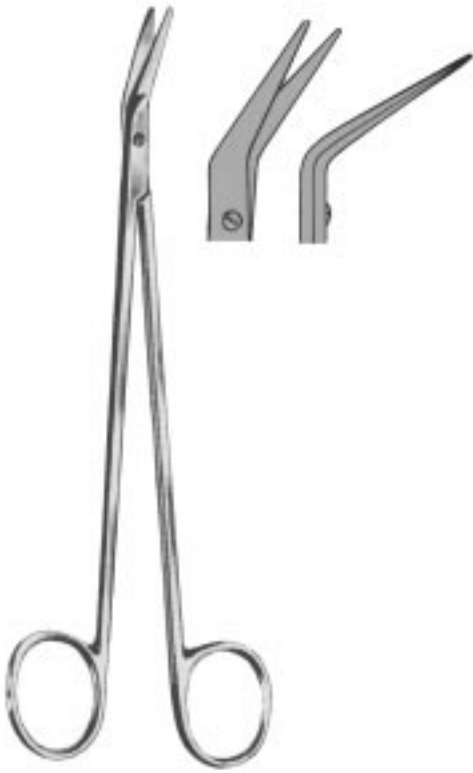

POTTS-SMITH
13.1133
 19 cm



DEBAKEY

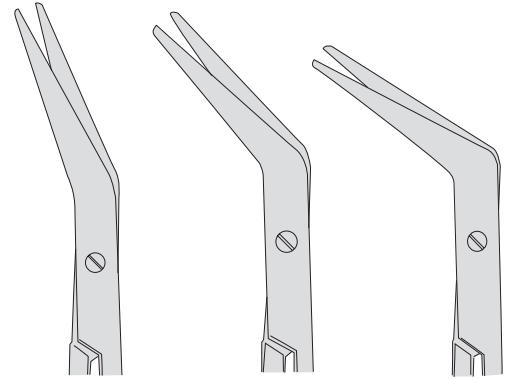

13.1150
 16 cm 25°
13.1160
 23 cm 25°

13.1151
 16 cm 45°
13.1161
 23 cm 45°

13.1152
 16 cm 60°
13.1162
 23 cm 60°

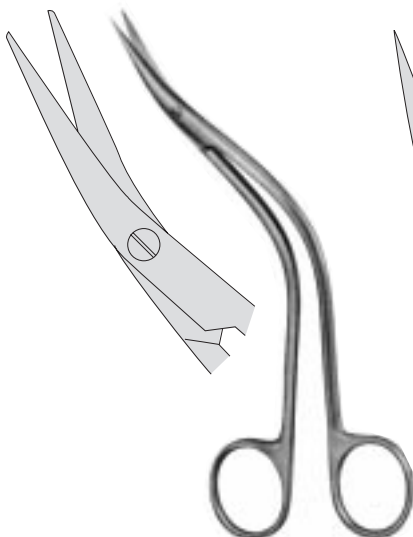

DEBAKEY
13.1165
 16 cm 25°



DEBAKEY
13.1166
 16 cm 45°



FAVOLORO
13.1170 15 cm



POTTS-DE-MARTEL

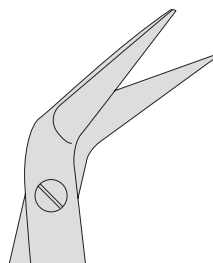

13.1180 21 cm /60°
13.1182 24 cm /60°



MILLS

13.1190 18 cm /60°
13.1192 22 cm /60°
1 Blatt geknöpft
1 probe-pointed blade
1 lame noutonée
1 hoja botonada
1 lama abbottona



SCHMIEDEN-TAYLOR
 13.2010 17 cm



DANDY
 13.2021 17 cm

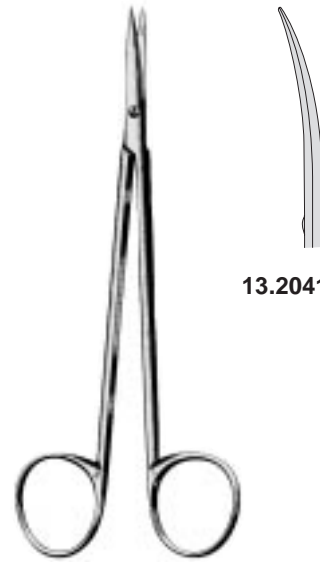

13.2041 15 cm

13.2040 15 cm
 Nerv-Präparierschere
 nerve dissecting scissors
 ciseaux à nerfs
 tijeras para nervios
 forbici per nervi trigemino, anche nasale

Trigemini-Schere, auch für Nase
 Trigeminal- and Nasal Scissors
 Ciseaux pour le nerf trigéminal et pour le nez
 Tijera para nervio trigémino y para la nariz
 forbici per nervo trigemino, anche nasale

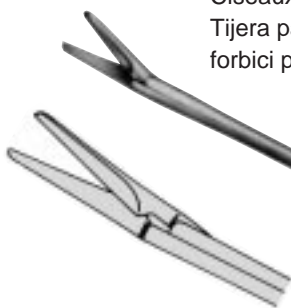

OLIVECRONA
 13.2060 23 cm



STRULLY
 13.2070 22 cm



ENTEROTOMY
13.2170 21 cm



ENTEROTOMY
13.2172 21 cm



ENTEROTOMY
13.2174 21 cm



MILLER
13.2181 17 cm



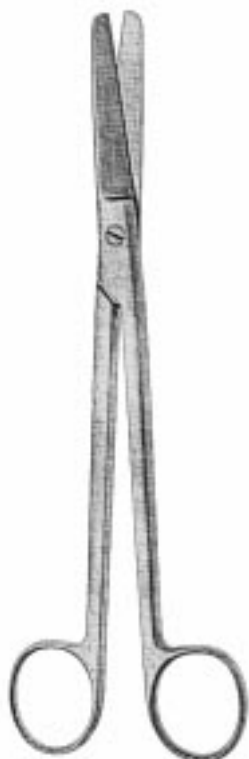

13.2101 20 cm **13.2101SC**
 13.2103 23 cm **13.2103SC**

SIMS

13.2100 20 cm **13.2100SC**
 13.2102 23 cm **13.2102SC**

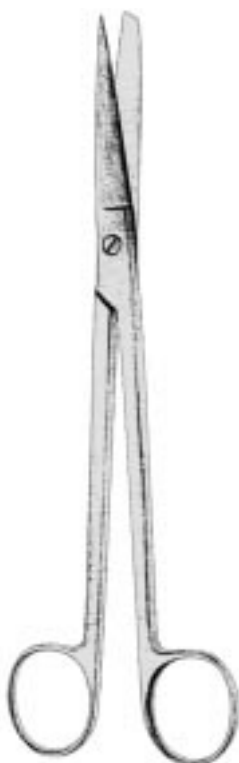

13.2111 20 cm
 13.2113 23 cm

SIMS

13.2110 20 cm
 13.2112 23 cm

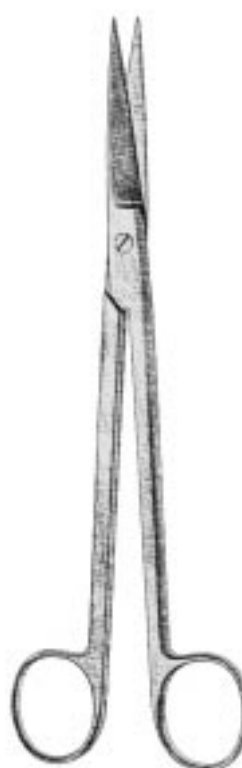

SIMS

13.2120 20 cm



13.2121 20 cm



FERGUSON
 13.2134 18 cm

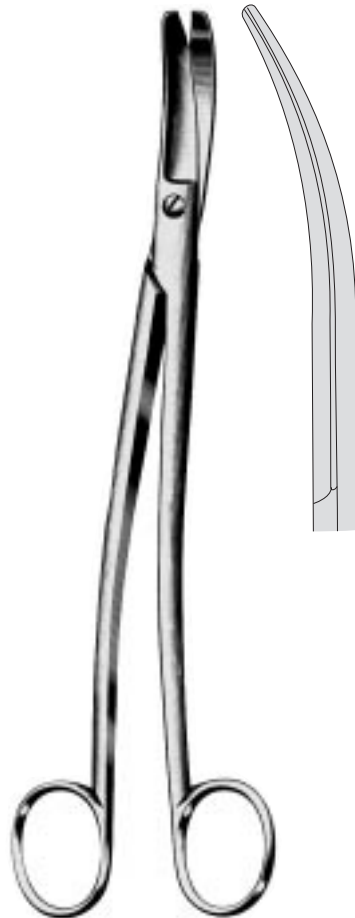

SIEBOLD
 13.2150 24 cm



BOZEMANN
 13.2155 21 cm



DOYEN
 13.2160 18 cm

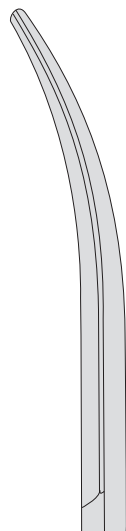

13.2161 18 cm



BRAUN-STADLER
 13.2200 14 cm
 13.2202 22 cm
 Episiotomy

Nabelschnurscheren
 Umbilical scissors
 Ciseaux pour section de
 cordon
 Tijeras umbilicales
 Forbici ombelicali



SCHUMACHER
 13.2210 15 cm

Nabelschnurscheren
 Umbilical scissors
 Ciseaux pour section de cordon
 Tijeras umbilicales
 Forbici ombelicali



SCHUMACHER
 13.2210 15 cm



UMBILICAL-USA
 13.2220 10 cm



BUSCH
 13.2232 16 cm

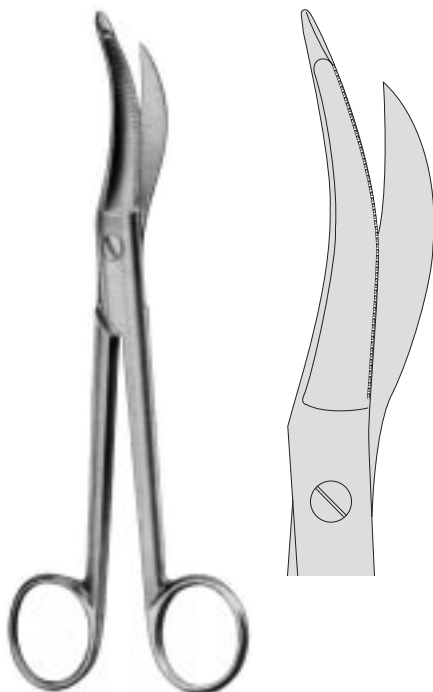

WALDMAN
 13.2240 18 cm **13.2240SC**
 13.2244 20 cm
 Episiotomy

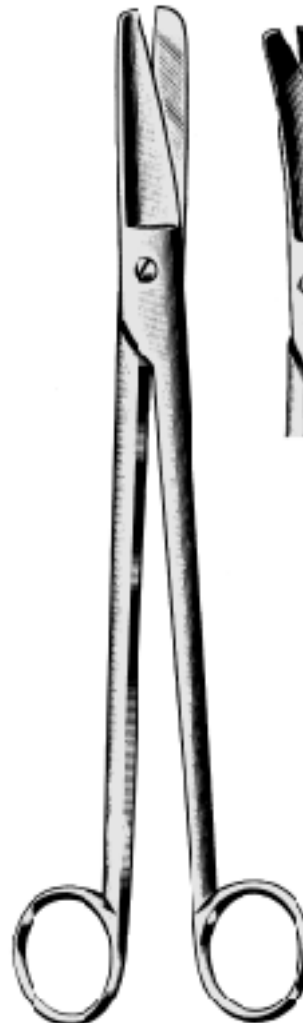

DUBOIS
 56.0600 27 cm

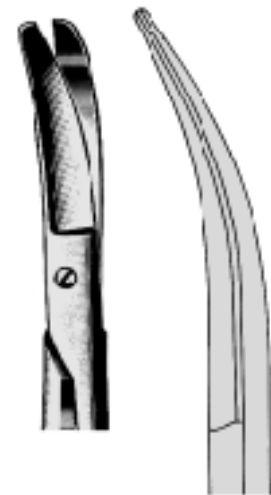

56.0601 27 cm

Kephalatomiescheren
 Decapitating scissors
 Ciseaux à détroncation
 Tijeras para decapitación
 Forbici per decapitazione



SPENCER

13.2300 9,0 cm
13.2304 10,5 cm
13.2302 13,0 cm



SPENCER

13.2301 9 cm
13.2303 13 cm



LITTAUER

13.2310 14 cm

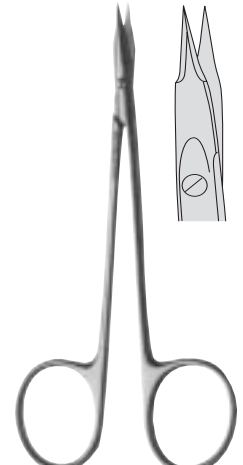

GRADLE

13.2320 9,5 cm
13.2322 12,5 cm



O'BRIEN

13.2340 9,5 cm



EISELBERG

13.2350 12 cm



SCHOEMAKER-LOTH

13.2356 13 cm

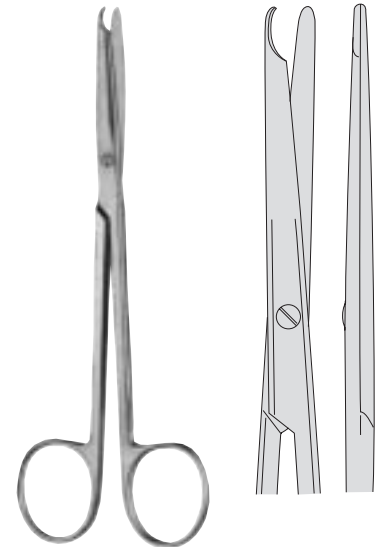

BUCK

13.2360 14,5 cm



HARVEY

13.2400 13 cm



UNIVERSAL

13.2401 12 cm

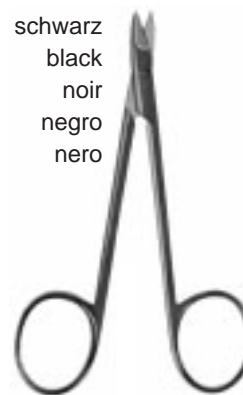

schwarz
black
noir
negro
nero

GUILFORD

13.2404 10 cm

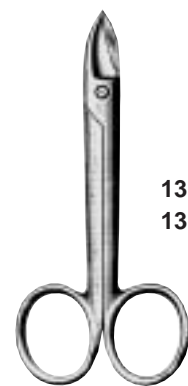

BEEBEE

13.2420 10,0 cm
13.2424 12,5 cm



13.2421 10,0 cm
13.2425 12,5 cm



HEYMANN
 13.2700 18 cm



KIRSTEIN
 13.2705 17 cm
 gezahnt
 serrated
 dentée
 dentada
 dentate



FOMON-DORSAL
 13.2726 15 cm **13.2726SC**



FOMON
 13.2740 13 cm

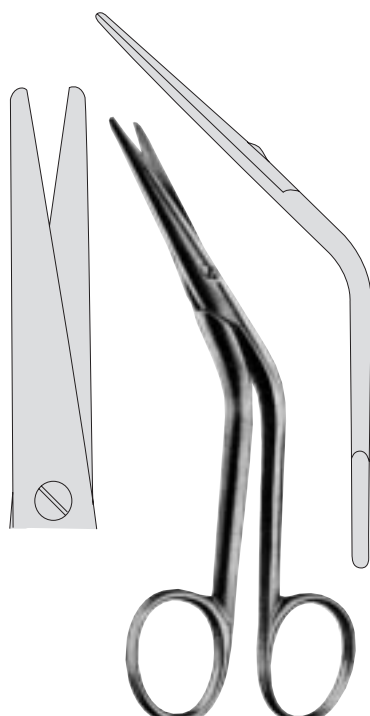

COTTLE-DORSAL
 13.2750 15 cm **13.2750SC**

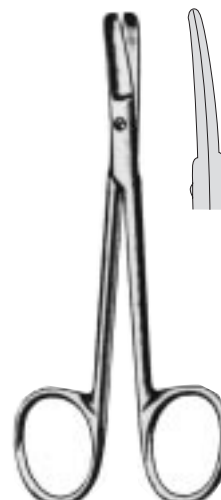

COTTLE-BULLDOG
 13.2757 11,5 cm

gezahnt / serrated / dentelées / dentada / dentate



13.2770 gerade / straight
 droit / recto / retto



13.2771 rechts gebogen / curved right
 courbe à droite / curvo por
 derecho / curvo a destra



13.2773 links gebogen / curved left
 courbe à gauche / curvo por
 izquierdo / curvo a sinistra

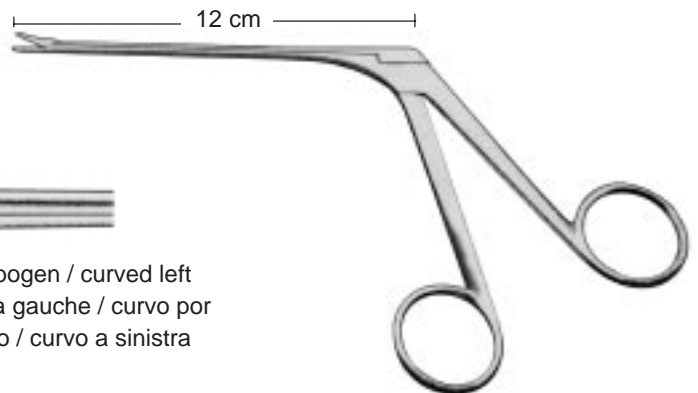

COTTLE-MASING
 10,5 cm



13.2791



13.2793

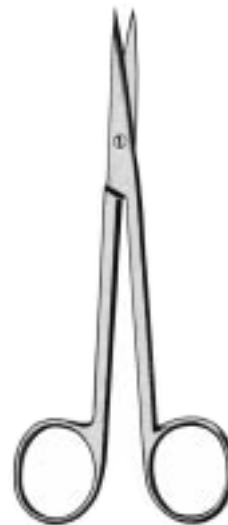

KILNER
13.2800
 12,5 cm



KILNER
13.2801
 12,5 cm

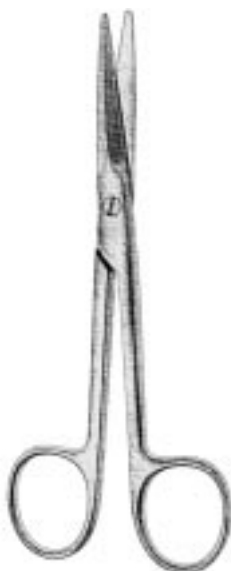

AUFRICHT
 15 cm

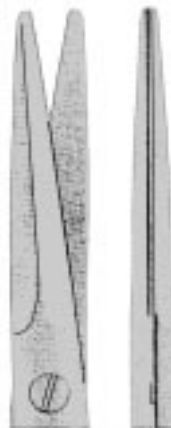

13.2810

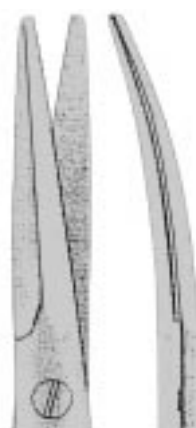

13.2811



LITTLER
13.2821 12 cm
13.2823 14 cm

gezahnt / serrated / dentée / dentada / dentate



KAYE
 13.2831 14,5 cm
 13.2835 18,0 cm



KAYE
 13.2833 14,5 cm



KAYE
 13.2845 12,0 cm



KILNER (RAGNELL)
 12 cm



13.2850
13.2850SC
 13.2850L



13.2851
13.2851SC
 13.2851L



13.2853 15 cm
 13.2855 18 cm

linkshändig/left-handed/pour gaucher/
 para zurdo/per mano sinistra



SANVENERO
 13.2858
 14 cm



SANVENERO
 13.2859
 14 cm



BROPHY
 13.2860 14 cm

13.2862 14 cm
 gezahnt / serrated /
 dentelées / dentada / dentate



BROPHY
 13.2861 14 cm

13.2863 14 cm
 gezahnt / serrated /
 dentelées / dentada / dentate



JOSEPH
 13.2866 14 cm

13.2868 14 cm
 gezahnt / serrated /
 dentelées / dentada / dentate

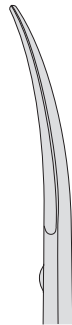

13.2867 14 cm **13.2867SC**

13.2869 14 cm
 gezahnt / serrated /
 dentelées / dentada / dentate

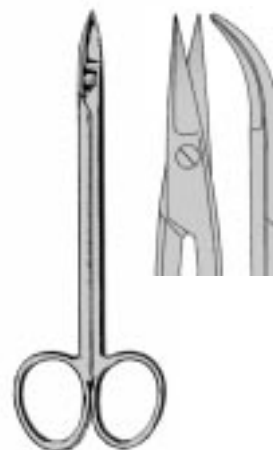

QUINBY
 13.2870 12,5 cm

gezahnt / serrated /
 dentelées / dentada / dentate

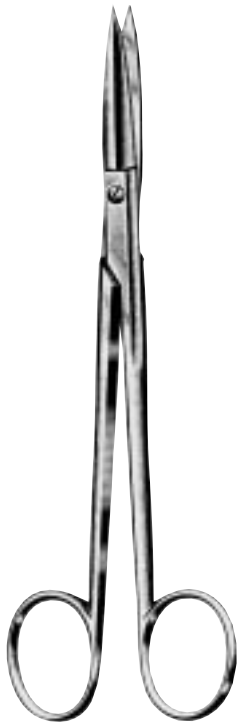

MCINDOE
 13.2890 19 cm

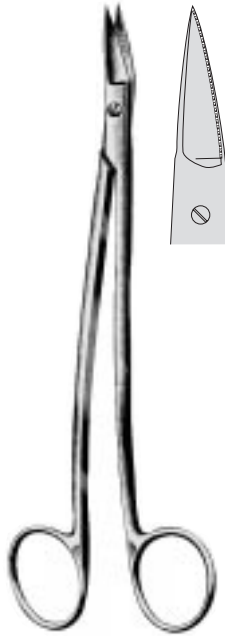

DEAN
 13.2901 17 cm
 glatt/smooth
 lisse/lisa/liscio
 13.2903 17 cm,
 gezahnt/serrated
 dentée/dentada/
 dentate

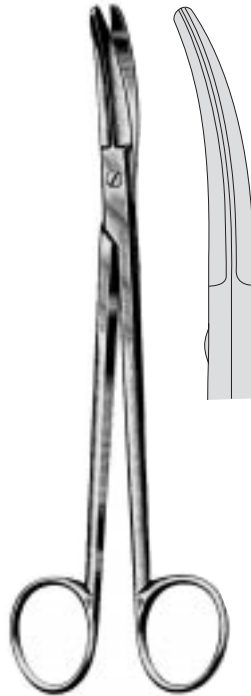

BOETTCHER
 13.2925 18 cm

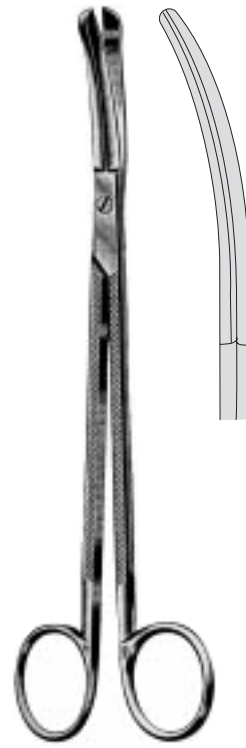

GOOD
 13.2930 19 cm
 glatt/smooth
 lisse/lisa/liscio
 13.2932 19 cm,
 gezahnt/serrated
 dentée/dentada/
 dentate

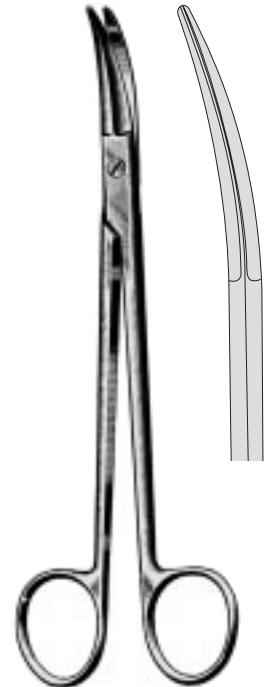

PRINCE
 13.2941 17 cm



CAPLAN
 33.0222
 22 cm

Septumscheren
 Septum Scissors
 Ciseaux par la cloison nasale
 Tijeras para el tabique nasal
 Forbici per il setto nasale



GORNEY (KILLIAN)
 33.0250
 21 cm

Kropfschere/Goitre Scissors/
Ciseaux à goitre/Tijeras para bocio/
Forbice per gozzo



SCHOEMAKER
36.0400
15 cm

Speichelgangschere/Salivary Gland Scissors/
Ciseaux pour voie salivaire/
Tijeras para el canal salivar/
Forbice per condotto saliva



PERWITZSCHKY
33.2901
11,5 cm

Knorpelscheren
Cartilage Scissors
Ciseaux pour le cartilage
Tijeras para cartilago
Forbici per cartilagini



MARTIN
23.3320
20 cm

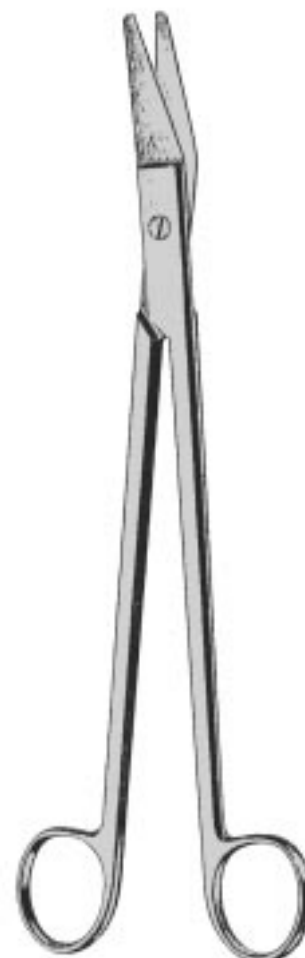

RESANO
23.3325
25 cm



IRIS
13.5000
11,5 cm

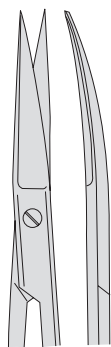

IRIS
13.5001
11,5 cm



IRIS
13.5007
11,5 cm



STRABISMUS
13.5010
11,5 cm



STRABISMUS
13.5011
11,5 cm



GOLDMAN-FOX
13.5020
13 cm

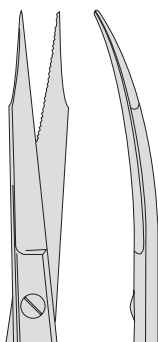

GOLDMAN-FOX
13.5021
13 cm



BABY-LEXER
13.5030
10 cm

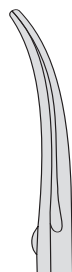

BABY-LEXER
13.5031
10 cm



RAGNELL
13.5041
11,5 cm



STANDARD

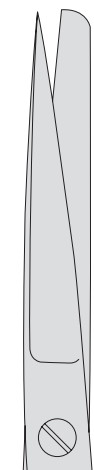

13.5100
14,5 cm
13.5102
16,5 cm

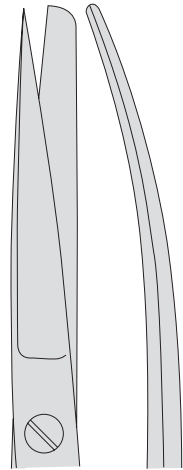

13.5101
14,5 cm
13.5103
16,5 cm

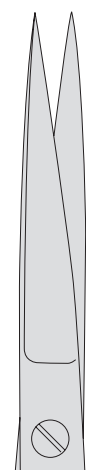

13.5110
14,5 cm

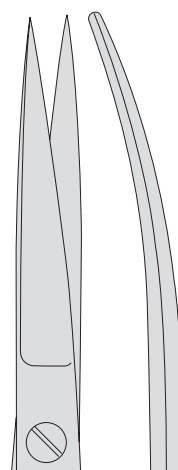

13.5111
14,5 cm



13.5120
14,5 cm

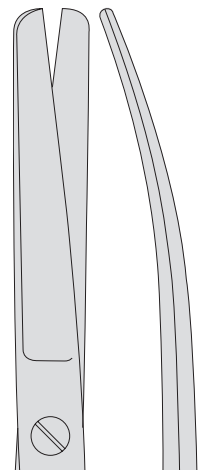

13.5121
14,5 cm



MAYO

13.5200 14,5 cm
13.5202 17 cm
13.5204 23 cm



MAYO

13.5201 14,5 cm
13.5203 17 cm
13.5205 23 cm



MAYO-STILLE

13.5210 15 cm
13.5212 17 cm

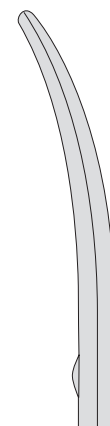

MAYO-STILLE

13.5211 15 cm
13.5213 17 cm

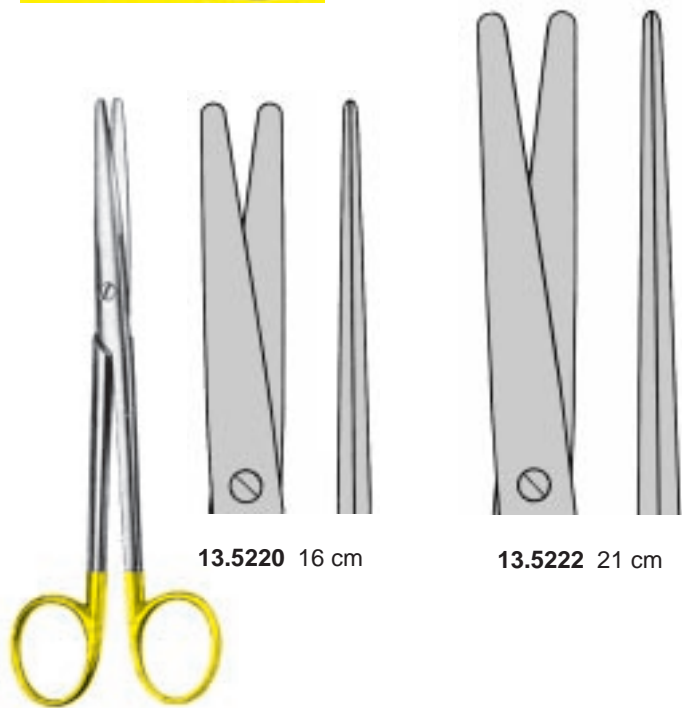

13.5220 16 cm

13.5222 21 cm

MAYO-LEXER

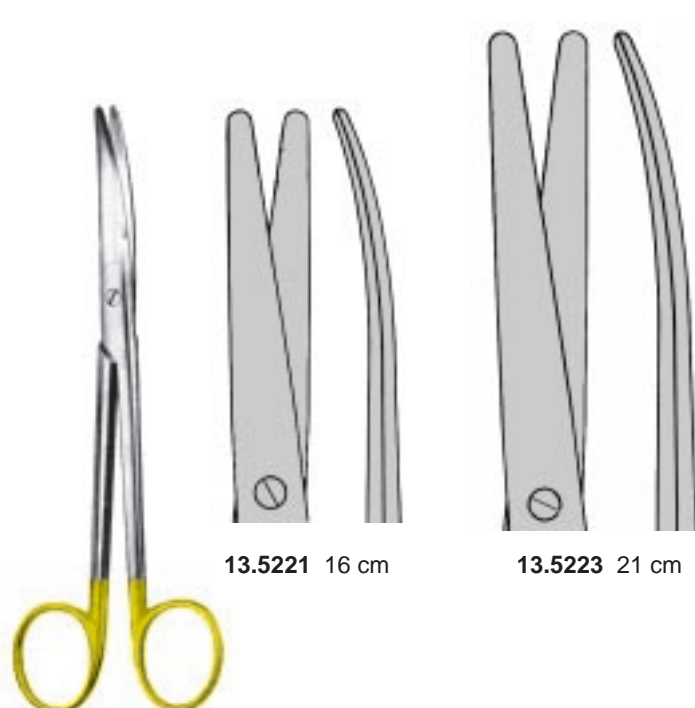

13.5221 16 cm

13.5223 21 cm

MAYO-LEXER



MAYO-HARRINGTON
 13.5241 23 cm
 13.5243 28 cm

MAYO-HARRINGTON

13.5240 23 cm
 13.5242 28 cm



SIMS
 13.5249 20 cm
 13.5251 23 cm

SIMS

13.5248 20 cm
 13.5250 23 cm



PARAMETRIUM
23 cm



13.5255



13.5259



BLESSING
13.5281
30 cm

Schere für Rektumchirurgie
Scissors for rectal surgery
Ciseaux pour chirurgie rectale
Tijera para la cirugía del recto
Forbici per la chirurgia rettale

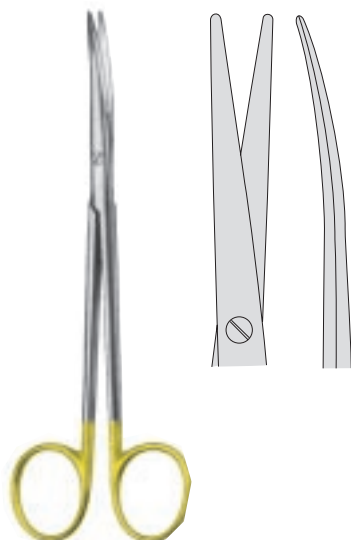

TOENNIS-ADSON
13.5291 17,5 cm



METZENBAUM

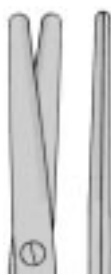

13.5298
11,5 cm

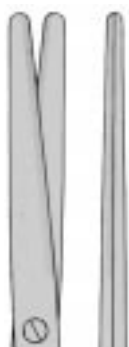

13.5300
14,5 cm



METZENBAUM



13.5299
11,5 cm



13.5301
14,5 cm



METZENBAUM

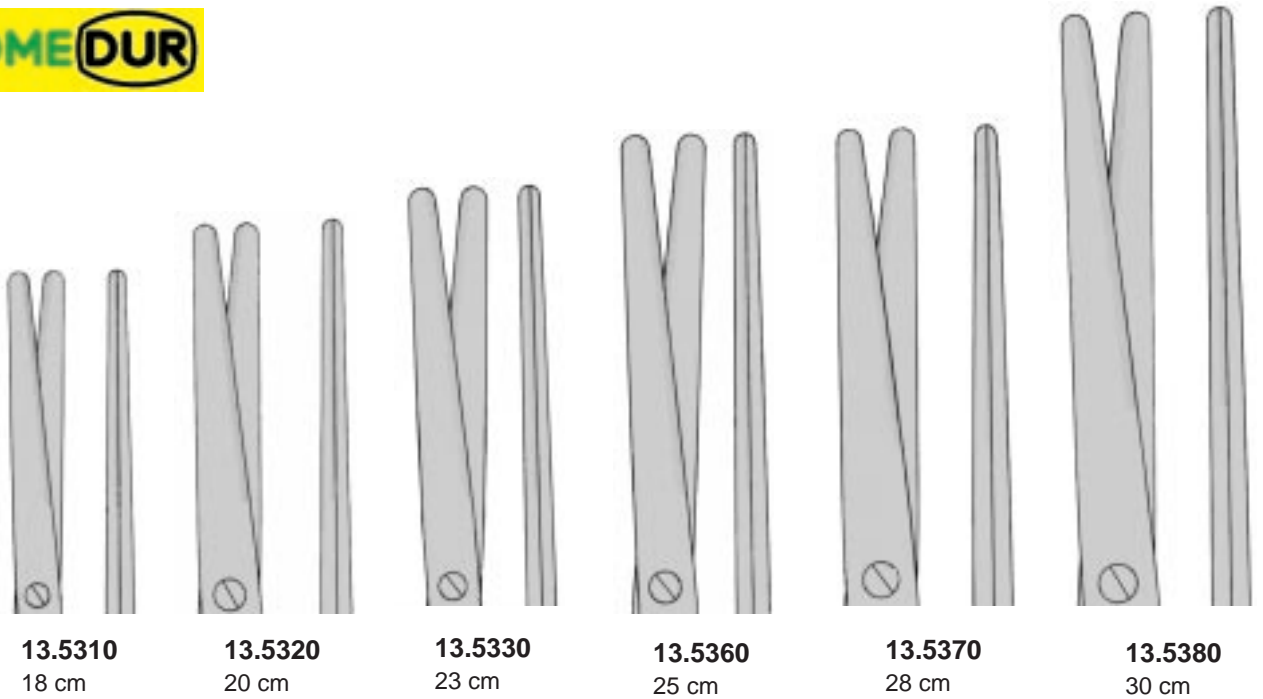

METZENBAUM

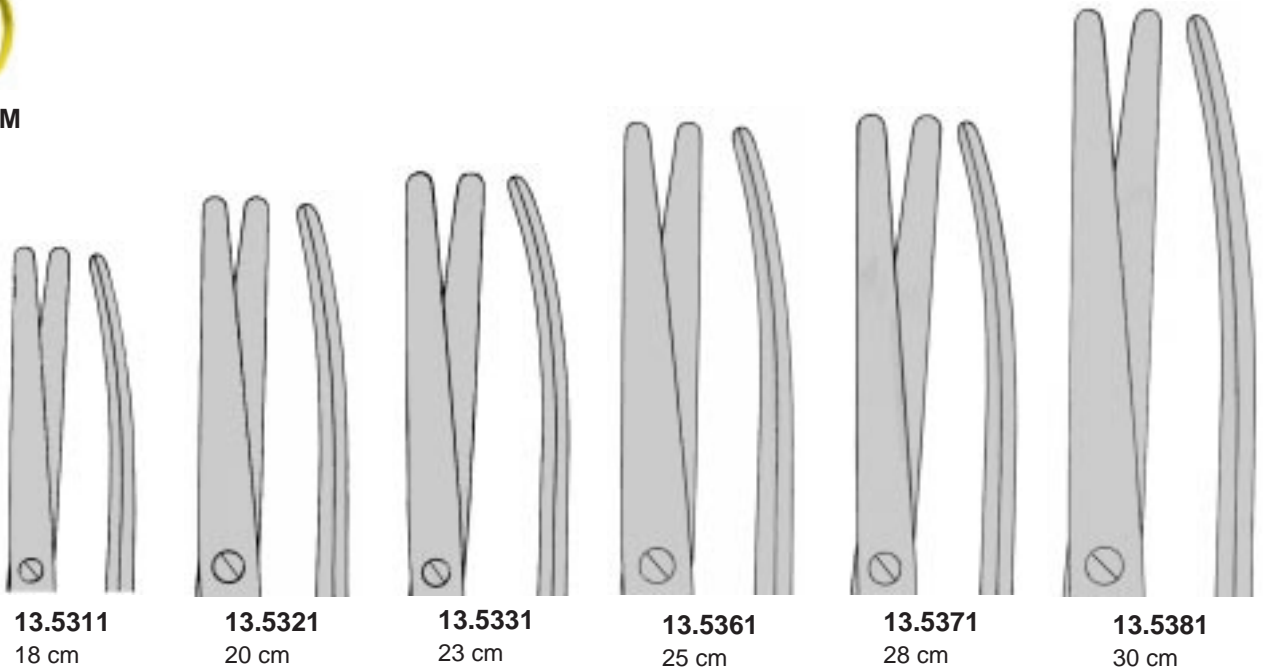



METZENBAUM-FINO

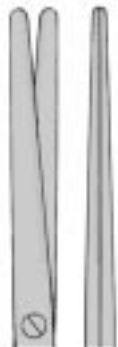

13.5304
14,5 cm

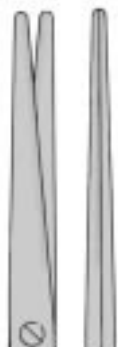

13.5314
18 cm



13.5324
20 cm

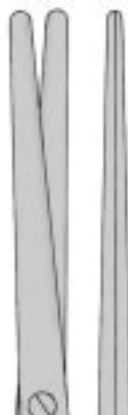

13.5334
23 cm



13.5364
25 cm



13.5374
28 cm



METZENBAUM-FINO



13.5305
14,5 cm



13.5315
18 cm



13.5325
20 cm



13.5335
23 cm



13.5365
25 cm

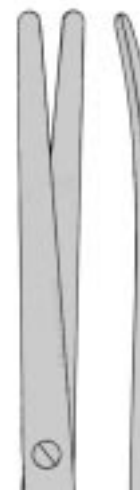

13.5375
28 cm

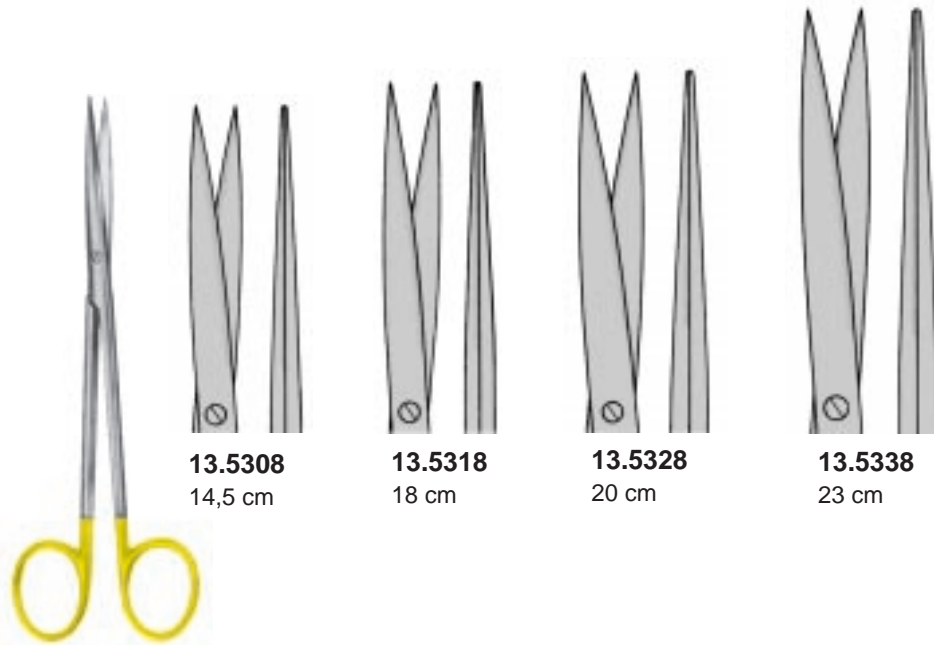

13.5308
14,5 cm

13.5318
18 cm

13.5328
20 cm

13.5338
23 cm

METZENBAUM X-FINO

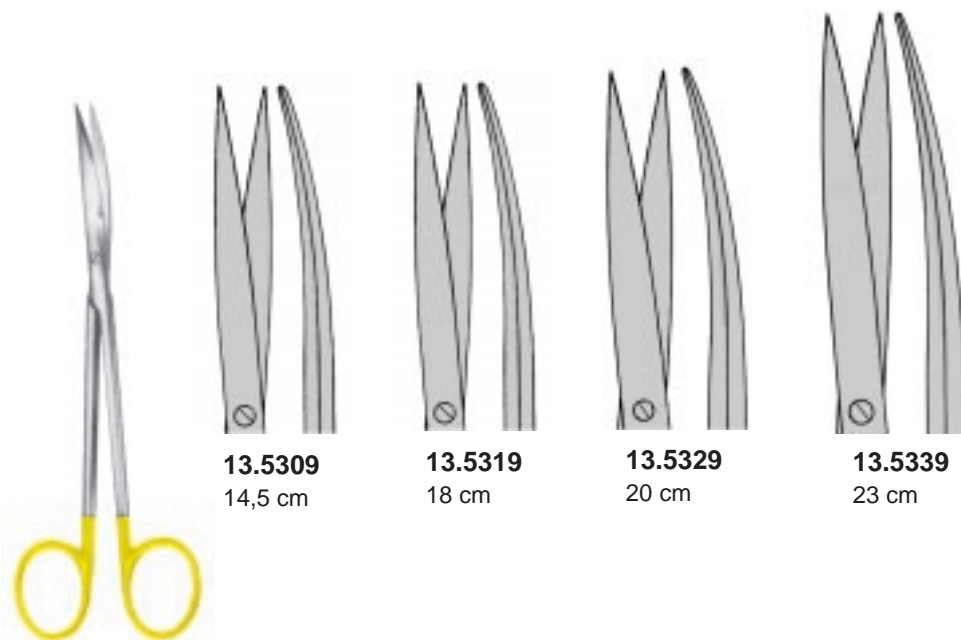

13.5309
14,5 cm

13.5319
18 cm

13.5329
20 cm

13.5339
23 cm

METZENBAUM X-FINO



METZENBAUM-FINO

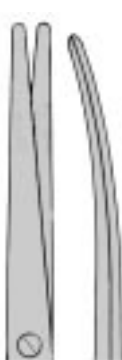

13.5313
18 cm



13.5323
20 cm



13.5333
23 cm



METZENBAUM-FINO



13.5317
18 cm



13.5327
20 cm



13.5337
23 cm



POTTS-SMITH

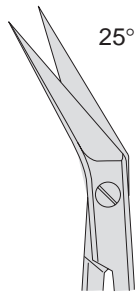

POTTS-SMITH
 13.5600 19 cm

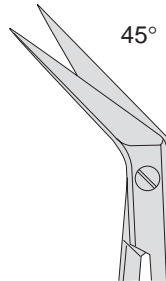

POTTS-SMITH
 13.5601 19 cm

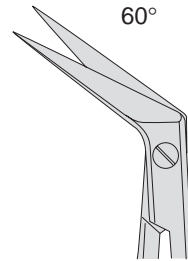

POTTS-SMITH
 13.5602 19 cm



DEBAKEY

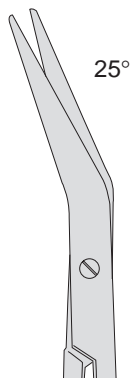

DEBAKEY
 13.5610 19 cm
 13.5620 23 cm
 13.5630 28 cm

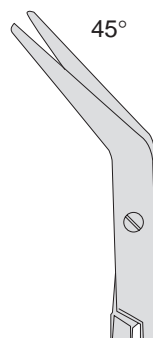

DEBAKEY
 13.5611 19 cm
 13.5621 23 cm
 13.5631 28 cm

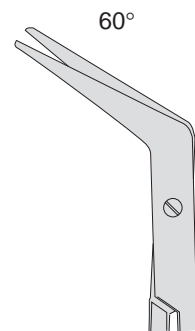

DEBAKEY
 13.5612 19 cm
 13.5622 23 cm
 13.5632 28 cm



13.5800

13.5801

KELLY
16 cm



gezahnt
serrated
dentelée
dentada
dentate

LOCKLIN
13.5813
16 cm

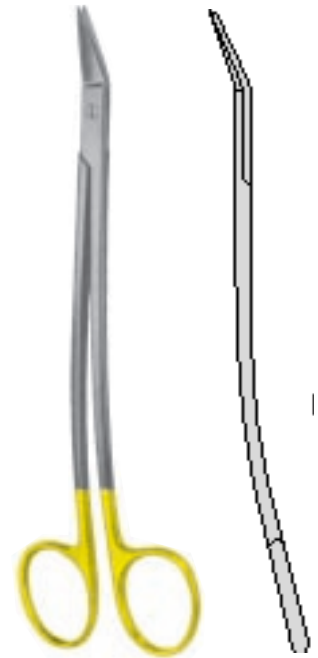

DEAN
13.5901 17 cm
glatt / smooth / lisse / lisa / liscio
13.5903 17 cm
gezahnt / serrated / dentelée
dentada / dentate



gezahnt
serrated
dentelée
dentada
dentate

LIGATUR
13.2393W 14,5 cm
13.2394W 18,0 cm
13.2395W 20,0 cm
13.2396W 23,0 cm
13.2397W 25,0 cm

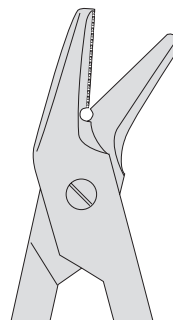

UNIVERSAL
13.5401
12,5 cm



SMITH
13.5410
16 cm



LISTER

- 21.0200 9,0 cm
- 21.0202 11,5 cm
- 21.0204 14,0 cm
- 21.0205 15,5 cm
- 21.0206 18,0 cm
- 21.0208 20,0 cm

21.0206L 18,0 cm
 linkshändig/left-handed/
 pour gaucher/para zurdo/
 per mano sinistra



LISTER-EXCENTRIC

- 21.0210 16 cm
- 21.0212 19 cm

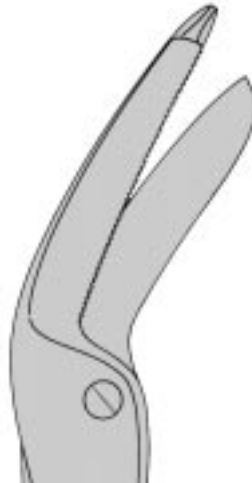

LISTER

- 21.0216 18 cm

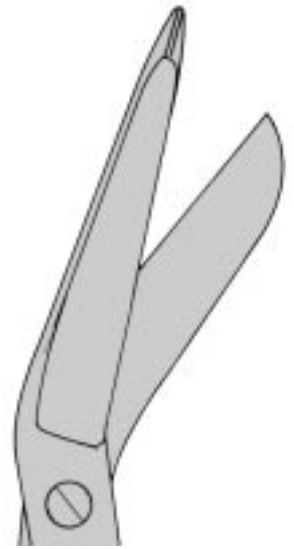

LISTER

- 21.0226 18 cm
- 21.0228 21 cm



KNOWLES

- 21.0230 14 cm



LORENZ

- 21.0241 23 cm





ESMARCH
21.0250 20 cm
21.0252 22 cm



BERGMANN
21.0260 23 cm



SMITH
21.0270 18 cm
21.0272 20 cm
21.0274 23 cm



UNIVERSAL
21.0280 15 cm



UNIVERSAL
21.0300 18 cm



UNIVERSAL
21.0310 15 cm



STILLE
21.0500 24 cm



STILLE
21.0510 23 cm
21.0512 26 cm
21.0514 37 cm



BRUNS
21.0540 23 cm
glatt/smooth
lisse/lisa/liscio
21.0545 23 cm
gezahnt/serrated
dentelée/dentadas/
dentate



BRUNS
21.0550 23 cm



WALTON
21.0560 20 cm



SEUTIN
21.0580 23 cm

PINZETTEN
FORCEPS
PINCES
PINZAS
PINZE

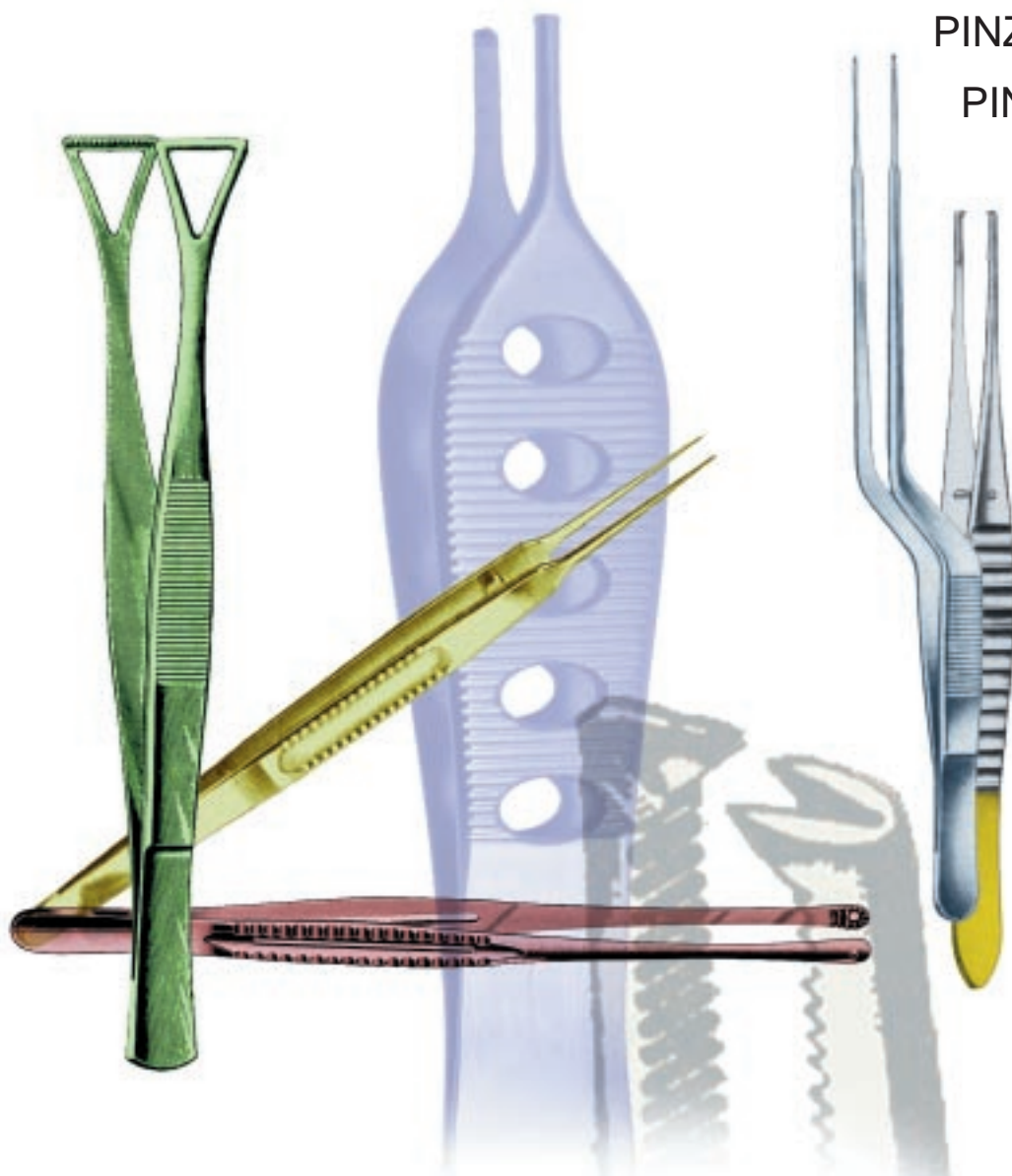

TITANIUM



GRAEFE
14.0010 10 cm



GRAEFE
14.0011 10 cm



GRAEFE
14.0013 10 cm



GRAEFE-SELECT
10 cm



30.2000
0,8 mm



30.2001
0,8 mm



30.2003
0,8 mm



30.2009
0,8 mm



30.2000 T
0,8 mm



30.2001T
0,8 mm



30.2003T
0,8 mm

TITANIUM



GRAEFE-SELECT
10 cm



30.2004
0,5 mm



30.2005
0,5 mm



30.2007
0,5 mm

Uhrmacher-Pinzetten / Jeweller Type Forceps / Pincés d'horloger
 /Pinzas de relojero / Pinze de orologiaio



JUWELIER #1
 14.1600 11,5 cm



JUWELIER #3
 14.1602 11,5 cm



JUWELIER #3C
 14.1603 10,5 cm



JUWELIER #4
 14.1604 11 cm



JUWELIER #5
 14.1605 11 cm



JUWELIER #7
 14.1607 11,5 cm



MIKRO
 15.5 cm



14.0380
 0,6 mm



14.0382
 0,8 mm



14.0384
 1,0 mm



PRO-MED Select
 14.1614 11 cm



PRO-MED Select
 14.1617 11.5 cm

TITANIUM



ADSON
 14.0026 12 cm



ADSON-MICRO
 14.0028 12 cm



ADSON-MICRO
 14.0030 12 cm
 14.0032 15 cm



ADSON
 14.0040 12 cm
 14.0040T 12 cm
 14.0042 15 cm
 14.0042T 15 cm



12 cm

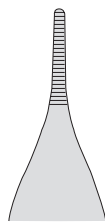

EWALD
 14.0049

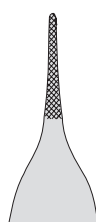

ADSON
 "Criss-Cross"
 14.0050



ADSON-DEBAKEY
 14.0546 12,5 cm
 14.0547 15,0 cm

TITANIUM



ADSON
 14.0044 18 cm



JEFFERSON
 14.0056 18 cm



SEMKEN



14.0060 12 cm
 14.0060T 12 cm
 14.0062 15 cm



14.0061
 14.0063



McINDOE



14.0070 15 cm
 14.0070T 15 cm

TITANIUM



DRESSING-FINO

- 14.0100 10,5 cm
- 14.0101 11,5 cm
- 14.0102 13,0 cm
- 14.0103 14,5 cm
- 14.0104 15,0 cm
- 14.0105 16,0 cm
- 14.0107 18,0 cm
- 14.0108 20,0 cm
- 14.0108T 20,0 cm**
- 14.0109 25,0 cm



DRESSING-FINO

- 14.0110 10,5 cm
- 14.0111 11,5 cm
- 14.0112 13,0 cm
- 14.0113 14,5 cm
- 14.0114 15,0 cm
- 14.0115 16,0 cm
- 14.0116 18,0 cm
- 14.0117 20,0 cm
- 14.0118 25,0 cm
- 14.0119 30,0 cm



DRESSING

- 14.0120 10,5 cm
- 14.0121 11,5 cm
- 14.0122 13,0 cm
- 14.0123 14,5 cm
- 14.0123T 14,5 cm**
- 14.0124 15,0 cm
- 14.0125 16,0 cm
- 14.0127 18,0 cm
- 14.0128 20 cm
- 14.0128T 20,0 cm**
- 14.0129 25,0 cm
- 14.0130 30,0 cm



DRESSING

- 14.0151 11,5 cm
- 14.0152 13,0 cm
- 14.0153 14,5 cm
- 14.0154 15,0 cm
- 14.0155 16,0 cm
- 14.0157 18,0 cm
- 14.0158 20,0 cm



DRESSING-USA

- 14.0181 11,5 cm
- 14.0182 13,0 cm
- 14.0183 14,5 cm
- 14.0184 15,5 cm
- 14.0187 18,0 cm
- 14.0188 20,0 cm
- 14.0189 25,0 cm



STILLE

- 14.0202 13 cm
- 14.0204 15 cm
- 14.0207 17 cm
- 14.0220 20 cm



BLANK

- 14.0142 13,0 cm
- 14.0143 14,5 cm
- 14.0144 16,0 cm



BROPHY
14.0300 20 cm



BROPHY
14.0301 20 cm

TITANIUM



CUSHING
14.0310 18 cm



CUSHING
14.0311 18 cm



GERALD
14.0320 18 cm
14.0320T 18 cm



GERALD
14.0321 18 cm



GERALD
14.0325 18 cm

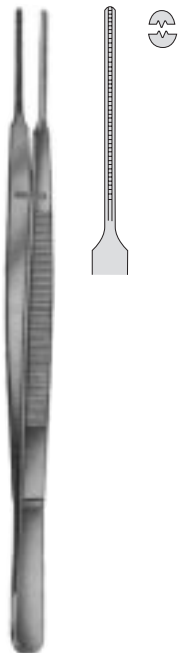

DEBAKEY-GERALD
14.0328 18 cm



DUEHRSEN
14.0330 20 cm



RAMSEY
14.0340 18 cm

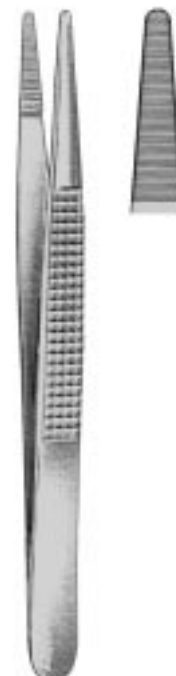

BONNEY
14.0390 18 cm



POTTS-SMITH
14.0350 18 cm
14.0350T 18 cm
14.0352 21 cm
14.0352T 21 cm
14.0354 25 cm
14.0354T 25 cm

TITANIUM

glatt / smooth / lisse / lisa / liscio



POTTS-SMITH
 14.0351 18 cm
 14.0353 21 cm



POTTS-SMITH
 14.0356 18 cm
 14.0358 21 cm



TAYLOR
 14.0360 18 cm
 14.0360T 18 cm



14.0361 18 cm
 14.0361T 18 cm



14.0366 18 cm

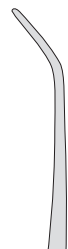

14.0367 18 cm



TAYLOR-CUSHING
 14.0362 18 cm



TAYLOR-CUSHING
 14.0365 18 cm



WAUGH
 14.0368 15 cm
 14.0370 20 cm



GRAEFE
14.0510
 10 cm 1x2



14.0511
 10 cm 1x2



14.0513
 10 cm 1x2



GRAEFE-SELECT
 10 cm



30.2010
 0,8 mm
 1x2



30.2011
 0,8 mm
 1x2



30.2013
 0,8 mm
 1x2



GRAEFE-SELECT
 10 cm



30.2014
 0,5 mm
 1x2



30.2015
 0,5 mm
 1x2



30.2017
 0,5 mm
 1x2



MIKRO
 15.5 cm



14.0780
 0,6 mm



14.0782
 0,8 mm



14.0784
 1,0 mm

TITANIUM



ADSON
 14.0526
 12 cm 1x2



ADSON-SELECT-MICRO
 14.0527
 12 cm 1x2



ADSON-MICRO
 14.0528
 12 cm 1x2



ADSON-MICRO
 14.0530 12 cm
 14.0532 15 cm



ADSON
 14.0540 12 cm
 14.0540T 12 cm
 14.0542 15 cm



ADSON
 14.0541 12 cm 2x3

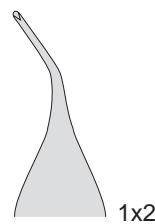

ADSON
 14.0543 12 cm 45° 1x2
 14.0545 15 cm 45° 1x2



EWALD
 14.0549 12 cm

TITANIUM



ADSON-GRAEFE
 14.0548 12 cm

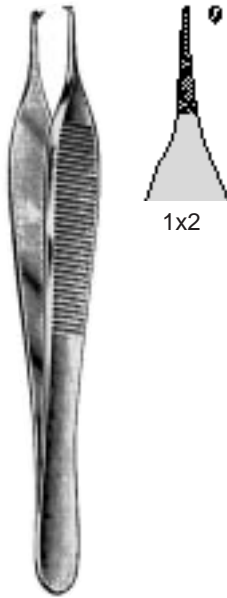

ADSON
 "Criss-Cross"
 14.0550 12 cm



ADSON
 14.0554 18 cm



JEFFERSON
 14.0556 18 cm



SEMKEN
 14.0560 12 cm
 14.0562 15 cm

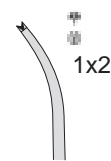

SEMKEN
 14.0561 12 cm
 14.0563 15 cm

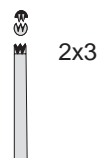

SEMKEN
 14.0566 12 cm



GILLIES
 14.0570 15 cm
 14.0570T 15 cm



- TISSUE-FINO**
- 14.0600 10,5 cm 1x2
 - 14.0601 11,5 cm 1x2
 - 14.0602 13,0 cm 1x2
 - 14.0603 14,5 cm 1x2
 - 14.0604 15,0 cm 1x2
 - 14.0605 16,0 cm 1x2
 - 14.0607 18,0 cm 1x2
 - 14.0608 20,0 cm 1x2
 - 14.0609 25,0 cm 1x2



- TISSUE**
- 14.0620 10,5 cm 1x2
 - 14.0621 11,5 cm 1x2
 - 14.0622 13,0 cm 1x2
 - 14.0623 14,5 cm 1x2
 - 14.0624 15,0 cm 1x2
 - 14.0625 16,0 cm 1x2
 - 14.0627 18,0 cm 1x2
 - 14.0628 20,0 cm 1x2
 - 14.0629 25,0 cm 1x2
 - 14.0630 30,0 cm 1x2



- TISSUE**
- 14.0653 14,0 cm 1x2
 - 14.0657 18,0 cm 1x2



- TISSUE-USA**
- 14.0681 12,0 cm 1x2
 - 14.0682 13,0 cm 1x2
 - 14.0683 14,5 cm 1x2
 - 14.0684 15,5 cm 1x2
 - 14.0687 18,0 cm 1x2
 - 14.0688 21,0 cm 1x2
 - 14.0689 25,0 cm 1x2



- TISSUE**
- 14.0701 11,5 cm 2x3
 - 14.0702 13,0 cm 2x3
 - 14.0703 14,5 cm 2x3
 - 14.0704 15,0 cm 2x3
 - 14.0705 16,0 cm 2x3
 - 14.0707 18,0 cm 2x3
 - 14.0708 20,0 cm 2x3
 - 14.0709 25,0 cm 2x3



- TISSUE**
- 14.0722 13,0 cm 3x4
 - 14.0723 14,5 cm 3x4
 - 14.0724 15,0 cm 3x4
 - 14.0725 16,0 cm 3x4
 - 14.0727 18,0 cm 3x4
 - 14.0728 20,0 cm 3x4

TITANIUM



TISSUE

14.0732 13,0 cm 4x5
14.0733 14,5 cm 4x5
14.0734 15,0 cm 4x5
14.0735 16,0 cm 4x5



FERRIS-SMITH

14.0790 18 cm 1x2



FERRIS-SMITH

14.0792 18 cm 2x3



BROPHY

14.0800 20 cm 1x2



BROPHY

14.0801 20 cm 1x2



GERALD

14.0820 18 cm 1x2

14.0820T 18 cm 1x2



GERALD

14.0821 18 cm 1x2



GERALD

14.0825 18 cm 1x2



DUEHRSEN
 14.0830 20 cm 1x2

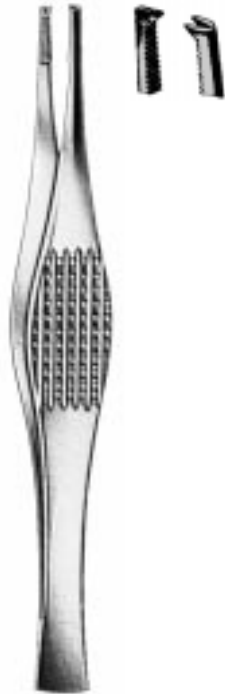

RAMSEY
 14.0840 18 cm 1x2

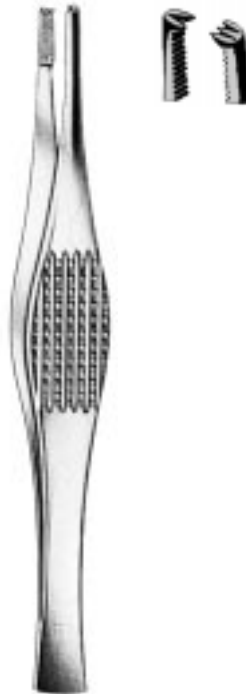

RAMSEY
 14.0842 18 cm 2x3



POTTS-SMITH
 14.0850 18 cm 1x2
 14.0852 21 cm 1x2
 14.0854 25 cm 1x2

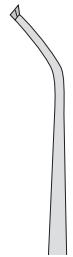

POTTS-SMITH
 14.0851 18 cm 1x2
 14.0853 21 cm 1x2
 14.0855 25 cm 1x2



TAYLOR
 14.0860 18 cm



TAYLOR
 14.0861 18 cm



TAYLOR-CUSHING
 14.0862 18 cm



TAYLOR-CUSHING
 14.0865 18 cm

TITANIUM



ALDERKREUZ
14.0866 15 cm 2x3
14.0867 20 cm 2x3



ALDERKREUZ
14.0868 15 cm 4x5
14.0869 20 cm 4x5



TREVES
14.0870 13 cm 1x2
14.0872 15 cm 1x2

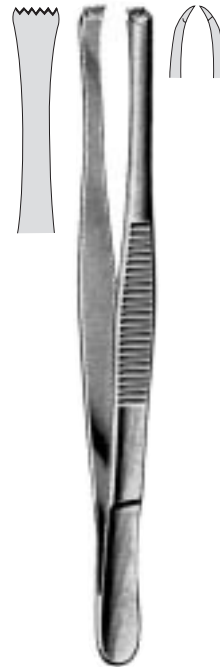

LERCHE
14.0880 15 cm 5x6

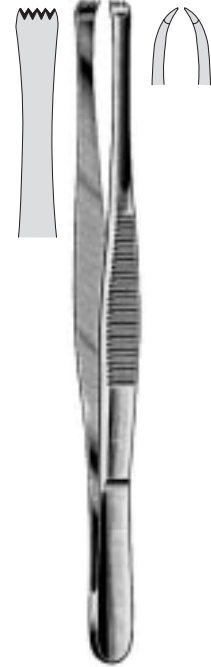

STONE
14.0885 15 cm 4x5



BONNEY
14.0890
18 cm 1x2

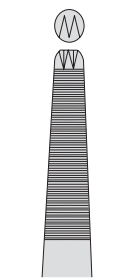

BONNEY
14.0892
18 cm 2x3



NELSON
14.0895 15 cm
14.0896 20 cm
14.0897 23 cm



ADSON-BROWN
14.0900 12 cm 9x9
14.0900T 12 cm 9x9



ADSON-BROWN
14.0904 12 cm 9x9



BROWN
 14.0910 15 cm
 14.0912 20 cm
 14.0914 25 cm



LANE
 14.0920 14,5 cm 1x2
 14.0922 20,0 cm 1x2



LANE
 14.0925 14,5 cm 2x3
 14.0927 20,0 cm 2x3



RUSSIAN
 14.0930 15 cm
 14.0932 20 cm
 14.0934 25 cm



MAYO-RUSSIAN
 14.0940 23 cm



WANGENSTEEN
 14.0948 23 cm



SINGLEY (TUTTLE)
 14.0950 15 cm
 14.0952 18 cm
 14.0954 23 cm



STILLE-BARRAYA

- 14.0960 18 cm
- 14.0962 20 cm
- 14.0964 25 cm



WAUGH

- 14.0968 15 cm
- 14.0970 20 cm



14.0980
14,5 cm



14.0982
16 cm



14.0984
20 cm

DURANTE



DENIS-BROWN
14.0988 18 cm

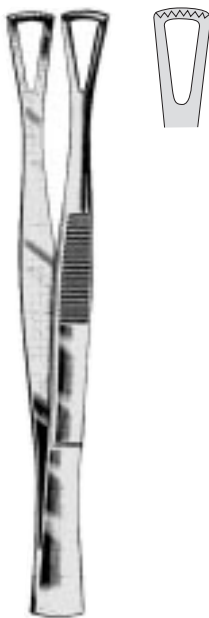

DUVAL
14.0990 14,5 cm



COLLIN-DUVAL
14.0994 20 cm, 14 mm
14.0996 20 cm, 18 mm
14.0998 20 cm, 27 mm

TITANIUM



DEBAKEY

- 14.1000 15 cm / 1,5 mm
- 14.1002 20 cm / 1,5 mm
- 14.1004 24 cm / 1,5 mm
- 14.1006 30 cm / 1,5 mm



DEBAKEY

- 14.1007 T 16 cm / 1,5 mm
- 14.1008 T 20 cm / 1,5 mm
- 14.1009 T 24 cm / 1,5 mm



DEBAKEY

- 14.1010 15 cm/2 mm
- 14.1010T 15 cm/2 mm
- 14.1012 20 cm/2 mm
- 14.1012T 20 cm/2 mm
- 14.1014 24 cm/2 mm
- 14.1014T 24 cm/2 mm
- 14.1016 30 cm/2 mm
- 14.1016T 30 cm/2 mm



DEBAKEY

- 14.1017 T 16 cm/1,8 mm
- 14.1018 T 20 cm/1,8 mm
- 14.1019 T 24 cm/1,8 mm



DEBAKEY

- 14.1021 16 cm /2 mm
- 14.1021T 16 cm /2 mm
- 14.1023 20 cm /2 mm
- 14.1023T 20 cm /2 mm
- 14.1025 24 cm /2 mm
- 14.1025T 24 cm /2 mm
- 14.1027 30 cm /2 mm
- 14.1027T 30 cm /2 mm



DEBAKEY

- 14.1030 16 cm /2,7 mm
- 14.1030T 16 cm /2,7 mm
- 14.1032 20 cm /2,7 mm
- 14.1032T 20 cm /2,7 mm
- 14.1034 24 cm /2,7 mm
- 14.1034T 24 cm /2,7 mm
- 14.1036 30 cm /2,7 mm
- 14.1036T 30 cm /2,7 mm

TITANIUM



DEBAKEY

- 14.1040 15 cm /3,5 mm
- 14.1040T 15 cm /3,5 mm
- 14.1042 20 cm /3,5 mm
- 14.1042T 20 cm /3,5 mm
- 14.1044 24 cm /3,5 mm
- 14.1044T 24 cm /3,5 mm
- 14.1046 30 cm /3,5 mm
- 14.1046T 30 cm /3,5 mm



COOLEY

- 14.1050 15 cm /2 mm
- 14.1050T 15 cm /2 mm
- 14.1052 20 cm /2 mm
- 14.1052T 20 cm /2 mm
- 14.1054 24 cm /2 mm
- 14.1054T 24 cm /2 mm



DEBAKEY

- 14.1060 15 cm /1 mm
- 14.1060T 15 cm /1 mm
- 14.1062 20 cm /1 mm
- 14.1062T 20 cm /1 mm
- 14.1064 24 cm /1 mm
- 14.1064T 24 cm /1 mm

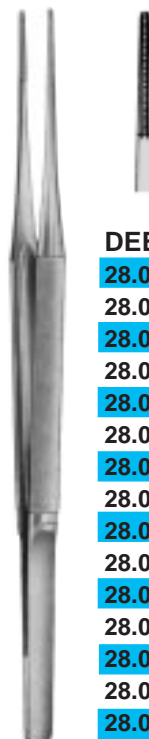

DEBAKEY

- 28.0320 15 cm /1,2 mm TITAN
- 28.0320S 15 cm /1,2 mm
- 28.0322 18 cm /1,2 mm TITAN
- 28.0322S 18 cm /1,2 mm
- 28.0324 21 cm /1,2 mm TITAN
- 28.0324S 21 cm /1,2 mm
- 28.0326 23 cm /1,2 mm TITAN
- 28.0326S 23 cm /1,2 mm
- 28.0330 15 cm /2,0 mm TITAN
- 28.0330S 15 cm /2,0 mm
- 28.0332 18 cm /2,0 mm TITAN
- 28.0332S 18 cm /2,0 mm
- 28.0334 21 cm /2,0 mm TITAN
- 28.0334S 21 cm /2,0 mm
- 28.0336 23 cm /2,0 mm TITAN
- 28.0336S 23 cm /2,0 mm



GLASSMANN



14.1070
15 cm 4 mm



14.1072
24 cm 8 mm

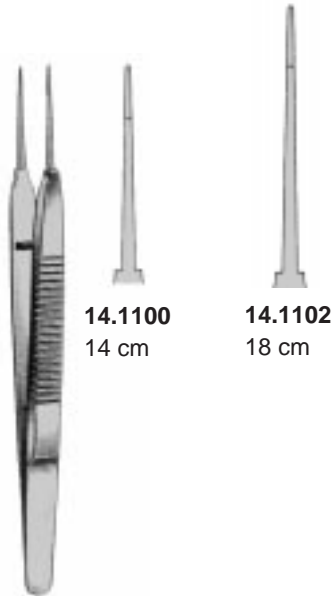

14.1100
14 cm

14.1102
18 cm

AUSTIN



WISE
14.1110
12 cm 0,3 mm



WISE
14.1112
13,5 cm 0,3 mm



WISE
14.1113
13,5 cm 0,3 mm

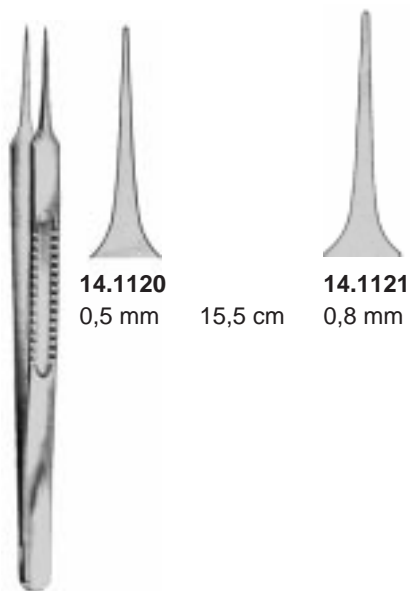

14.1120
0,5 mm 15,5 cm

14.1121
0,8 mm

LAZAR



LAZAR
14.1122
18,5 cm 0,5 mm



14.1510
10,5 cm



14.1511
10,5 cm

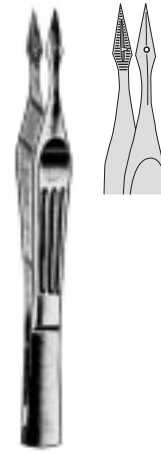

CARMALT
14.1520 10,5 cm

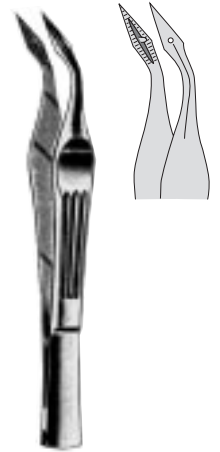

CARMALT
14.1521 10,5 cm

- | | |
|------------------------|------------------------|
| 14.1500 9,0 cm | 14.1505 9,0 cm |
| 14.1501 10,0 cm | 14.1506 10,0 cm |
| 14.1502 11,5 cm | 14.1507 11,5 cm |
| 14.1503 13,0 cm | 14.1508 13,0 cm |
| 14.1504 14,0 cm | 14.1509 14,0 cm |

HUNTER

Mikroskopiepinzetten
 Microscopic Forceps
 Pinzes à microscopie
 Pinzas para microscopia
 Pinze per microscopia



14.1530
7,5 cm



14.1532
9,0 cm



14.1534
11,5 cm



FEILCHENFELD



14.1540
10 cm



14.1542
10 cm



PEET
 14.1560
 11,5 cm

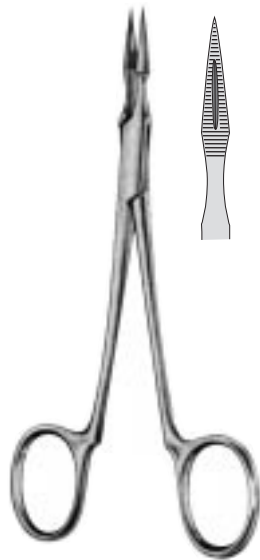

ARTHUR
 14.1570
 14cm

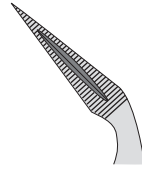

14.1571
 14 cm



STIEGLITZ
 14.1580
 14 cm

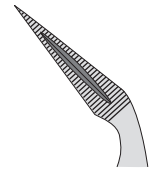

14.1581
 14 cm

Deckglaspinzetten / Cover glass forceps / Pincès port-laminaires /
 Pinzas porta-laminilla / Pinze con copertura vetrificata



VIRTUS (RALK)

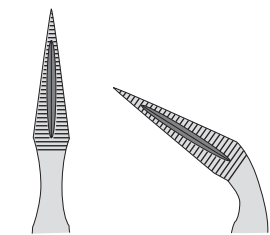

14.1590

14.1591



KUEHNE
 14.1700
 10,5 cm



KUEHNE
 14.1702
 10,5 cm



KUEHNE
 14.1705
 10,5 cm



KUEHNE
 14.1707
 10,5 cm



SHAAF
30.2811
9,5 cm



BARRAQUER
30.2840
10,5 cm



DOUGLAS
30.2850
9 cm



DOUGLAS
30.2852
9 cm



BEER
30.2862
9 cm



BERGH
30.2865
9 cm



LITTAUER
30.2870
8,5 cm



HENRY
30.2885
12 cm



14.2001 12 cm
 glatt / smooth
 lisse / lisa / liscio



ADSON

14.2000 12 cm
14.2002 15 cm

ADSON

14.2005 12 cm 1x2
14.2007 15 cm 1x2

SEMKEN

14.2010 15 cm

CUSHING

14.2020 18 cm

CUSHING

14.2021 18 cm



1.8 mm



2.7 mm

CUSHING

14.2023 19 cm

POTTS-SMITH

14.2049 15 cm
14.2050 18 cm
14.2052 21 cm
14.2054 25 cm

WANGENSTEEN

14.2070 15 cm
14.2072 23 cm
14.2074 25 cm

DRESSING

14.2103 14,5 cm
14.2105 16,0 cm
14.2107 18,0 cm
14.2108 20,0 cm
14.2109 25,0 cm
14.2110 30,0 cm

DRESSING

14.2122 13,0 cm
14.2123 14,5 cm
14.2125 16,0 cm
14.2127 18,0 cm
14.2128 20,0 cm
14.2129 25,0 cm
14.2130 30,0 cm



MC INDOE
 14.2170 15 cm



DEBAKEY
 14.2200
 15 cm / 1,5 mm
 14.2202
 19 cm / 1,5 mm
 14.2204
 24 cm / 1,5 mm



DEBAKEY
 14.2210
 15 cm / 2 mm
 14.2212
 19 cm / 2 mm
 14.2214
 24 cm / 2 mm



DEBAKEY
 14.2220
 15 cm / 2,7 mm
 14.2222
 19 cm / 2,7 mm
 14.2224
 24 cm / 2,7 mm

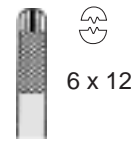

DEBAKEY
 14.2230
 15 cm / 3,5 mm
 14.2232
 19 cm / 3,5 mm
 14.2234
 24 cm / 3,5 mm



DEBAKEY
 14.2240
 15 cm / 2 mm
 14.2242
 19 cm / 2 mm
 14.2244
 24 cm / 2 mm



GERALD
 14.2320 18 cm



BONNEY
 14.2390 18 cm



GERALD
 14.2820 18 cm 1x2



GILLIES
 14.2570 15 cm 1x2



OEHLER
14.2623 14 cm
14.2625 16 cm
14.2627 18 cm
14.2628 20 cm
14.2629 25 cm
14.2630 30 cm



BONNEY
14.2890 18 cm 1x2



ADSON-BROWN
14.2900 12 cm 9x9

Alle gezeigten Koagulationspinzetten sind auch mit "2-Pin"-Stecker lieferbar. Bitte bestellen Sie die gewünschte Figur mit dem Zusatz "-2" (z.B. 14.3000-2)



All Coagulation Forceps are also available with "2-pin"-plug. Please order as follows: "14.3000-2" etc.

Toutes les pinces à coaguler sont également disponibles avec fiche <<2-pin>>. Merci d'ajouter <<2>> au numéro d'article (par ex.: <<14.3000-2 >>)

Todas las pinzas para coagulación también son disponibles con 2-pin clavija. Para un pedido encarge por ejemplo: "14.3000-2" etc.

Tutte le Pinze per Coagulazione sono disponibili anche nella versione con spina a due pin. Ordinare come segue: "14.3000-2", ecc.



COAGULATING

14.3000 11 cm/0,25 mm

14.3002 11 cm/0,6 mm



COAGULATING

14.3003 11 cm/0,25 mm

14.3005 11 cm/0,6 mm



COAGULATING

14.3007 11 cm/0,25 mm

14.3009 11 cm/0,6 mm

BIPOLARE KOAGULATIONSPINZETTEN
BIPOLAR COAGULATION FORCEPS
PINCES A COAGULATION BIPOLAIRE
PINZAS PARA COAGULACIÓN BIPOLAR
PINZE PER COAGULAZIONE BIPOLARE

PRO-MED

Alle gezeigten Koagulationspinzetten sind auch mit "2-Pin"-Stecker lieferbar. Bitte bestellen Sie die gewünschte Figur mit dem Zusatz "-2" (z.B. 14.3100-2)

All Coagulation Forceps are also available with "2-pin"-plug. Please order as follows: "14.3100-2" etc.

Toutes les pinces à coaguler sont également disponibles avec fiche <<2-pin>>. Merci d'ajouter <<-2>> au numéro d'article (par ex.: <<14.3100-2>>)

Todas las pinzas para coagulación también son disponible con 2-pin clavija. Para un pedido encarge por ejemplo: "14.3100-2" etc.

Tutte le Pinze per Coagulazione sono disponibili anche nella versione con spina a due pin.
 Ordinare come segue: "14.3100-2", ecc.



COAGULATING

14.3100 15 cm/0,3 mm

14.3110 15 cm/1,0 mm

14.3120 15 cm/2,0 mm

COAGULATING

14.3102 18 cm/0,3 mm

14.3112 18 cm/1,0 mm

14.3122 18 cm/2,0 mm

COAGULATING

14.3104 20 cm/0,3 mm

14.3114 20 cm/1,0 mm

14.3124 18 cm/2,0 mm

COAGULATING

14.3106 22 cm/0,3 mm

14.3116 22 cm/1,0 mm

14.3126 22 cm/2,0 mm

COAGULATING

14.3108 24 cm/0,3 mm

14.3118 24 cm/1,0 mm

14.3128 24 cm/2,0 mm

Alle gezeigten Koagulationspinzetten sind auch mit "2-Pin"-Stecker lieferbar. Bitte bestellen Sie die gewünschte Figur mit dem Zusatz "-2" (z.B. 14.3141-2)

All Coagulation Forceps are also available with "2-pin"-plug. Please order as follows: "14.3141-2" etc.

Toutes les pinces à coaguler sont également disponibles avec fiche <<2-pin>>. Merci d'ajouter <<-2>> au numéro d'article (par ex.: <<14.3141-2 >>)

Todas las pinzas para coagulación también son disponibles con 2-pin clavija. Para un pedido encarge por ejemplo: "14.3141-2" etc.

Tutte le Pinze per Coagulazione sono disponibili anche nella versione con spina a due pin. Ordinare come segue: "14.3141-2", ecc.



COAGULATING
14.3141 15 cm/0,3 mm
14.3151 15 cm/1,0 mm
14.3161 15 cm/2,0 mm

COAGULATING
14.3143 18 cm/0,3 mm
14.3153 18 cm/1,0 mm
14.3163 18 cm/2,0 mm

COAGULATING
14.3145 20 cm/0,3 mm
14.3155 20 cm/1,0 mm
14.3165 20 cm/2,0 mm

COAGULATING
14.3147 22 cm/0,3 mm
14.3157 22 cm/1,0 mm
14.3167 22 cm/2,0 mm

COAGULATING
14.3149 24 cm/0,3 mm
14.3159 24 cm/1,0 mm
14.3169 24 cm/2,0 mm

BIPOLARE KOAGULATIONSPINZETTEN
BIPOLAR COAGULATION FORCEPS
PINCES A COAGULATION BIPOLAIRE
PINZAS PARA COAGULACIÓN BIPOLAR
PINZE PER COAGULAZIONE BIPOLARE

PRO-MED

Alle gezeigten Koagulationspinzetten sind auch mit "2-Pin"-Stecker lieferbar. Bitte bestellen Sie die gewünschte Figur mit dem Zusatz "-2" (z.B. 14.3061-2)

All Coagulation Forceps are also available with "2-pin"-plug. Please order as follows: "14.3061-2" etc.

Toutes les pinces à coaguler sont également disponibles avec fiche <<2-pin>>. Merci d'ajouter <<-2>> au numéro d'article (par ex.: <<14.3061-2 >>)

Todas las pinzas para coagulación también son disponibles con 2-pin clavija. Para un pedido encarga por ejemplo: "14.3061-2" etc.

Tutte le Pinze per Coagulazione sono disponibili anche nella versione con spina a due pin. Ordinare come segue: "14.361-2", ecc.



COAGULATING

14.3061 17 cm/0,3 mm

14.3071 17 cm/1,0 mm

14.3081 17 cm/2,0 mm



COAGULATING

14.3202 18 cm/0,3 mm

14.3212 18 cm/1,0 mm

14.3222 18 cm/2,0 mm



COAGULATING

14.3204 20 cm/0,3 mm

14.3214 20 cm/1,0 mm

14.3224 20 cm/2,0 mm

Alle gezeigten Koagulationspinzetten sind auch mit "2-Pin"-Stecker lieferbar. Bitte bestellen Sie die gewünschte Figur mit dem Zusatz "-2" (z.B. 14.3206-2)

All Coagulation Forceps are also available with "2-pin"-plug. Please order as follows: "14.3206-2" etc.

Toutes les pincés à coaguler sont également disponibles avec fiche <<2-pin>>. Merci d'ajouter <<-2>> au numéro d'article (par ex.: <<14.3206-2 >>)

Todas las pinzas para coagulación también son disponibles con 2-pin clavija. Para un pedido encarge por ejemplo: "14.3206-2" etc.

Tutte le Pinze per Coagulazione sono disponibili anche nella versione con spina a due pin. Ordinare come segue: "114.3206", ecc.



COAGULATING

14.3206 22 cm/0,3 mm

14.3216 22 cm/1,0 mm

14.3226 22 cm/2,0 mm



COAGULATING

14.3208 24 cm/0,3 mm

14.3218 24 cm/1,0 mm

14.3228 24 cm/2,0 mm

BIPOLAR-Kabel 3 m, f. Bipolpinzetten mit Flachstecker

Cables 3 mtr. for Forceps with flat plug

Cordons 3 mtr. pour pinces avec fiches plats

Cables 3 mtr. para pinzas con clavijas plano

Cavi 3 mtr. per pinze con spine piatto



14.3900

2-Bananenstecker
2-banana-plug
fiche 2-bananas
clavija 2-bananas
spina "2 banani"



BIPOLAR-Kabel 3 m, f. Bipolpinzetten mit "2-Pin"-Stecker

Cables 3 mtr. for Forceps with "2-pin"-plug

Cordons 3 mtr. pour pinces avec fiches <<2-pin>>

Cables 3 mtr. para pinzas con 2-pin clavija

Cavi 3 mtr. per pinze con spina a due pin



14.3905

2-Bananenstecker
2-banana-plug
fiche 2-bananas
clavija 2-bananas
spina "2 banani"

14.3910

Model Erbe
Model Erbe
Modèle Erbe
Modelo Erbe
Modello Erbe



14.3915

Model Erbe
Model Erbe
Modèle Erbe
Modelo Erbe
Modello Erbe

14.3920

Model Martin
Model Martin
Modèle Martin
Modelo Martin
Modello Martin



14.3925

Model Martin
Model Martin
Modèle Martin
Modelo Martin
Modello Martin

14.3930

Model Valleylab
Model Valleylab
Modèle Valleylab
Modelo Valleylab
Modello Valleylab



14.3935

Model Valleylab
Model Valleylab
Modèle Valleylab
Modelo Valleylab
Modello Valleylab

14.3940

Model Aesculap GK50
Model Aesculap GK50
Modèle Aesculap GK50
Modelo Aesculap GK50
Modello Aesculap GK50



14.3945

Model Aesculap GK50
Model Aesculap GK50
Modèle Aesculap GK50
Modelo Aesculap GK50
Modello Aesculap GK50

14.3950

Model Codman CMC II
Model Codman CMC II
Modèle Codman CMC II
Modelo Codman CMC II
Modello Codman CMC II



14.3955

Model Codman CMC II
Model Codman CMC II
Modèle Codman CMC II
Modelo Codman CMC II
Modello Codman CMC II



LONDON-COLLEGE

- 14.6001 #1
- 14.6002 #2
- 14.6003 #3
- 14.6004 #4
- 14.6005 #5
- 14.6006 #6

LONDON-COLLEGE

- 14.6011 #1
- 14.6012 #2
- 14.6013 #3
- 14.6014 #4
- 14.6015 #5
- 14.6016 #6

LONDON-COLLEGE

- 14.6031 #1
- 14.6032 #2
- 14.6033 #3
- 14.6034 #4
- 14.6035 #5
- 14.6036 #6

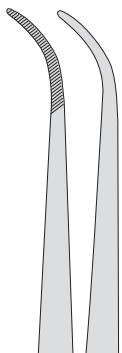

1

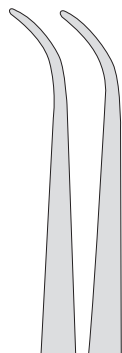

2

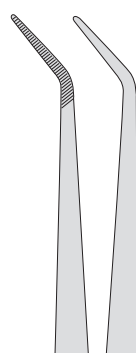

3



4

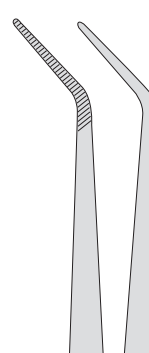

5

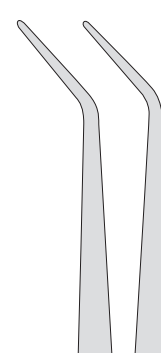

6



MERIAM

- 14.6201 16 cm #1
- 14.6202 16 cm #2
- 14.6203 16 cm #3
- 14.6204 16 cm #4
- 14.6205 16 dm #5
- 14.6206 16 cm #6

MERIAM

- 14.6211 16 cm #1
- 14.6212 16 cm #2
- 14.6213 16 cm #3
- 14.6214 16 cm #4
- 14.6215 16 cm #5
- 14.6216 16 cm #6

FLAGG

- 14.6251 16 cm #1
- 14.6252 16 cm #2
- 14.6253 16 cm #3
- 14.6254 16 cm #4

FLAGG

- 14.6261 16 cm #1
- 14.6262 16 cm #2
- 14.6263 16 cm #3
- 14.6264 16 cm #4

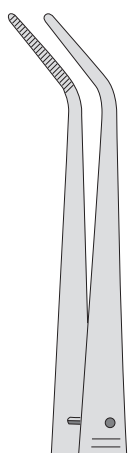

1

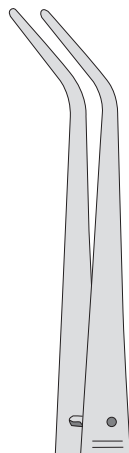

2

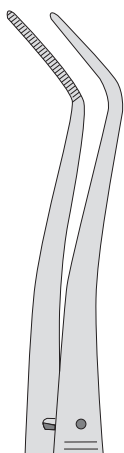

3

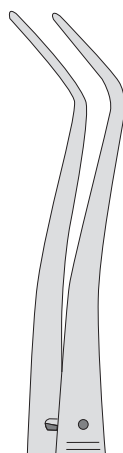

4

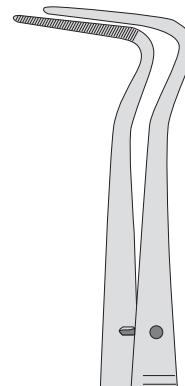

5

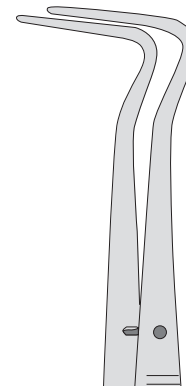

6

Hypophysenpinzetten
 Hypophyseal forceps
 Pincès à hypophyse
 Pinzas para hipofisis
 Pize per ipofisi



ADSON
 27.2500 18,5 cm



HOEN
 20cm

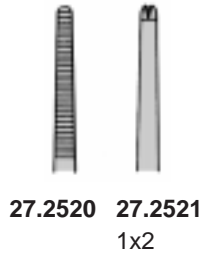

27.2520 27.2521
 1x2



ADSON
 27.2540 23 cm



ADSON
 27.2541 23 cm



ADSON
 27.2542 23 cm



SCOVILLE
 22 cm



27.2560
 10 mm



27.2562
 13 mm



JACOBSEN-MICRO

28.0011 11 cm

28.0015 15 cm

28.0018 18 cm



JACOBSEN-ADSON

28.0030 12 cm



JACOBSEN-ADSON

28.0032 15 cm



28.0080



28.0081

12 cm / 8 mm



28.0082



28.0083

15 cm / 8 mm

Mikro-Knüpfpinzetten
Micro Suture Forceps
Micro Pincès à sutures
Micro pinzas para suturas
Micro-pinze per ligature



18 cm / 8 mm



28.0084



28.0085



21 cm / 8 mm



28.0086



28.0087

Tumor- und Gewebefaßpinzetten
Tumor- and Tissue Grasping Forceps
Pinces pour saisir tumeurs et tissus
Pinzas para coger tejidos y tomores
Pinze per afferare tessuti e tumori



HUNT
20 cm

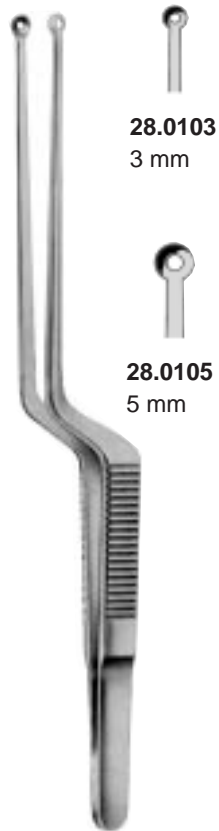

YASARGIL
22 cm

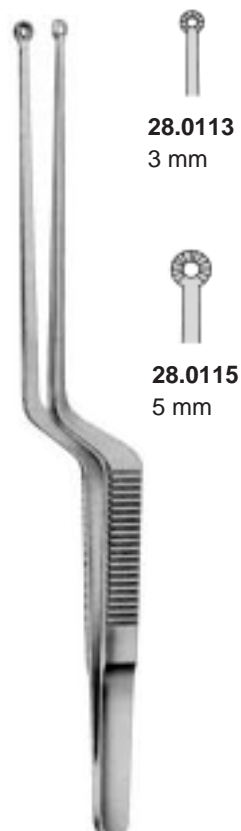

YASARGIL
22 cm

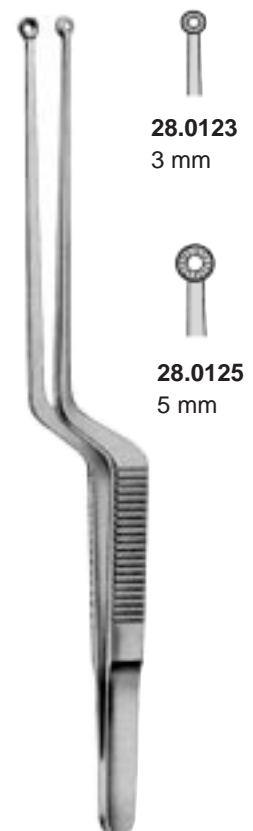

HEIFETZ
22 cm



Diamantbeschichtete Spitzen
 Diamond coated tips
 Avec bouts de diamant
 Puntas con cascós de diamante
 con punte diamantate

TITANIUM



spitz
 sharp
 pointu
 agudo
 appuntato



stumpf
 blunt
 mousse
 romo
 smusso

28.0130 18.5 cm
28.0136 22.5 cm

28.0132 18.5 cm
28.0138 22.5 cm

Mikro-Nahtpinzetten mit Gegengewicht und diamantbeschichteten Spitzen
 Micro-Suturing Forceps counterbalanced with diamond coated tips
 Micro pincés à suture avec contrepoides, bouts de diamant
 Micro pinzas para sutura con contrapeso, puntas con cascós de diamante
 Micro-pinze per sutura con contrappeso, punte diamantate

RHOTON-"BALANCE"

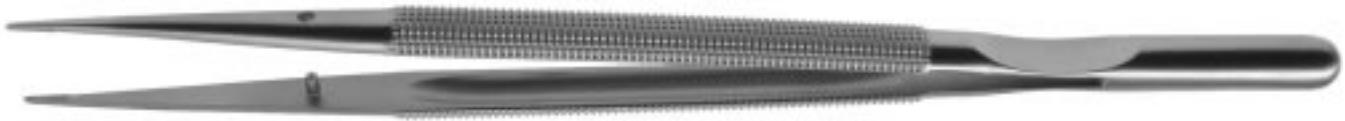

6 x 0,4mm
 18 cm **28.0362SD**
 21 cm **28.0364SD**



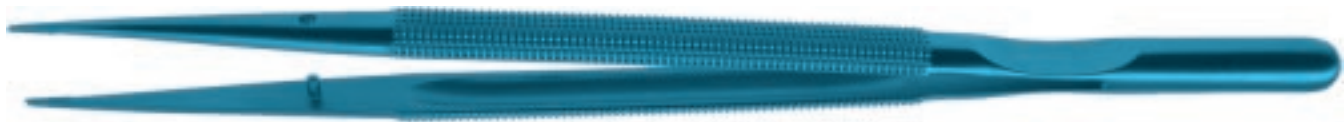

 
 
28.0363SD
28.0365SD

6 x 0,8mm
 18 cm **28.0372SD**
 21 cm **28.0374SD**

 
 
28.0373SD
28.0375SD







6 x 0,4mm
 18 cm **28.0362T**
 21 cm **28.0364T**

 
 
28.0363T
28.0365T

TITANIUM **TITANIUM**

6 x 0,8 mm
 18 cm **28.0372T**
 21 cm **28.0374T**

 
 
28.0373T
28.0375T

TITANIUM **TITANIUM**

TITANIUM



Diamantbeschichtete Spitzen
Diamond coated tips
Avec bouts de diamant
Puntas con cascós de diamante
con punte diamantate

RHOTON



0,4mm		
15 cm	28.0220SD	28.0221SD
18 cm	28.0222SD	28.0223SD
21 cm	28.0224SD	28.0225SD
23 cm	28.0226SD	28.0227SD

0,8mm		
15 cm	28.0230SD	28.0231SD
18 cm	28.0232SD	28.0233SD
21 cm	28.0234SD	28.0235SD
23 cm	28.0236SD	28.0237SD



0,4mm		
15 cm	28.0220T	28.0221T
18 cm	28.0222T	28.0223T
21 cm	28.0224T	28.0225T
23 cm	28.0226T	28.0227T
	TITANIUM	TITANIUM

0,8mm		
15 cm	28.0230T	28.0231T
18 cm	28.0232T	28.0233T
21 cm	28.0234T	28.0235T
23 cm	28.0236T	28.0237T
	TITANIUM	TITANIUM

RHOTON-"BALANCE"

Mikropinzetten mit Gegengewicht und diamantbeschichteten Spitzen
Micro-Forceps counterbalanced with diamond coated tips
Micro pincés avec contrepoids, bouts de diamant
Micro pinzas para con contrapeso, puntas con cascós de diamante
Micro-pinze con contrapeso, punte diamantate



0,4mm		
18 cm	28.0382SD	28.0383SD
21 cm	28.0384SD	28.0385SD

0,8mm		
18 cm	28.0392SD	28.0393SD
21 cm	28.0394SD	28.0395SD

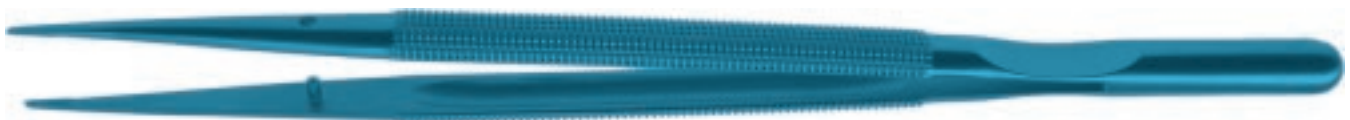

0,4mm		
18 cm	28.0382T	28.0383T
21 cm	28.0384T	28.0385T
	TITANIUM	TITANIUM

0,8mm		
18 cm	28.0392T	28.0393T
21 cm	28.0394T	28.0395T
	TITANIUM	TITANIUM









TITANIUM











Diamantbeschichtete Spitzen
 Diamond coated tips
 Avec bouts de diamant
 Puntas con cascós de diamante
 con punte diamantate

RHOTON



					
6 x 0,4mm			6 x 0,8 mm		
15 cm	28.0260SD	28.0261SD	15 cm	28.0270SD	28.0271SD
18 cm	28.0262SD	28.0263SD	18 cm	28.0272SD	28.0273SD
21 cm	28.0264SD	28.0265SD	21 cm	28.0274SD	28.0275SD
23 cm	28.0266SD	28.0267SD	23 cm	28.0276SD	28.0277SD



					
6 x 0,4mm			6 x 0,8 mm		
15 cm	28.0260T	28.0261T	15 cm	28.0270T	28.0271T
18 cm	28.0262T	28.0263T	18 cm	28.0272T	28.0273T
21 cm	28.0264T	28.0265T	21 cm	28.0274T	28.0275T
23 cm	28.0266T	28.0267T	23 cm	28.0276T	28.0277T

TITANIUM

TITANIUM

TITANIUM

TITANIUM

TITANIUM



Diamantbeschichtete Spitzen
Diamond coated tips
Avec bouts de diamant
Puntas con cascos de diamante
con punte diamantate

RHOTON



6 x 0,4mm			6 x 0,8 mm		
15 cm	28.0280SD	28.0281SD	15 cm	28.0290SD	28.0291SD
18 cm	28.0282SD	28.0283SD	18 cm	28.0292SD	28.0293SD
21 cm	28.0284SD	28.0285SD	21 cm	28.0294SD	28.0295SD
23 cm	28.0286SD	28.0287SD	23 cm	28.0296SD	28.0297SD



6 x 0,4mm			6 x 0,8 mm		
15 cm	28.0280T	28.0281T	15 cm	28.0290T	28.0291T
18 cm	28.0282T	28.0283T	18 cm	28.0292T	28.0293T
21 cm	28.0284T	28.0285T	21 cm	28.0294T	28.0295T
23 cm	28.0286T	28.0287T	23 cm	28.0296T	28.0297T
	TITANIUM	TITANIUM		TITANIUM	TITANIUM

TITANIUM



Diamantbeschichtete Spitzen
 Diamond coated tips
 Avec bouts de diamant
 Puntas con cascos de diamante
 con punte diamantate



RHOTON

1 x 0,5mm

15 cm
 18 cm
 21 cm
 23 cm

TITANIUM



28.0240SD
28.0242SD
28.0244SD
28.0246SD



2 x 1,0 mm

15 cm
 18 cm
 21 cm
 23 cm

TITANIUM



28.0250SD
28.0252SD
28.0254SD
28.0256SD

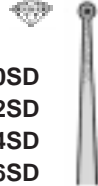

Mikro-Ringpinzetten mit Gegengewicht und diamantbeschichteten Spitzen
 Micro Ring Forceps counterbalanced with diamond coated tips
 Micro pinces à anneau avec contrepoides, bouts de diamant
 Micro pinzas con ojal y contrapeso, puntas con cascos de diamante
 Micro-pinze con anello e contrappeso, punte diamantate

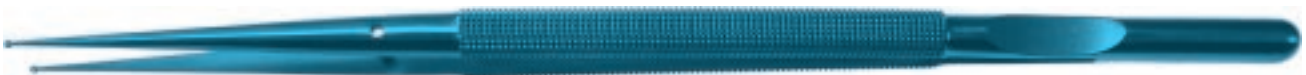
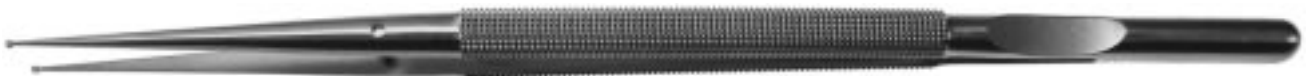

RHOTON

1 x 0,5mm

18 cm
 21 cm

TITANIUM



28.0342SD
28.0344SD



2 x 1,0 mm

18 cm
 21 cm

TITANIUM

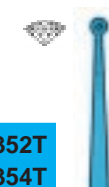

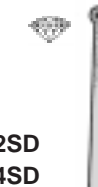

28.0352SD
28.0354SD





TITANIUM



DEBAKEY

		
1,2 mm		
15 cm	28.0320T	28.0320S
18 cm	28.0322T	28.0322S
21 cm	28.0324T	28.0324S
23 cm	28.0326T	28.0326S

TITANIUM

		
1,8 mm		
15 cm	28.0330T	28.0330S
18 cm	28.0332T	28.0332S
21 cm	28.0334T	28.0334S
23 cm	28.0336T	28.0336S

TITANIUM



28.0600 16 cm
28.0602 18 cm
28.0604 20 cm
28.0606 22 cm
28.0608 24 cm

Spitzen 0,6 mm
 Tips 0,6 mm
 bout 0,6 mm
 punta 0,6 mm
 punte 0,6 mm



28.0610 16 cm
28.0612 18 cm
28.0614 20 cm
28.0616 22 cm
28.0618 24 cm

Spitzen 0,9 mm
 Tips 0,9 mm
 bout 0,9 mm
 punta 0,9 mm
 punte 0,9 mm



28.0622 18 cm

1 x 2 Zähne
 1 x 2 teeth
 1 x 2 dents
 1 x 2 dientes
 1 x 2 denti



Ø 3 mm 
YASARGIL
YASARGIL-SAMII
28.0710 22 cm
28.0700 24 cm

Ø 5 mm 
YASARGIL
YASARGIL-SAMII
28.0712 22 cm
28.0702 24 cm

Ø 7 mm 
YASARGIL-SAMII
28.0704 24 cm

löffelförmig
spoon-shaped
en forme de cuillère
forma cuchara
forma di cucchiaio

Ø 3 mm 
YASARGIL
28.0714 22 cm
gezahnt/serrated/
dentelés/dentada/dentate

Ø 3 mm 
HEIFETZ
28.0715 22 cm
gezahnt/serrated/
dentelés/dentada/dentate

Ø 5 mm 
HEIFETZ
28.0717 22 cm
kürettenförmig gezahnt
curette-shaped serrated
en forme de curette dentelés
forma cureta dentada
forma di cucchiaio dentate

Ø 5 mm 
YASARGIL
28.0716 22 cm
flach, gezahnt
flat, serrated
mors plats, dentelés
boca plana, dentada
morsi piatti, dentate

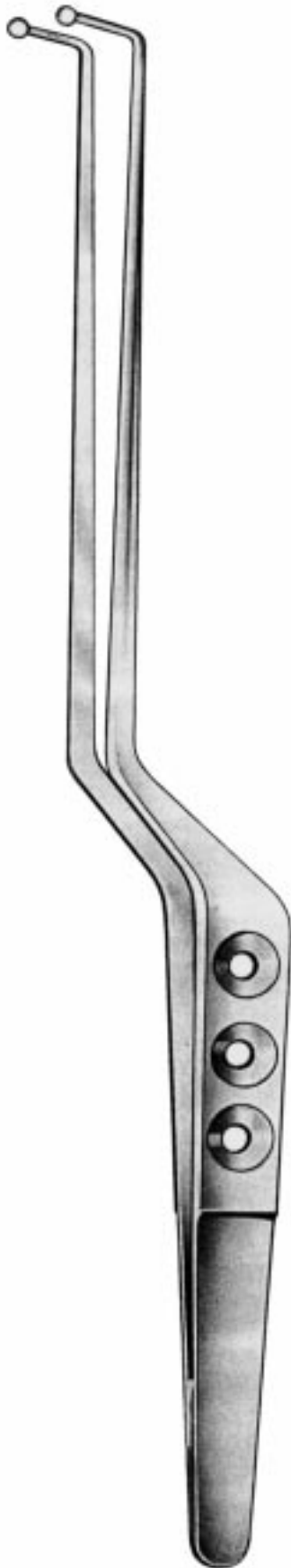

SAMII
23 cm

löffelförmig
spoon-shaped
en forme de cuillère
forma cuchara
forma di cucchiaio

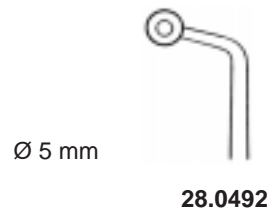
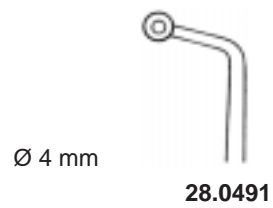
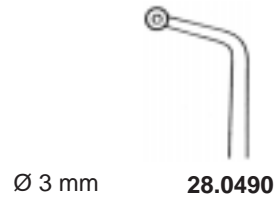



TROELTSCH
32.0640
11 cm



TROELTSCH
32.0642
13 cm



WILDE
32.0650
14 cm



LUCAE
32.0660
14 cm



LUCAE
32.0662
16 cm

Columnella-Pinzette
 Columnella Forceps
 Pnce pour columelle
 Pinza para columela
 Pinza per columella



COTTLE
33.0440
 15 cm



COTTLE
33.0446
 11 cm



TROELTSCH
33.0450
 15 cm



TROELTSCH
33.0452
 18 cm



GRUENWALD
33.0460 16 cm
33.0462 20 cm

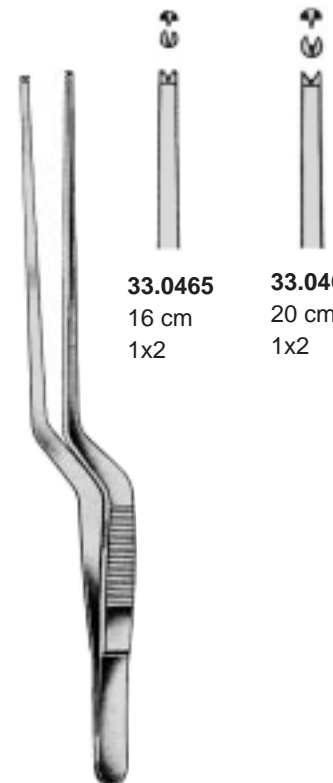

GRUENWALD

33.0465
 16 cm
 1x2

33.0467
 20 cm
 1x2

OPHTHALMOLOGIE • OPHTHALMOLOGY • OFTALMOLOGIA • OPHTHALMOLOGIE • OFTALMOLOGIA

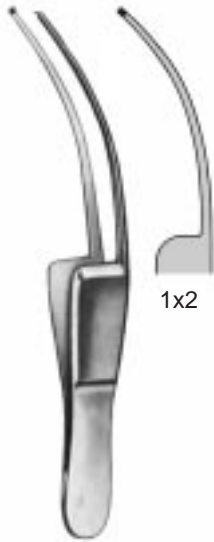

FISHER-ARLT
30.2020
7 cm



GRAEFE
30.2050
7 cm/0,7 mm



GRAEFE
30.2051
7 cm/0,7 mm



GRAEFE
30.2056
7 cm/0,7 mm



GRAEFE
30.2057
7 cm/0,7 mm



STEVENS
30.2062
10 cm



STEVENS
30.2063
10 cm



STEVENS
30.2065
10 cm



STEVENS
30.2066
10 cm



STEVENS
30.2067
10 cm



STEVENS
30.2069
10 cm



FOERSTER
30.2070
8,5 cm/0,8 mm



FOERSTER
30.2071
8,5 cm/0,8 mm



FOERSTER
30.2076
8,5 cm



FOERSTER
30.2077
8,5 cm



BISHOP-HARMAN
30.2080
0,8 mm



BISHOP-HARMAN
30.2082
0,5 mm



BISHOP-HARMAN
30.2086
0,8 mm



BISHOP-HARMAN
30.2088
0,5 mm

OPHTHALMOLOGIE • OPHTHALMOLOGY • OFTALMOLOGIA • OPHTHALMOLOGIE • OFTALMOLOGIA



BONN
30.2090
7 cm / 1x2
mit Führungsstift
with guide pin
avec guide
con guida
con guida



BONN
30.2091
7 cm / 1x2
ohne Führungsstift
without guide pin
sans guide
sin guida
senza guida



BONN
30.2094
10 cm / 1x2



GILL
30.2111
7,5 cm / 1x2



GILL
30.2137
7,5 cm / 1x2

Zähne unten
teeth below
dents en bas
dientes abajo
denti in basso



GILL
30.2138
7,5 cm / 1x2

Zähne seitwärts
lateral teeth
dents latérales
dientes laterales
denti laterali

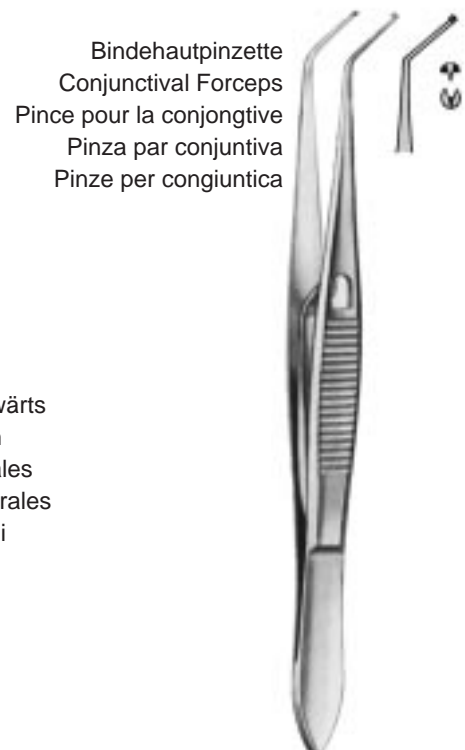

O'CONNOR
30.2170
10 cm / 1x2

Bindehautpinzette
Conjunctival Forceps
Pince pour la conjongtive
Pinza par conjuntiva
Pinze per congiuntica



HESS
30.2140
7 cm / 1x2



HESS
30.2141
7 cm / 1x2



**BARRAQUER-
KATZIN**
30.2150
7 cm / 1x2

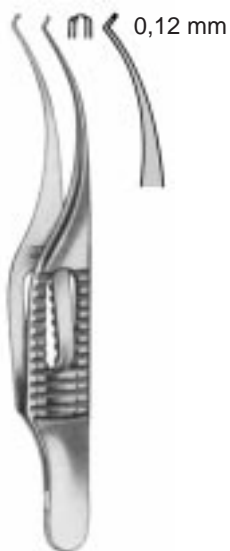

**BARRAQUER-
COLIBRI**
30.2152
7 cm / 1x2



TROUTMAN
30.2154
7 cm / 1x2



BARRAQUER
30.2156
7 cm / 1x2

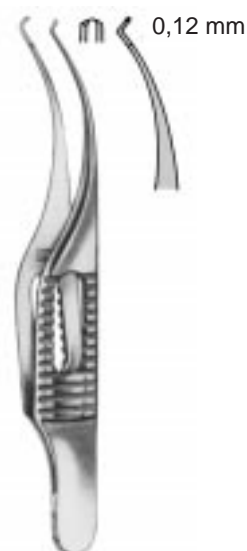

BARRAQUER
30.2158
7 cm / 1x2

OPHTHALMOLOGIE • OPHTHALMOLOGY • OFTALMOLOGIA • OPHTHALMOLOGIE • OFTALMOLOGIA



DERMOT-PIERCE
30.2120
8 cm



DERMOT-PIERCE
30.2121
8 cm



DERMOT-PIERCE
30.2122
8 cm



DERMOT-PIERCE
30.2125
8 cm



DERMOT-PIERCE
30.2126
8 cm



DERMOT-PIERCE
30.2127
8 cm



DERMOT-PIERCE
30.2129
8 cm

OPHTHALMOLOGIE • OPHTHALMOLOGY • OFTALMOLOGIA • OPHTHALMOLOGIE • OFTALMOLOGIA



GRAEFE



30.2300

11 cm

ohne Schloß

without lock

sans verrou

sin cremallera

senza cremagliera



30.2302

11 cm

mit Schloß

with lock

avec verrou

con cremallera

con cremagliera



GREEN

10 cm



30.2310

5 mm

ohne Schloß/without lock/sans verrou/

sin cremallera/senza cremagliera



30.2314

10 mm



30.2312

5 mm

mit Schloß/with lock/avec verrou/

con cremallera/con cremagliera



30.2316

10 mm



BARRAQUER

30.2320

10 cm



ELSCHINIG

30.2330

11 cm



LESTER



30.2350

9 cm / 1x2



30.2352

9 cm / 2x3

OPHTHALMOLOGIE • OPHTHALMOLOGY • OFTALMOLOGIA • OPHTHALMOLOGIE • OFTALMOLOGIA



CASTROVIEJO
30.2380
9 cm / 1x1



CASTROVIEJO
30.2381
9 cm / 1x1



CASTROVIEJO
30.2382
9 cm / 2x2



CASTROVIEJO
30.2383
9 cm / 2x2



EPISKLERAL
30.2390
10 cm

OPHTHALMOLOGIE • OPHTHALMOLOGY • OFTALMOLOGIA • OPHTHALMOLOGIE • OFTALMOLOGIA

TITANIUM



CASTROVIEJO

- 30.2510 10 cm / 0,12 mm
- 30.2512 10 cm / 0,30 mm
- 30.2514 10 cm / 0,50 mm
- 30.2516 10 cm / 1,00 mm
- 30.2518 10 cm / 1,50 mm



CASTROVIEJO

- 30.2515 10 cm / 0,50 mm
- 30.2517 10 cm / 1,00 mm
- 30.2519 10 cm / 1,50 mm



PAUFIGUE

- 30.2520 8,5 cm



PAUFIGUE

- 30.2522 8,5 cm/1x2
- 30.2522T 8,5 cm/1x2



ST.MARTIN

- 30.2530 7 cm



TUEBINGEN

- 30.2540 10 cm



TUEBINGEN

- 30.2542 10 cm



TUEBINGEN

- 30.2543 10 cm



BONN

- 30.2548 10 cm / 1x2

OPHTHALMOLOGIE • OPHTHALMOLOGY • OFTALMOLOGIA • OPHTHALMOLOGIE • OFTALMOLOGIA



McPHERSON
30.2550
 8,5 cm



McPHERSON
30.2551
 8,5 cm



McPHERSON
30.2554
 8,5 cm / 1x2



McPHERSON
30.2555
 8,5 cm / 1x2



McPHERSON
30.2560
 10 cm



McPHERSON
30.2563
 10 cm / 1x2



KELMAN-McPHERSON
30.2570
 10 cm



BARRAQUER
30.2575
 7 cm



MOORFIELD
30.2650
10,5 cm



SCHWEIGGER
30.2687
10 cm



SCHWEIGGER
30.2689
10 cm



BONACCOLTO
30.2725
11 cm

OPHTHALMOLOGIE • OPHTHALMOLOGY • OFTALMOLOGIA • OPHTHALMOLOGIE • OFTALMOLOGIA



ARRUGA
30.2600
10 cm



ARRUGA
30.2602
10 cm



KALT
30.2610
10 cm



CASTROVIEJO
30.2615
10 cm



ELSCHMIG
30.2630
10 cm



TERSON
30.2660
9 cm



FUCHS
30.2682
7 cm



HESS
30.2684
6 cm



HESS
30.2685
6,5 cm

OPHTHALMOLOGIE • OPHTHALMOLOGY • OFTALMOLOGIA • OPHTHALMOLOGIE • OFTALMOLOGIA

Muskelpinzette
Muscular Forceps
Pince musculaire
Pinza muscular
Pinza per muscolo



McCOLLOUGH
30.2700
9,5 cm



McCOLLOUGH
30.2702
9,5 cm / 1x2



TROUTMAN-RECTUS
30.2705
8,5 cm / 1x2

Vorderkammer-Pinzetten / Anterior Chamber Forceps / Pinces pour la chambre antérieure /
Pinzas para la cámara anterior / Pinze per camera anteriore



BARRAQUER
30.2707
5,5 cm



BARRAQUER
30.2708
5,5 cm



BARRAQUER
30.2709
5,5 cm

OPHTHALMOLOGIE • OPHTHALMOLOGY • OFTALMOLOGIA • OPHTHALMOLOGIE • OFTALMOLOGIA



BONACCOLTO
 30.2720
 10 cm



BONACCOLTO
 30.2722
 10 cm



ALABAMA
 30.2730
 9,5 cm



NUGENT
 10 cm



30.2740



30.2742



DASTOOR
 30.2744
 11 cm



DASTOOR
 30.2746
 11 cm / 1x2



DASTOOR
 30.2748
 11 cm / 2x3

OPHTHALMOLOGIE • OPHTHALMOLOGY • OFTALMOLOGIA • OPHTHALMOLOGIE • OFTALMOLOGIA



JAMESON
10 cm

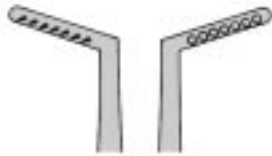

30.2960 **30.2961**
 links rechts
 left right
 à gauche à droite
 izquierda derecha
 sinistra destra



JAMESON
10 cm

Trachompinzette
 Trachona Forceps
 Pince pour le trachome
 Pinza para tracoma
 Pinza per tracoma



KNAPP
30.2900
11 cm



ERHARDT
30.2920 9 cm



links
 left
 à gauche
 izquierda
 sinistra

SNELLEN
30.2930 10 cm



rechts
 right
 à droite
 derecha
 destra

SNELLEN
30.2931 10 cm

OPHTHALMOLOGIE • OPHTHALMOLOGY • OFTALMOLOGIA • OPHTHALMOLOGIE • OFTALMOLOGIA

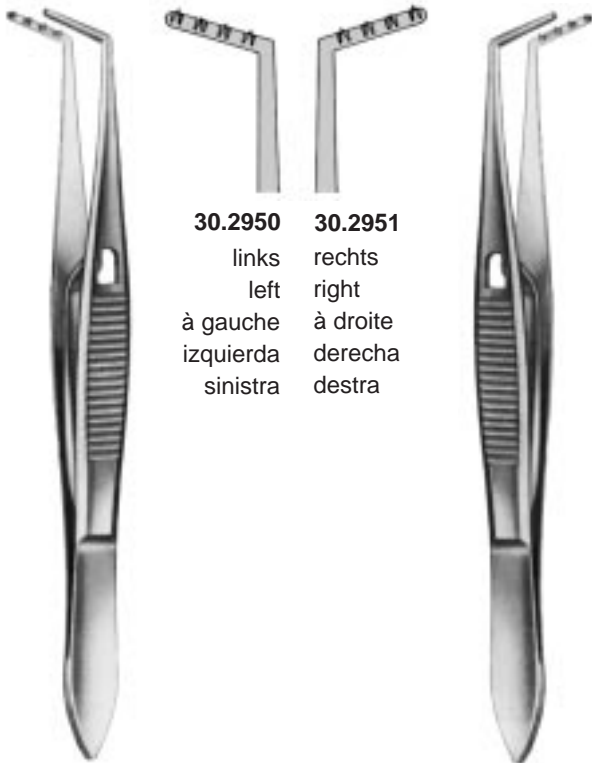

30.2950 links
 left
 à gauche
 izquierda
 sinistra

30.2951 rechts
 right
 à droite
 derecha
 destra

PRINCE

PRINCE

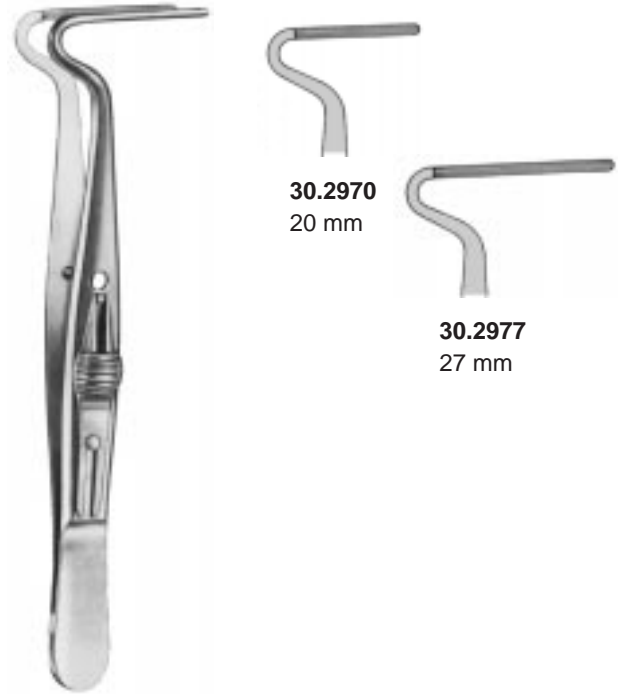

30.2970
 20 mm

30.2977
 27 mm

BERKE



BERENS
30.2980 9 cm

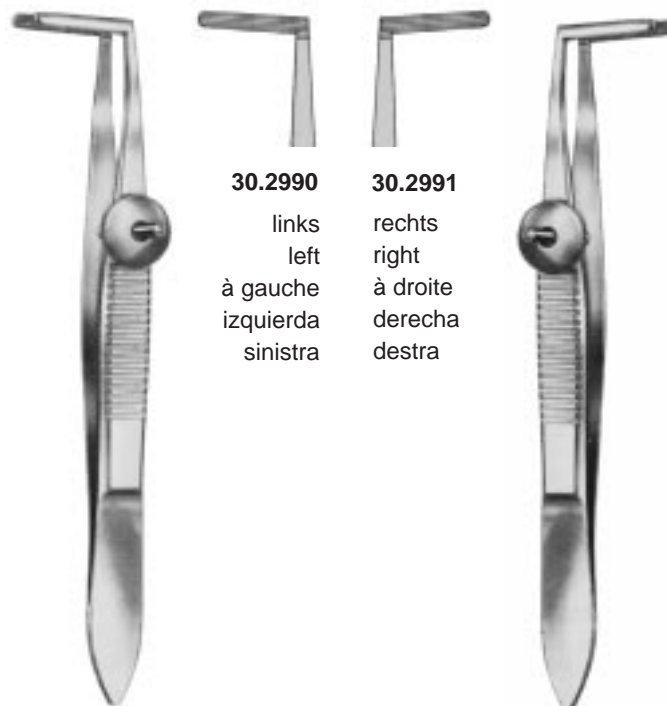

30.2990 links
 left
 à gauche
 izquierda
 sinistra

30.2991 rechts
 right
 à droite
 derecha
 destra

BLASCOVICS
 10 cm

BLASCOVICS
 10 cm

OPHTHALMOLOGIE • OPHTHALMOLOGY • OFTALMOLOGIA • OPHTHALMOLOGIE • OFTALMOLOGIA



DESMARRES
9 cm



30.3000
20 mm



30.3001
26 mm



30.3002
32 mm



AYER
30.3014
9 cm



AYER
30.3015
9 cm



LAMBERT
30.3020
9 cm

OPHTHALMOLOGIE • OPHTHALMOLOGY • OFTALMOLOGIA • OPHTHALMOLOGIE • OFTALMOLOGIA



LORDAN
30.3030
9 cm



HEATH (Hunt)
30.3050
9,5 cm

ARTERIENKLEMMEN, PRÄPARIERKLEMMEN
HEMOSTATIC- AND DISSECTING FORCEPS
PINCES HEMOSTATIQUES ET A PREPARATION
PINZAS HEMOSTATICAS Y PARA PREPARACIONES
PINZE EMOSTATICHE E PER PREPARAZIONE

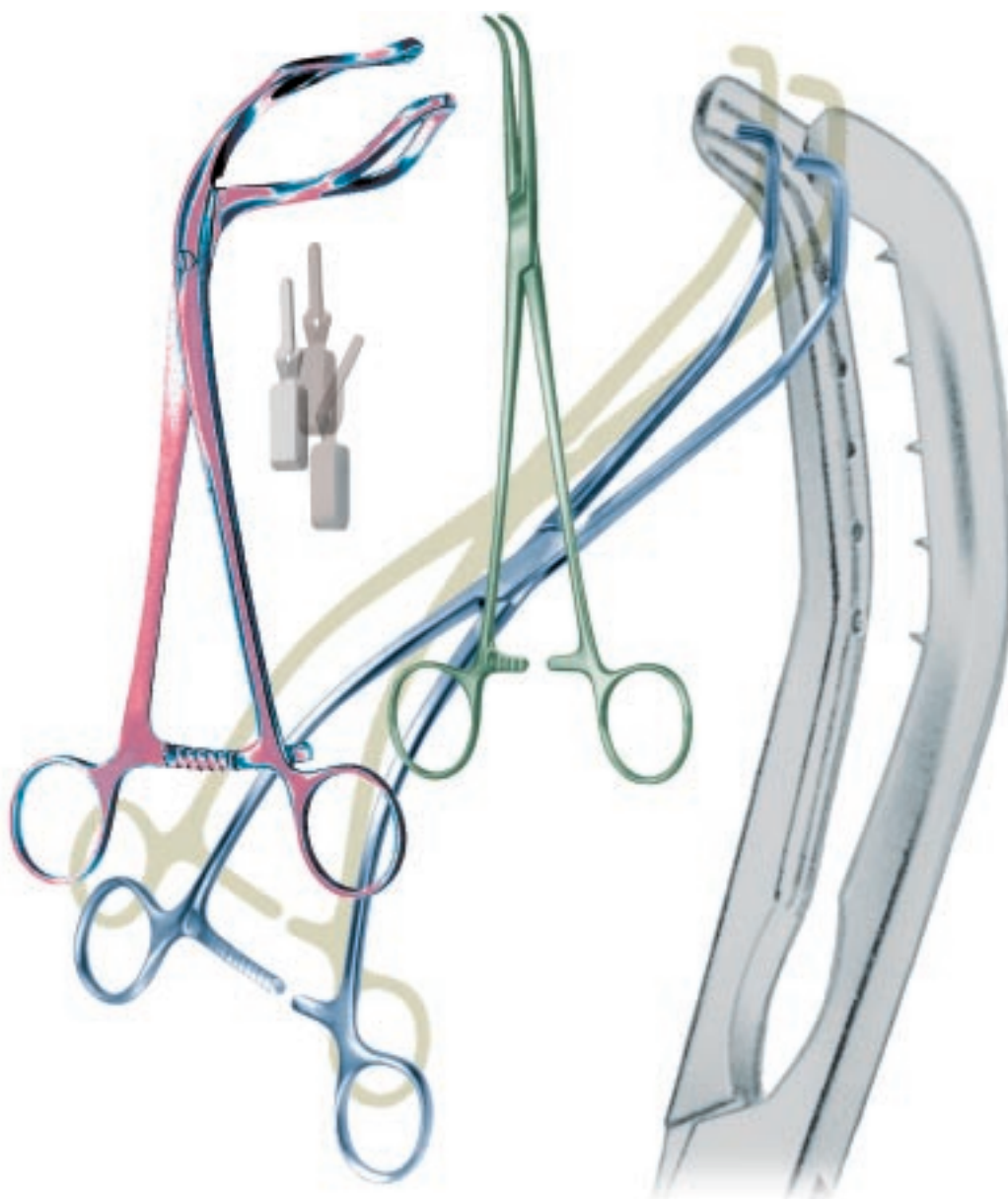



MICRO-CLIP
15.0001
 10 x 2 mm
 60 gr.



MICRO-CLIP
15.0002
 8 x 2 mm
 85 gr.



MICRO-CLIP
15.0003
 6 x 1 mm
 100 gr.



MICRO-CLIP
15.0004
 4 x 0,75 mm
 125 gr.



MICRO-CLIP
15.0005
 6 x 1 mm
 45°, 70 gr.



MICRO-CLIP
15.0006
 6 x 1 mm
 70 gr.



15.0008 14 cm



15.0009 18 cm

Anlegezangen
 applying forceps
 pinces à appliquer
 pinzas para poner
 pinze per applicare



JOHNS-HOPKINS
15.0040 23 cm
 Anlegezange
 applying forceps
 pince à appliquer
 pinza para poner
 pinza per applicare



DIEFFENBACH
15.0010 3,5 cm



DIEFFENBACH
15.0011 3,5 cm



DIEFFENBACH
15.0012 5 cm



DIEFFENBACH
15.0013 5 cm



DIEFFENBACH
15.0014 6 cm

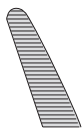

DIEFFENBACH
15.0015 6 cm



JOHNS-HOPKINS
15.0020 38 mm
15.0022 50 mm
15.0024 57 mm
15.0026 63 mm
15.0028 70 mm
15.0030 76 mm
15.0032 90 mm



JOHNS-HOPKINS
15.0021 38 mm
15.0023 50 mm
15.0025 57 mm
15.0027 63 mm
15.0029 70 mm
15.0031 76 mm
15.0033 90 mm



SCHWARTZ
15.0050 25 mm



SCHWARTZ
15.0051 25 mm



SCHWARTZ
15.0053 25 mm



SCHWARTZ
15.0058 19 cm

Anlegezange
Applying forceps
pince à appliquer
pinza para poner
pinza per applicare



MINI-SERREFINE
15.0060 28 mm



MINI-SERREFINE
15.0061 28 mm



GLOVER



GLOVER

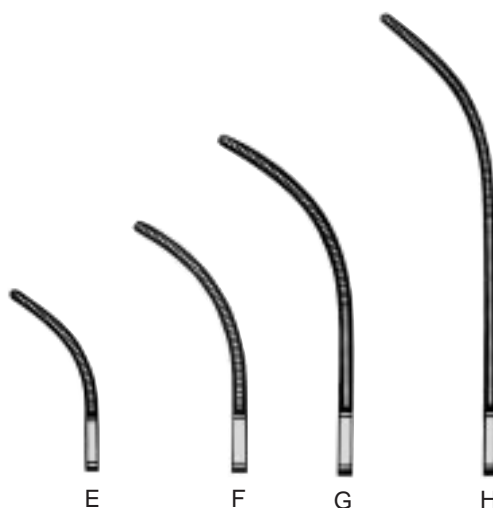

Artikel Item	Fig.	Gesamtlänge Overall length Longeur complet largo total Lunghezza total	Maullänge Jaw length longeur de mors largo de boca Lunghezza del morso	Gewicht Weight Poids Peso Peso
41.0000	A	60 mm	20 mm	5 g
41.0001	E	55 mm	20 mm	5 g
41.0005	B	70 mm	30 mm	9 g
41.0006	F	65 mm	30 mm	9 g
41.0010	C	90 mm	43 mm	12 g
41.0011	G	85 mm	43 mm	12 g
41.0015	D	105 mm	56 mm	14 g
41.0016	H	100 mm	56 mm	14 g
41.0019	J	55 mm	25 mm	7 g



GREGORY

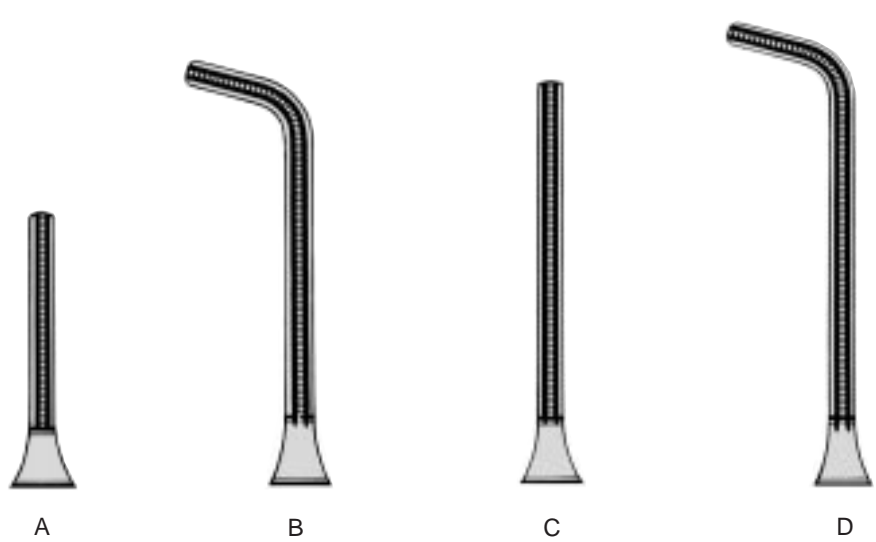

Artikel Item	Fig.	Gesamtlänge Overall length Longeur complet largo total Lunghezza total	Maullänge Jaw length longeur de mors largo de boca Lunghezza del morso	Gewicht Weight Poids Peso Peso
41.0020	A	90 mm	27 mm	11 g
41.0021	B	100 mm	44 mm	12 g
41.0022	C	110 mm	55 mm	12 g
41.0023	D	110 mm	60 mm	12 g



GREGORY

nach links gebogen
 curved to left
 courbe à gauche
 curva a la izquierda
 curvo a sinistra



A

nach rechts gebogen
 curved to right
 courbe à droit
 curva a la derecha
 curvo a destra



B

Artikel Item	Fig.	Gesamtlänge Overall length Longeur complet largo total Lunghezza total	Maullänge Jaw length longeur de mors largo de boca Lunghezza del morso	Gewicht Weight Poids Peso Peso
41.0024	A	110 mm	60 mm	12 g
41.0025	B	110 mm	60 mm	12 g



30 mm Maullänge
 Jaw length
 longueur de mors
 largo de boca
 Lunghezza del morso

SANTULLI
41.0028
 70 mm



DIETRICH

A

B

C

D

E

F

G

Artikel Item	Fig.	Gesamtlänge Overall length Longeur complet largo total Lunghezza total	Maullänge Jaw length longeur de mors largo de boca Lunghezza del morso	Gewicht Weight Poids Peso Peso	Schliesdruck Closing pressure Pression d'Occlusion Presión de cierre Pressione di chiusura
41.0030	A	50 mm	8 mm	3 g	80
41.0031	D	43 mm	8 mm	3 g	80
41.0032	B	53 mm	12 mm	3 g	80
41.0033	E	45 mm	12 mm	3 g	80
41.0034	C	60 mm	20 mm	3 g	80
41.0035	F	50 mm	20 mm	3 g	80
41.0037	G	54 mm	20 mm	3 g	80

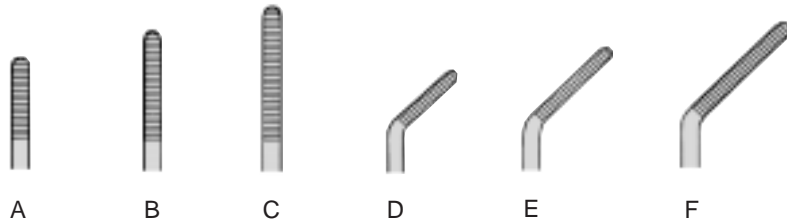

FEDERLEICHT • FEATHERLIGHT • POIDS PLUME • MUY LIGERO

Artikel Item	Fig.	Gesamtlänge Overall length Longeur complet largo total Lunghezza total	Maullänge Jaw length longeur de mors largo de boca Lunghezza del morso	Gewicht Weight Poids Peso Peso	Schliessdruck Closing pressure Pression d'Occlusion Presión de cierre Pressione di chiusura
41.0040	A	31 mm	10 mm	1 g	30
41.0041	B	35 mm	14 mm	1 g	30
41.0042	C	39 mm	18 mm	1 g	30
41.0043	D	30 mm	10 mm	1 g	30
41.0044	E	33 mm	14 mm	1 g	30
41.0045	F	36 mm	18 mm	1 g	30



WICKHAM

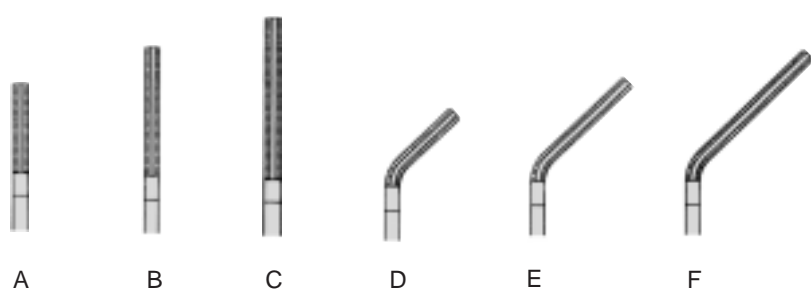

Artikel Item	Fig.	Gesamtlänge Overall length Longeur complet largo total Lunghezza total	Maullänge Jaw length longeur de mors largo de boca Lunghezza del morso	Gewicht Weight Poids Peso Peso	Schliessdruck Closing pressure Pression d'Occlusion Presión de cierre Pressione di chiusura
41.0080	A	49 mm	13 mm	3 g	150
41.0081	D	47 mm	13 mm	3 g	150
41.0082	B	54 mm	18 mm	3 g	150
41.0083	E	51 mm	18 mm	3 g	150
41.0084	C	61 mm	25 mm	3 g	150
41.0085	F	55 mm	25 mm	3 g	150

WICKHAM

41.0089 24 cm

Anlegezange / Applying forceps / Pince à pos / Pinza de aplicación / Pinza per metti-rimovi



TITANIUM

Identification:

A = ARTERIA

= closing force
 220 - 240 ± 10 g

V = VENA

= closing force
 110 - 130 ± 10 g

Anlege- u. Entfernungszange für
 TITAN Miniatur-Bulldog-Clips

Applying- and removing Forceps for
 TITAN Miniature Bulldog-Clips

Pinces pour poser et retirer les
 TITAN Clips Bulldog

Pinza para poner y quitar TITAN
 Miniature clips Bulldog

Pinza per metti-rimouvi TITAN
 Clips Bulldog



3,0 cm

41.0050A
 41.0050V



3,5 cm

41.0052A
 41.0052V



4,0 cm

41.0054A
 41.0054V



4,5 cm

41.0056A
 41.0056V



3,0 cm

41.0051A
 41.0051V



3,5 cm

41.0053A
 41.0053V



4,0 cm

41.0055A
 41.0055V



4,5 cm

41.0057A
 41.0057V



41.0069
 23 cm



3,0 cm

41.0061A
 41.0061V



3,5 cm

41.0063A
 41.0063V



4,0 cm

41.0065A
 41.0065V



4,5 cm

41.0067A
 41.0067V



DEBAKEY-MICRO

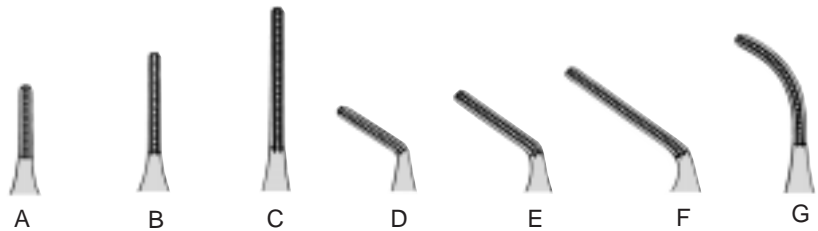

Artikel Item	Fig.	Gesamtlänge Overall length Longeur complet largo total Lunghezza total	Maullänge Jaw length longeur de mors largo de boca Lunghezza del morso	Gewicht Weight Poids Peso Peso	Schliessdruck Closing pressure Pression d'Occlusion Presión de cierre Pressione di chiusura
41.0090	A	47 mm	10 mm	3 g	180
41.0091	D	44 mm	10 mm	3 g	180
41.0092	B	51 mm	14 mm	3 g	180
41.0093	E	46 mm	14 mm	3 g	180
41.0094	C	57 mm	20 mm	3 g	180
41.0095	F	49 mm	20 mm	3 g	180
41.0099	G	54 mm	20 mm	3 g	180



DEBAKEY

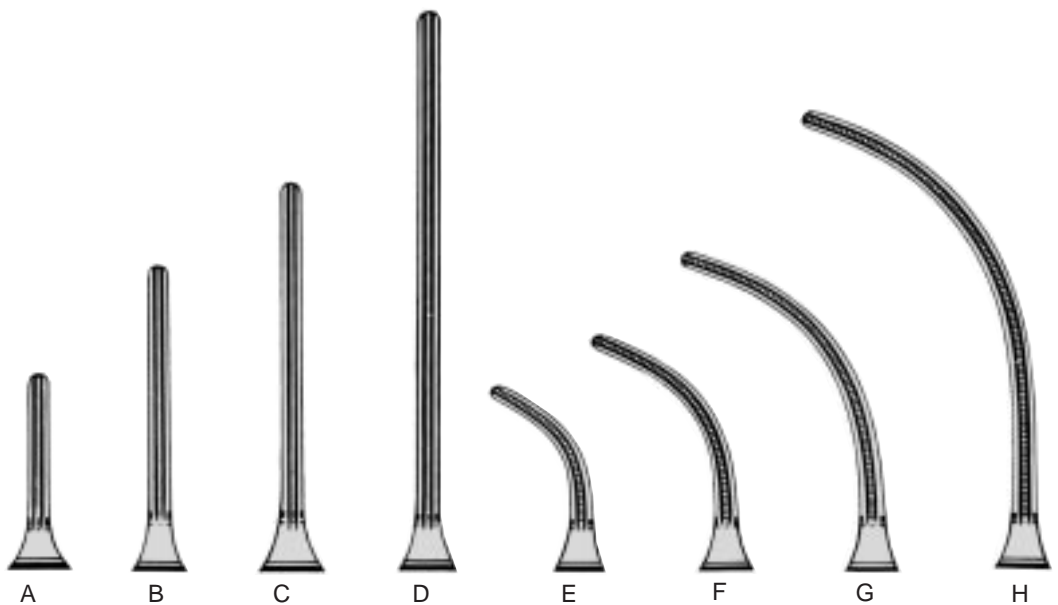

Artikel Item	Fig.	Gesamtlänge Overall length Longeur complet largo total Lunghezza total	Maullänge Jaw length longeur de mors largo de boca Lunghezza del morso	Gewicht Weight Poids Peso Peso
41.0100	A	80 mm	20 mm	10 g
41.0101	E	75 mm	20 mm	10 g
41.0110	B	90 mm	30 mm	11 g
41.0111	F	85 mm	30 mm	11 g
41.0115	C	105 mm	45 mm	12 g
41.0116	G	95 mm	45 mm	12 g
41.0120	D	125 mm	68 mm	12 g
41.0121	H	115 mm	68 mm	12 g



DEBAKEY
41.0130
12.5 cm



DEBAKEY
41.0132
12.5 cm



DEBAKEY
41.0134
12.5 cm 45°



DEBAKEY
41.0136
10 cm 90°



DEBAKEY
41.0138
12.5 cm



DEBAKEY-SATINSKY

41.0140 5,5 cm

41.0144 6,5 cm

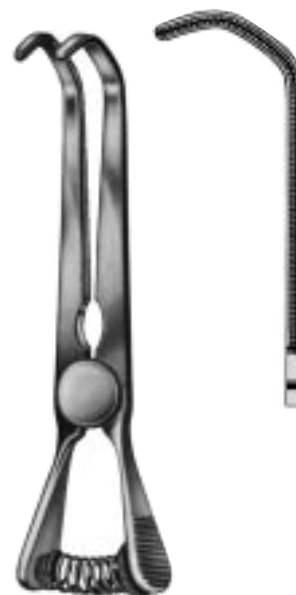

DEBAKEY-SATINSKY

41.0146 10 cm



DEBAKEY-CAROTID

41.0147 9 cm



CARREL
15.0098 8,5 cm



HARTMANN
10 cm



15.0100



15.0108
glattes Maul
smooth jaws
lisses
lisas
liscio



HARTMANN
15.0101 10 cm

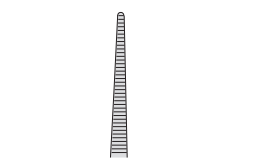

HARTMANN-MICRO
15.0102 10 cm



HARTMANN-MICRO
15.0103 10 cm



HARTMANN
15.0104 10 cm 1x2



HARTMANN
15.0105 10 cm 1x2

TITANIUM



JACOBSON-MICRO
15.0116 12,5 cm

15.0117

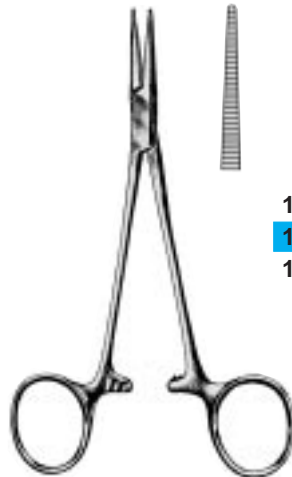

MOSQUITO
15.0120 12,5 cm
15.0120L 12,5 cm
15.0120T 12,5 cm
15.0124 14 cm

15.0121 12,5 cm
15.0121T 12,5 cm
15.0125 14 cm

15.0121L



MICRO-MOSQUITO
15.0122 12,5 cm

15.0123



MICRO-MOSQUITO
15.0128 12 cm 1x2

15.0129 1x2



MOSQUITO
15.0126 12,5 cm 1x2
15.0136 14 cm 1x2

15.0127 12,5 cm 1x2
15.0137 14 cm 1x2



MICRO-MOSQUITO
15.0139 12,5 cm
kreuzgerieft / cross-serrated
rainures croisées
estriada en forma de cruz
striatura cruciforme

TITANIUM

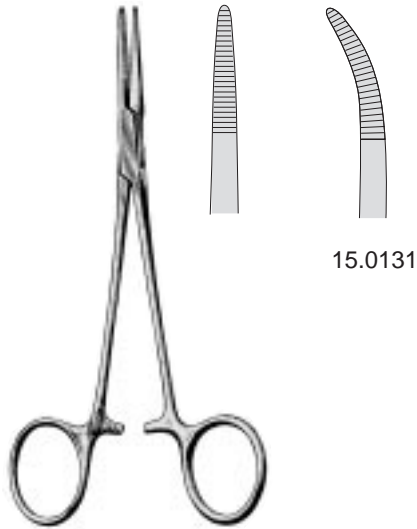

PROVIDENCE-HOSPITAL
 15.0130 14,5 cm



DUNHILL
 15.0180 12,5 cm



KELLY
 15.0200 14 cm
 15.0200T 14 cm



CRILE
 15.0210 14 cm
 15.0210T 14 cm



15.0211
 15.0211T

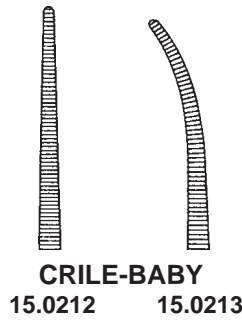

CRILE-BABY
 15.0212 15.0213

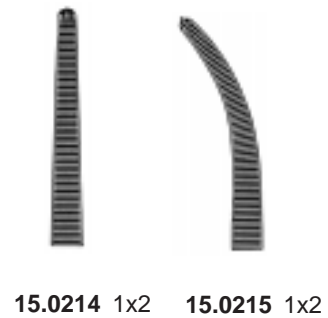

15.0214 1x2 15.0215 1x2



DANDY-MOSQUITO
15.0218 12 cm



DANDY
14,5 cm

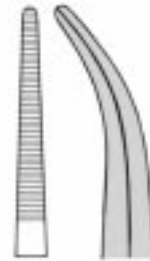

15.0220

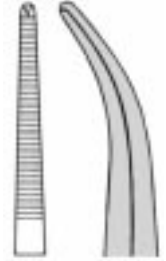

15.0222 1x2



LOVELACE
15,5 cm

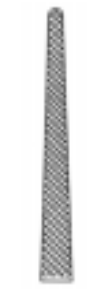

15.0224

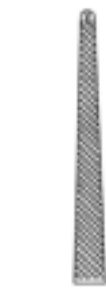

15.0225 1x2



LERICHE
15 cm



15.0230



15.0231



15.0236 1x2



15.0237 1x2



15.0240

15.0241

RANKIN-KELLY
16 cm



15.0251

RANKIN-CRILE
15.0250 16 cm



15.0253
1x2

RANKIN-CRILE
15.0252 16 cm 1x2



15.0260
14 cm

15.0262
16 cm

15.0261
14 cm

15.0263
16 cm

COLLER-CRILE

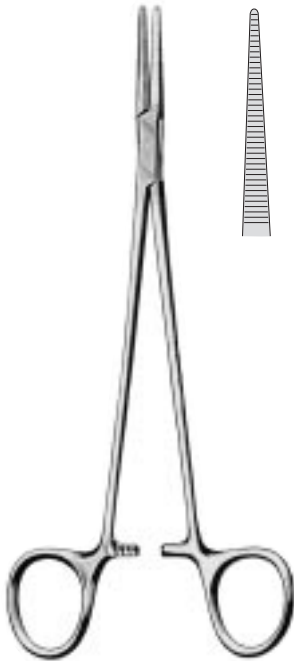

HALSTED

15.0300 18 cm

15.0302 21 cm

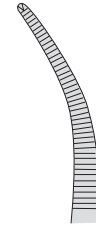
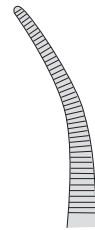

15.0301 18 cm

15.0303 21 cm

15.0306 18 cm 1x2

15.0308 21 cm 1x2

15.0307 18 cm 1x2

15.0309 21 cm 1x2



ADSON-BABY

15.0313 14 cm



15.0315

18 cm



ADSON

15.0310 18,5 cm

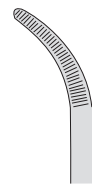

15.0311

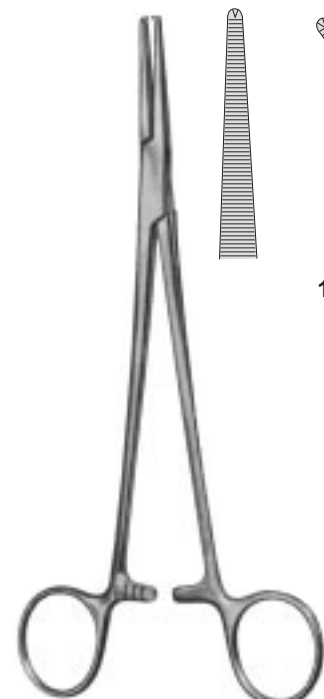

ADSON

15.0316 18,5 cm 1x2

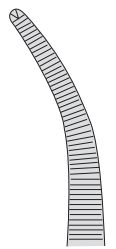

15.0317 1x2



HEISS
 15.0320 20 cm



15.0321 15.0323 15.0324 15.0325
 1x2 1x2



FUCHSIG
 15.0331 18,5 cm



NISSEN
 15.0335 19 cm

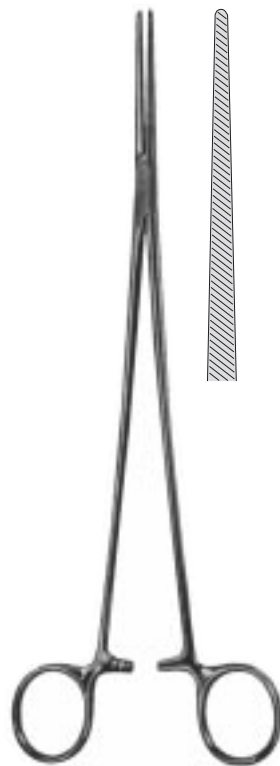

BENGOLEA
 15.0360 20 cm
 15.0362 26 cm

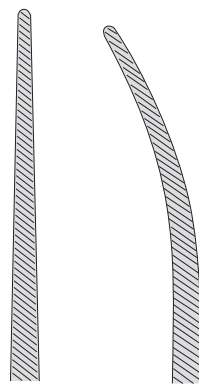

15.0361 20 cm
 15.0363 26 cm

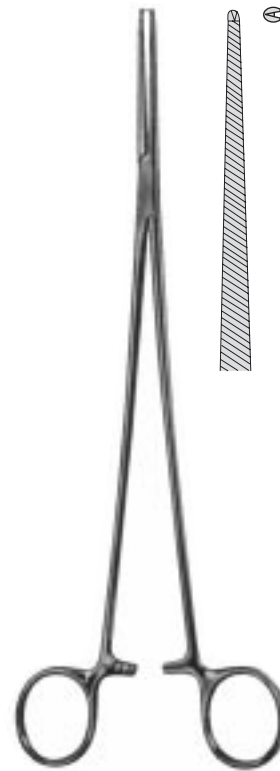

BENGOLEA
 15.0364 20 cm 1x2
 15.0366 26 cm 1x2

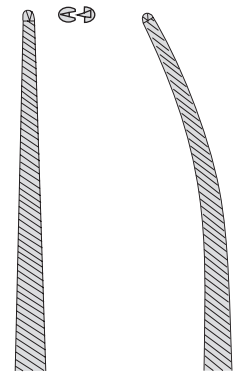

15.0365 20 cm 1x2
 15.0367 26 cm 1x2



BRIDGE
15.0392 28 cm



15.0393
28 cm

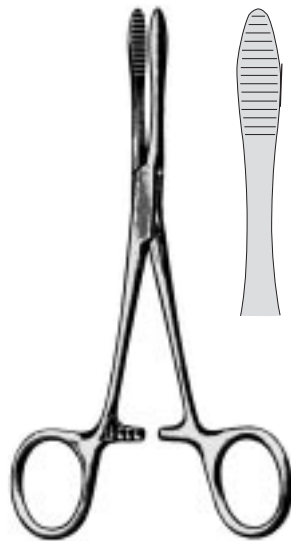

PEAN
15.0404 12,5 cm
15.0406 14,5 cm
15.0408 16 cm



SPENCER-WELLS
15.0410 13 cm
15.0412 14 cm
15.0414 15 cm
15.0416 18 cm
15.0418 20 cm

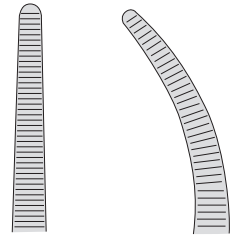

SPENCER-WELLS
15.0411 13 cm
15.0413 14 cm
15.0415 15 cm
15.0417 18 cm
15.0419 20 cm



ROCH-CARMALT
15.0430 16 cm
15.0432 20 cm

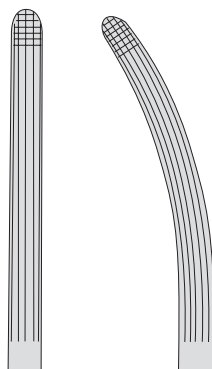

15.0431 16 cm
15.0433 20 cm

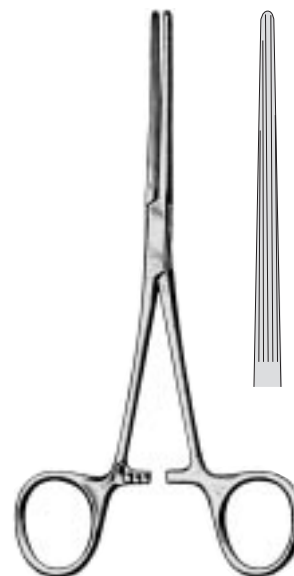

BAINBRIDGE
15.1320 15,5 cm
15.1322 18,0 cm

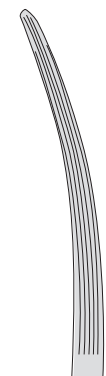

15.1321 15,5 cm
15.1323 18,0 cm

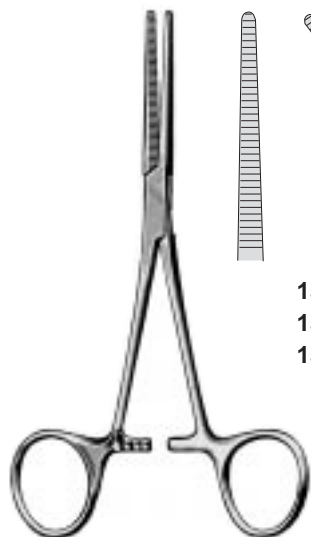

- 15.0451 13 cm
- 15.0453 14 cm
- 15.0455 16 cm

PEAN-FINO

- 15.0450 13 cm
- 15.0452 14 cm
- 15.0454 16 cm



- 15.0459 13 cm
- 15.0461 14 cm
- 15.0463 16 cm
- 15.0465 18 cm
- 15.0467 20 cm
- 15.0469 22 cm
- 15.0471 24 cm
- 15.0473 26 cm
- 15.0477 30 cm

ROCHESTER-PEAN

- 15.0458 13 cm
- 15.0460 14 cm
- 15.0462 16 cm
- 15.0464 18 cm
- 15.0466 20 cm
- 15.0468 22 cm
- 15.0470 24 cm
- 15.0472 26 cm
- 15.0476 30 cm



15.0481

ROBERTS

- 15.0480 22 cm



OLIVECRONA

15.0482
18 cm

15.0484
20 cm

15.0486
24 cm



CRAFOORD

15.0492
18 cm

15.0493
20 cm

15.0494
24 cm



CRAFOORD-SELLORS
24 cm

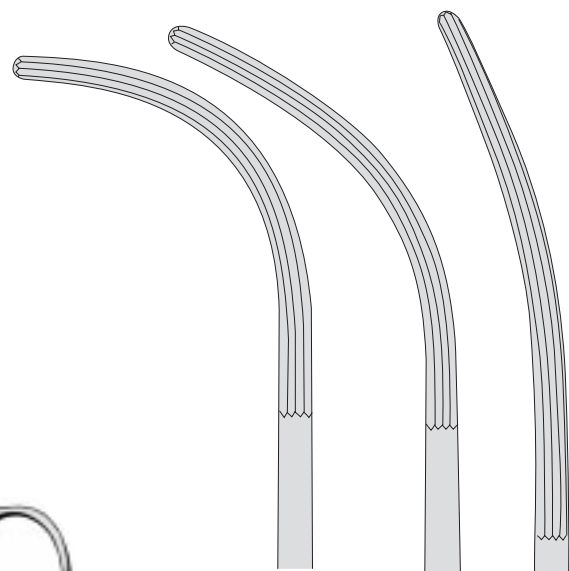

15.0495

15.0496

15.0497



SAROT
 15.0500 24 cm



15.0501



ZENKER
 15.0521 29,5 cm

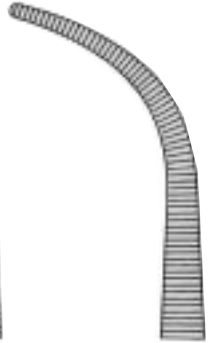
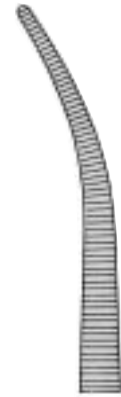

15.0523



KELLY



15.0531
 19 cm

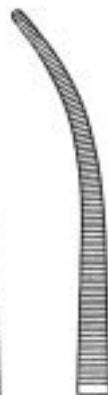

15.0532
 22 cm



15.0533
 24 cm



15.0534
 19 cm



15.0535
 22 cm



15.0536
 24 cm



15.0537
 19 cm



15.0538
 22 cm

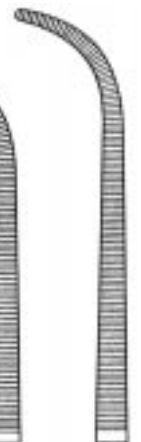

15.0539
 24 cm

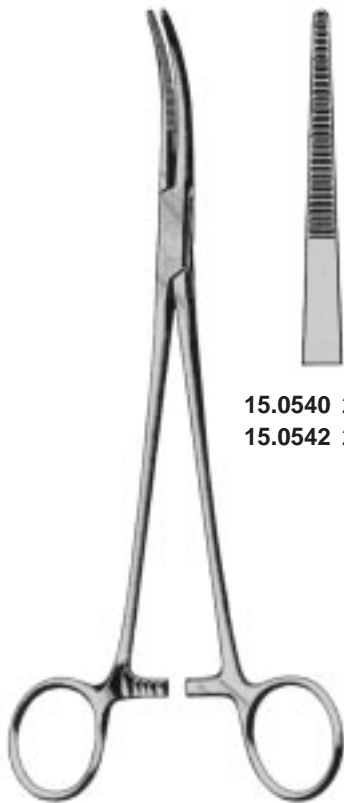

TOENNIS

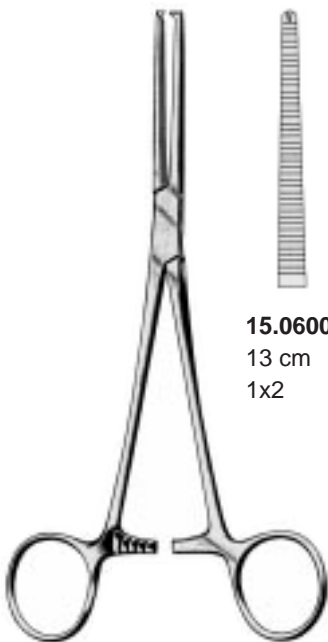
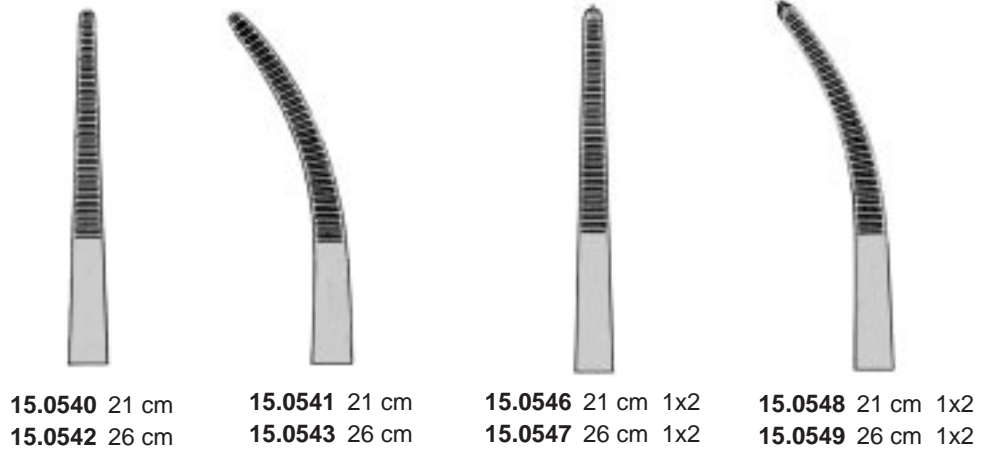

KOCHER

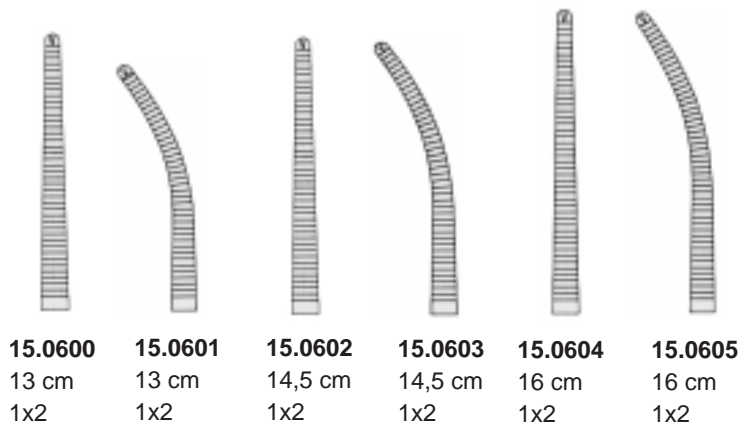

KOCHER-FINO

15.0606 14 cm
15.0608 16 cm

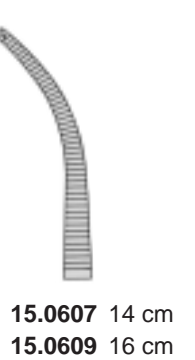



ROCHESTER-OCHSNER

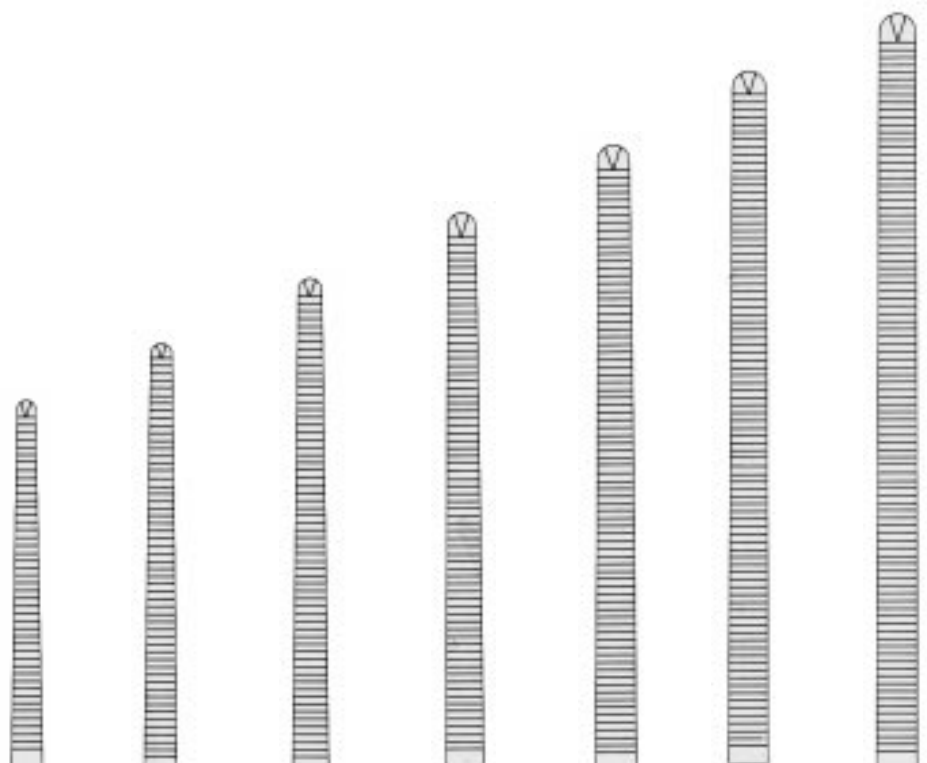

15.0620 16 cm 1x2	15.0622 18 cm 1x2	15.0624 20 cm 1x2	15.0626 22 cm 1x2	15.0628 24 cm 1x2	15.0630 26 cm 1x2	15.0632 30 cm 1x2
--------------------------------	--------------------------------	--------------------------------	--------------------------------	--------------------------------	--------------------------------	--------------------------------

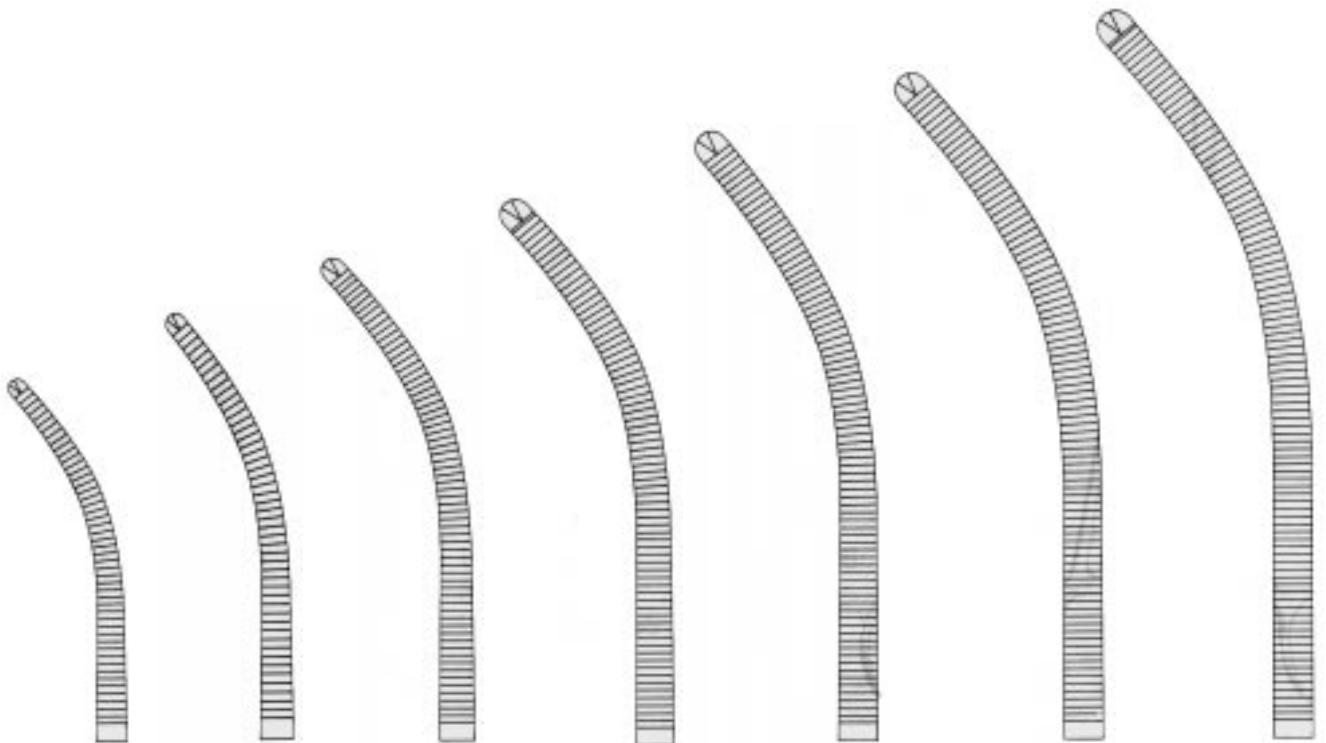

15.0621 16 cm 1x2	15.0623 18 cm 1x2	15.0625 20 cm 1x2	15.0627 22 cm 1x2	15.0629 24 cm 1x2	15.0631 26 cm 1x2	15.0633 30 cm 1x2
--------------------------------	--------------------------------	--------------------------------	--------------------------------	--------------------------------	--------------------------------	--------------------------------



MIXTER-O'SHAUGHNESSY

15.0701 15 cm

15.0703 19 cm



OVERHOLT-BABY

15.0720 14 cm

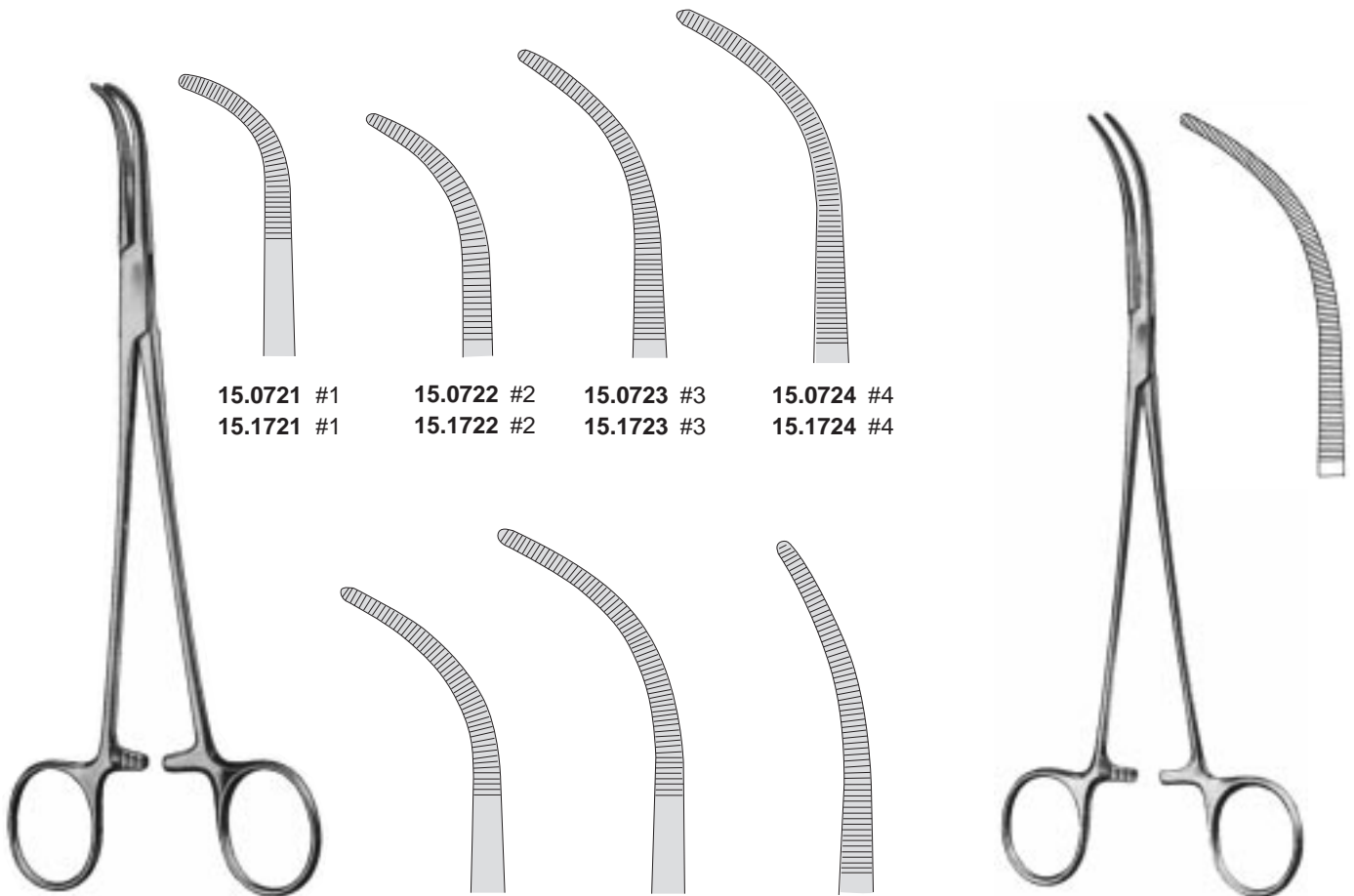

15.0721 #1

15.1721 #1

15.0722 #2

15.1722 #2

15.0723 #3

15.1723 #3

15.0724 #4

15.1724 #4

15.0725 #5

15.1725 #5

15.0726 #6

15.1726 #6

15.0727 #7

15.1727 #7

OVERHOLT-GEISSENDOERFER

15.0721-15.0727 21 cm

15.1721-15.1727 27 cm

OVERHOLT-MIXTER

15.0729 21 cm

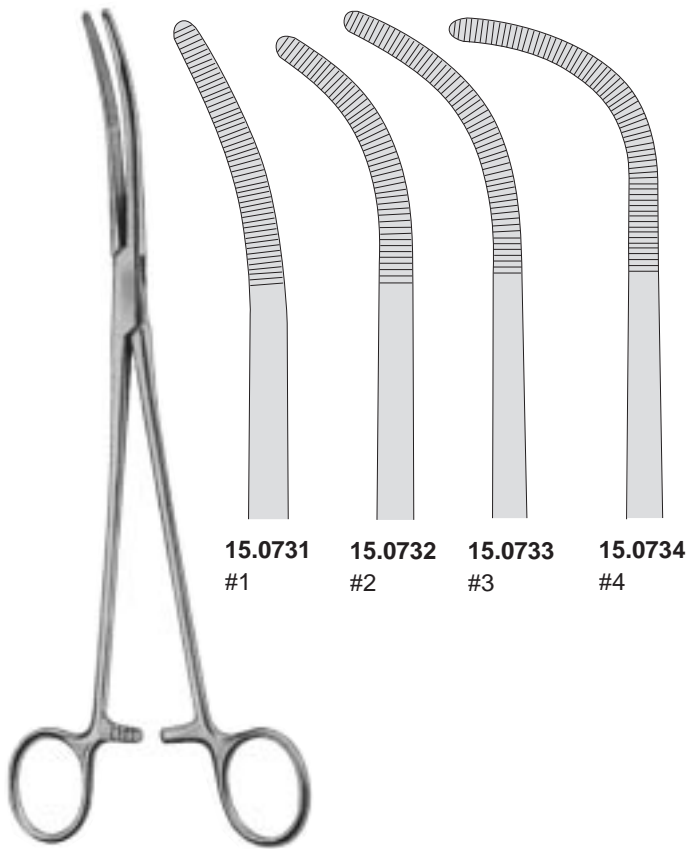

15.0731 #1
 15.0732 #2
 15.0733 #3
 15.0734 #4

RUMEL
 23 cm



15.0741 20 cm
 15.0743 24 cm
 15.0745 28 cm

KANTROWITZ

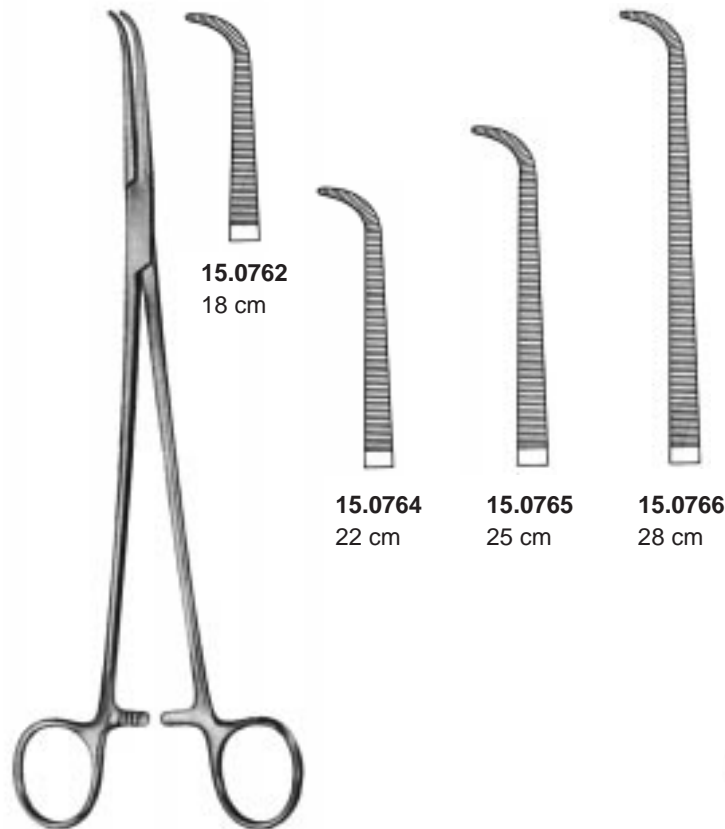

15.0762 18 cm

15.0764 22 cm

15.0765 25 cm

15.0766 28 cm

GEMINI-MINI

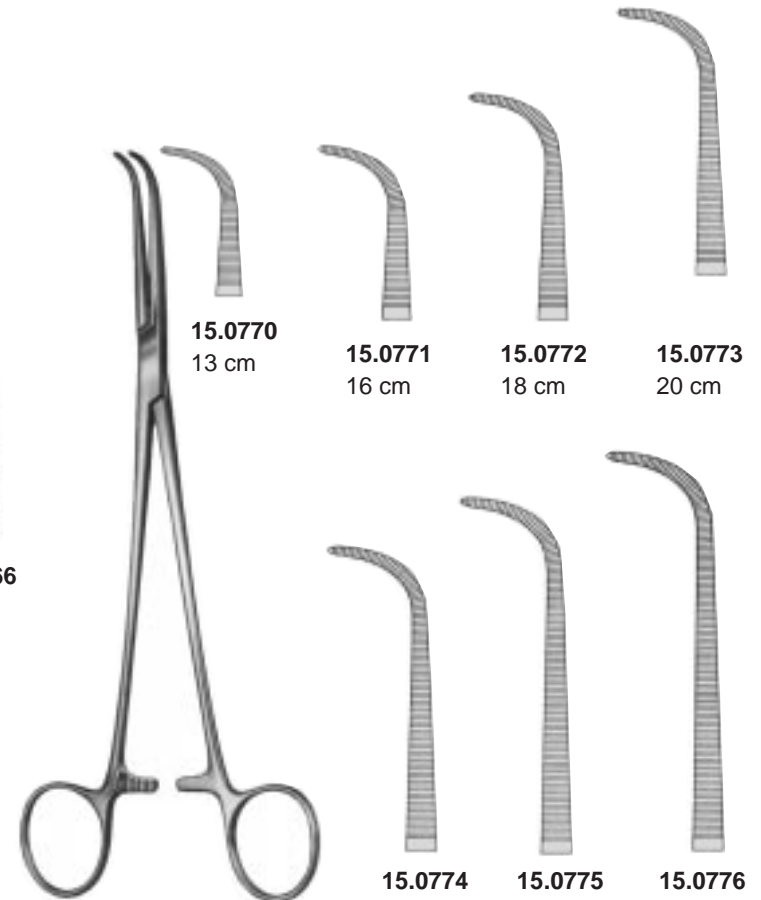

15.0770 13 cm

15.0771 16 cm

15.0772 18 cm

15.0773 20 cm

15.0774 23 cm

15.0775 25 cm

15.0776 28 cm

GEMINI



WIKSTROEM
15.0780 21 cm
15.0782 24 cm



LAWRENCE
15.0784 28 cm



MEEKER
15.0786 28 cm



MIXTER-BABY
15.0801 14,5 cm



MIXTER-BABY
15.0803 18 cm

15.0802



MIXTER
 15.0807 22 cm



MIXTER
 15.0809 23 cm



MIXTER

15.0811
 16 cm

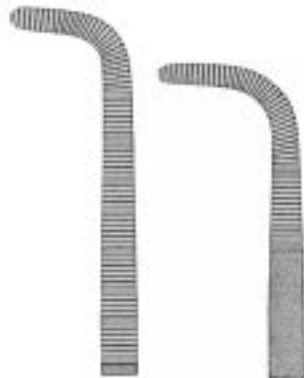

15.0813
 19 cm



15.0817
 23 cm



MIXTER

15.0831
 22 cm

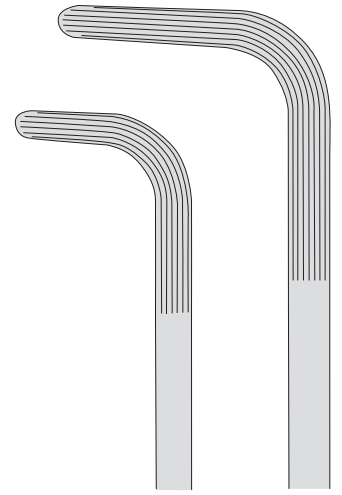

15.0833
 25 cm

15.0835
 28 cm



SCHNIDT
34.0303
19 cm



SAWTELL
34.0305
19 cm



SCHNIDT
34.0307
19 cm



SAWTELL
34.0309
19 cm



NEGUS
19 cm



34.0311



34.0313



WHITE
34.0321 18 cm
34.0323 23 cm

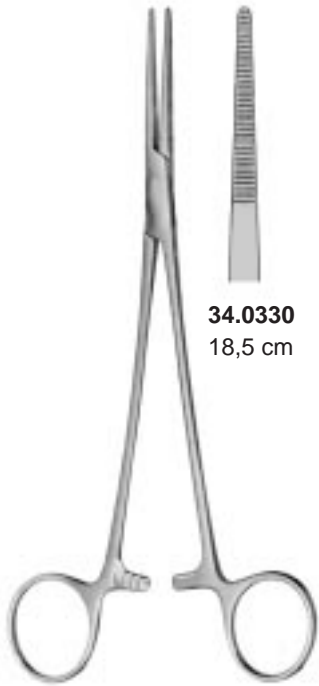

34.0330
18,5 cm

BIRKETT



34.0331
18,5 cm



BALLENGER
34.0333
21,5 cm



BLOHMKE
34.0335
20 cm



MARSCHIK
34.0350
22 cm



COLVER
19 cm



34.0327



34.0329



HARRINGTON
 40.0701
 30,5 cm



HARRINGTON
 40.0702
 29,5 cm



40.0713
 Zähne links
 teeth on left
 dents à gauche
 dientes a la izquierda
 denti sinistro



40.0714
 Zähne rechts
 teeth on right
 dents à droite
 dientes a la derecha
 denti destro



SAROT
 23 cm



FINOCCHIETTO
 40.0720
 24 cm



40.0730

PRICE-THOMAS
22 cm



40.0731
Zähne links
teeth on left
dents à gauche
dientes a la izquierda
denti sinistro

40.0732
Zähne rechts
teeth on right
dents à droite
dientes a la derecha
denti destro

PRICE-THOMAS
22 cm



BRONCHUS
23 cm



40.0740
60 mm



40.0742
80 mm



LOVELACE
40.0750
20 cm



LOVELACE
40.0751
20 cm



SEMB



40.0761
24 cm #1



40.0763
24 cm #2



SATINSKY
40.0900
15 cm

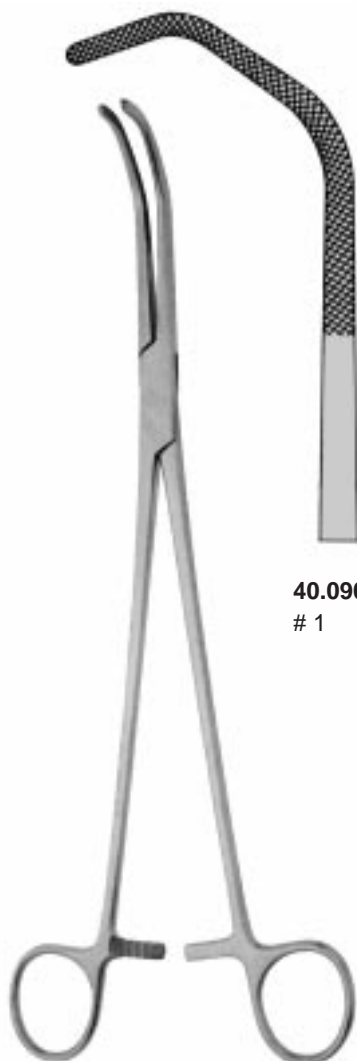

40.0902
1

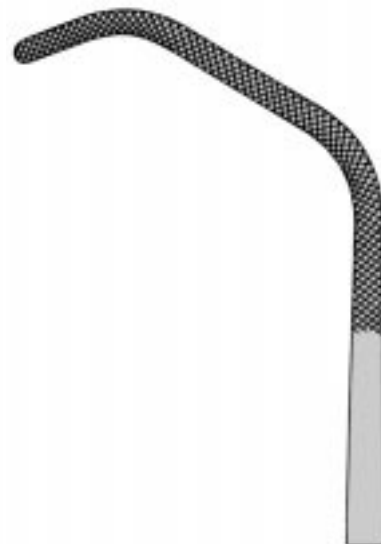

40.0904
2



CHAPUT
 15.1200 12 cm



TUFFIER
 15.1204 13 cm

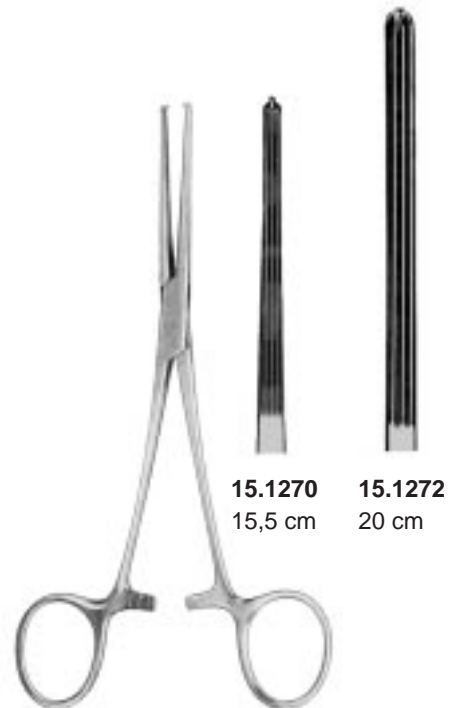

15.1270 15,5 cm
15.1272 20 cm

ALLEN-KOCHER



PENNINGTON
 15.1300 15 cm
 15.1302 20 cm



ALLIS-BABY
 48.0004 13 cm, 4 x 5
 48.0006 14 cm, 4 x 5



48.0010
 15 cm, 4 x 5

48.0011
 15 cm, 5 x 6

48.0014
 19 cm, 5 x 6

48.0016
 25 cm, 5 x 6

ALLIS

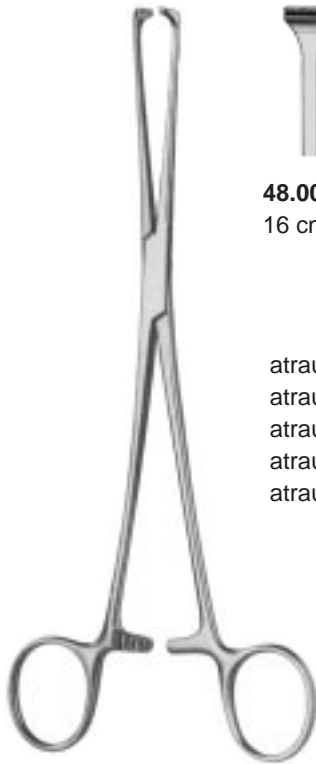

ALLIS

48.0020
16 cm

atraumatisch
 atraumatic
 atraumatique
 atraumática
 atraumatiche

48.0024
20 cm

48.0028
25 cm

48.0029
30 cm



ALLIS-ADAIR
48.0030 15,5 cm



JUDD-ALLIS
48.0032 15 cm
48.0034 19 cm
3 x 4



LITTLEWOOD
48.0035 19 cm
2 x 3



BOYS-ALLIS
48.0036 15 cm



THOMS-ALLIS
48.0038 20 cm
6 x 7



LOCKWOOD
 48.0040 19,5 cm



OMBREDANNE
 48.0050 13,5 cm



WILLIAMS
 48.0045 16,5 cm



BABCOCK



48.0062
 16 cm



48.0064
 18 cm



48.0066
 20 cm



48.0068
 24 cm



BABCOCK



48.0072
16 cm



48.0076
20 cm

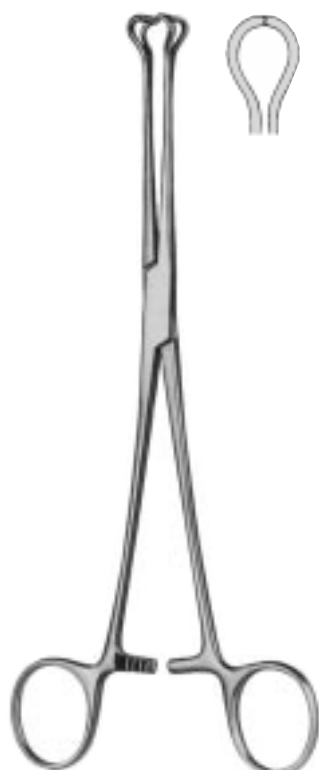

BABCOCK-DEBAKEY



48.0082
16 cm



48.0086
20 cm



48.0088
23 cm



COLLIN
48.0089
 14 cm



DUVAL



48.0090
 18 cm / 14 mm
48.0092
 20 cm / 14 mm



48.0094
 20 cm / 25 mm
48.0098
 23 cm / 25 mm



48.0094 AT
 20 cm / 20 mm
48.0098 AT
 23 cm / 25 mm

atraumatisch
 atraumatic
 atraumatique
 atraumática
 atraumatiche



DUVAL



48.0099
 20 cm / 15 mm





15.1580
25 cm



DEBAKEY



15.1582
27 cm



PRATT
15.1350 15 cm



KOCHER-BABY
13 cm

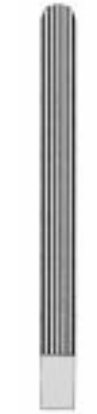

48.0100



48.0101



DOYEN
18 cm



48.0102



48.0103



DOYEN



48.0104 21 cm
48.0106 23 cm



48.0105 21 cm
48.0107 23 cm

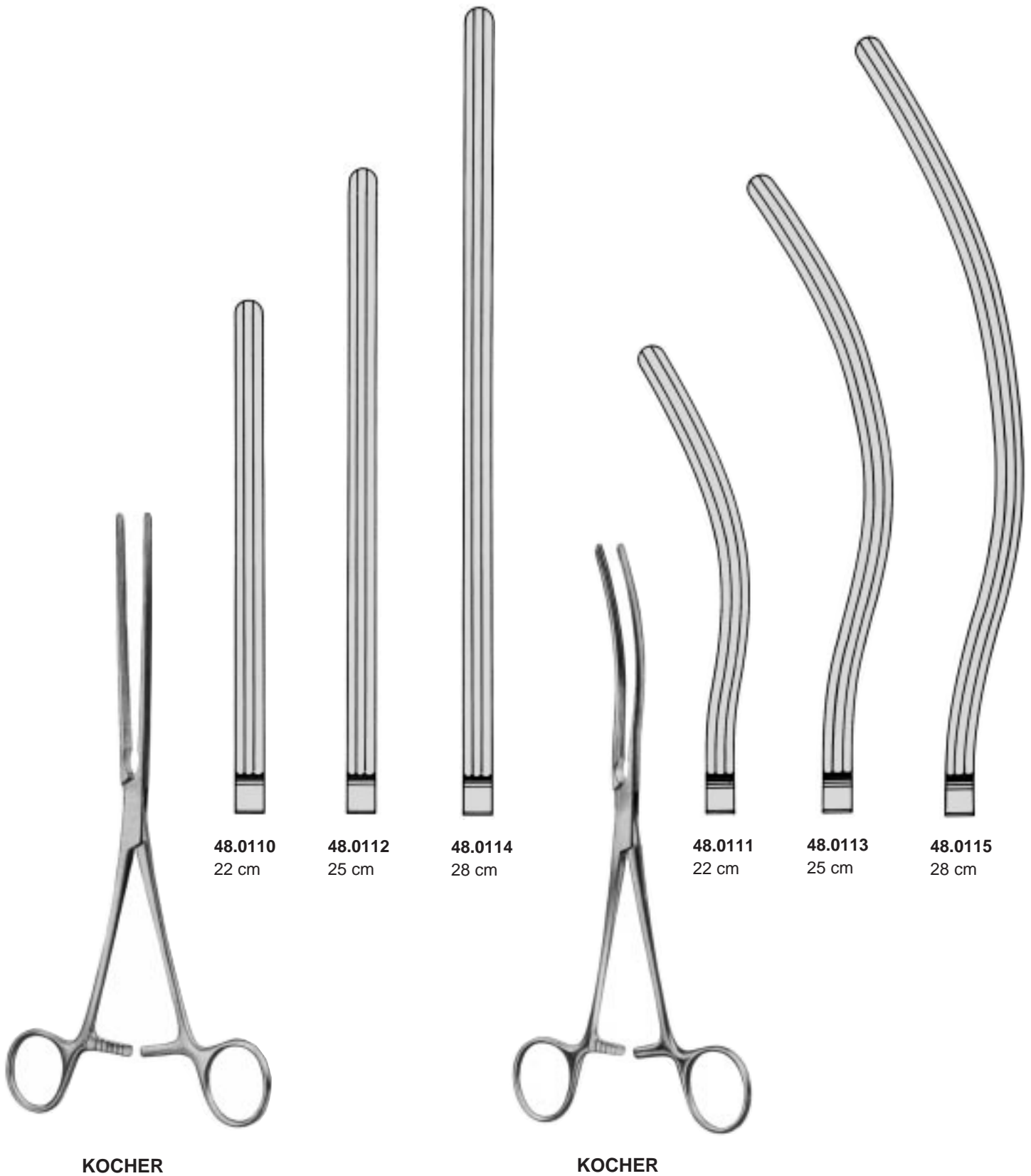

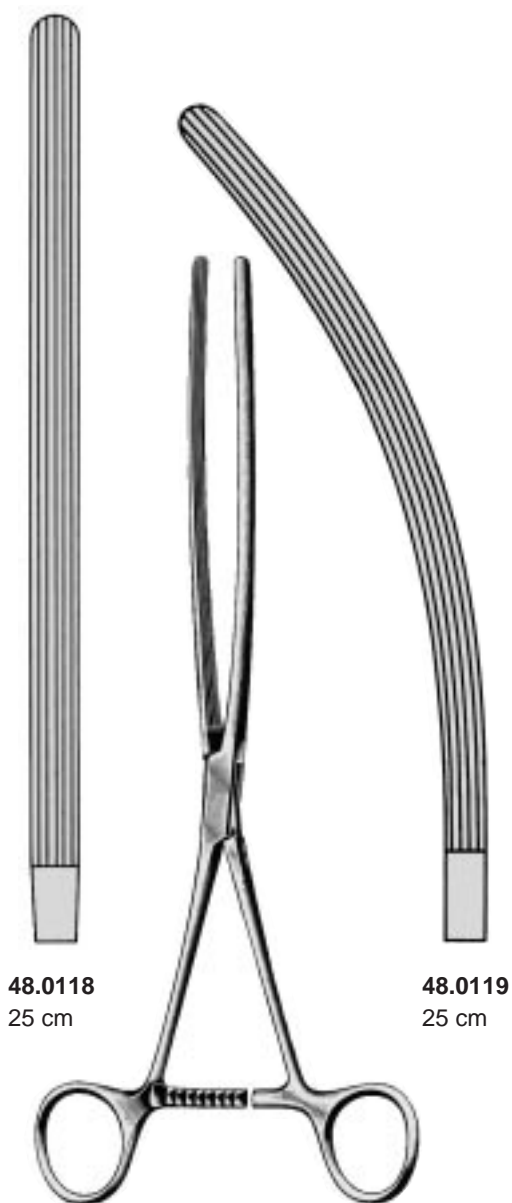

MAYO-ROBSON

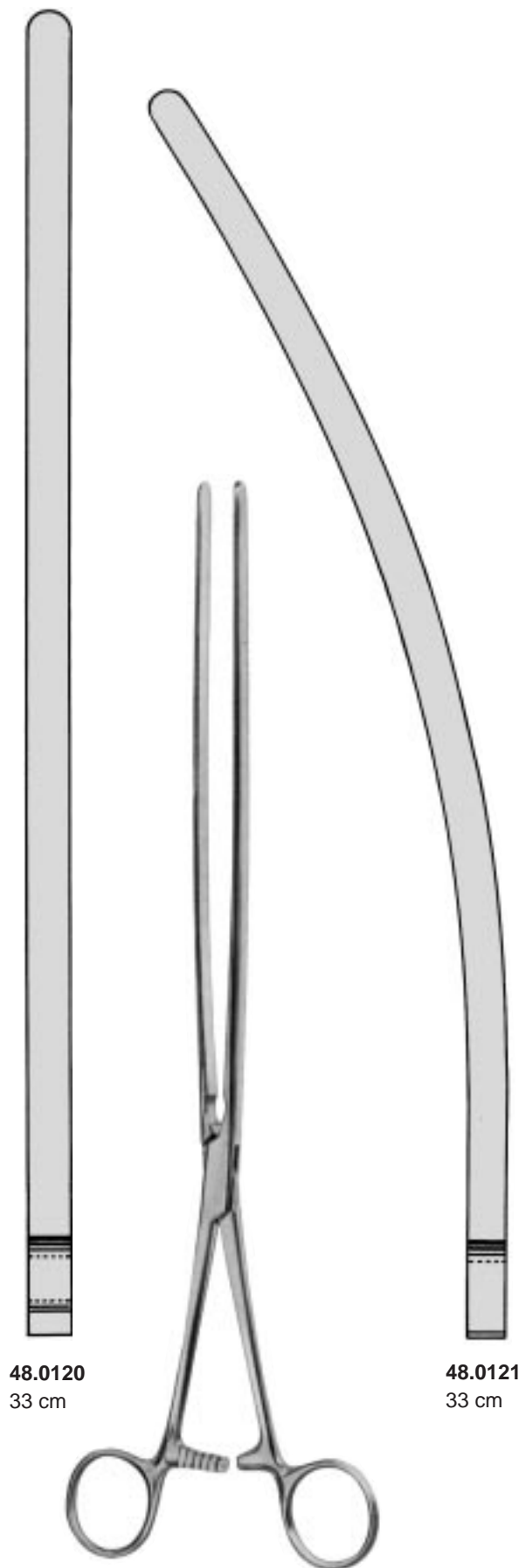

SCUDDER



NUSSBAUM
25 cm

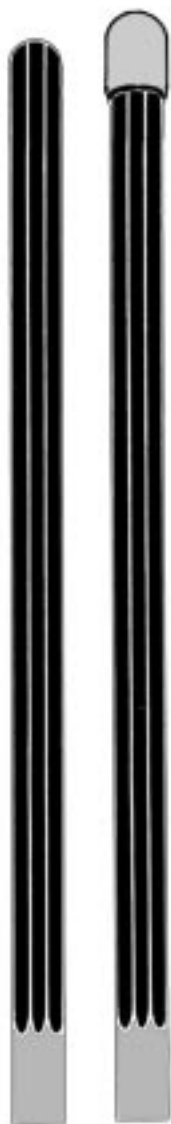

48.0122



48.0123



BRUNNER
48.0125 23 cm



48.0130
26,5 cm / 30 mm



48.0131
26,5 cm / 60 mm



48.0132
26,5 cm / 75 mm



FEHLAND
48.0126 24 cm



BEST

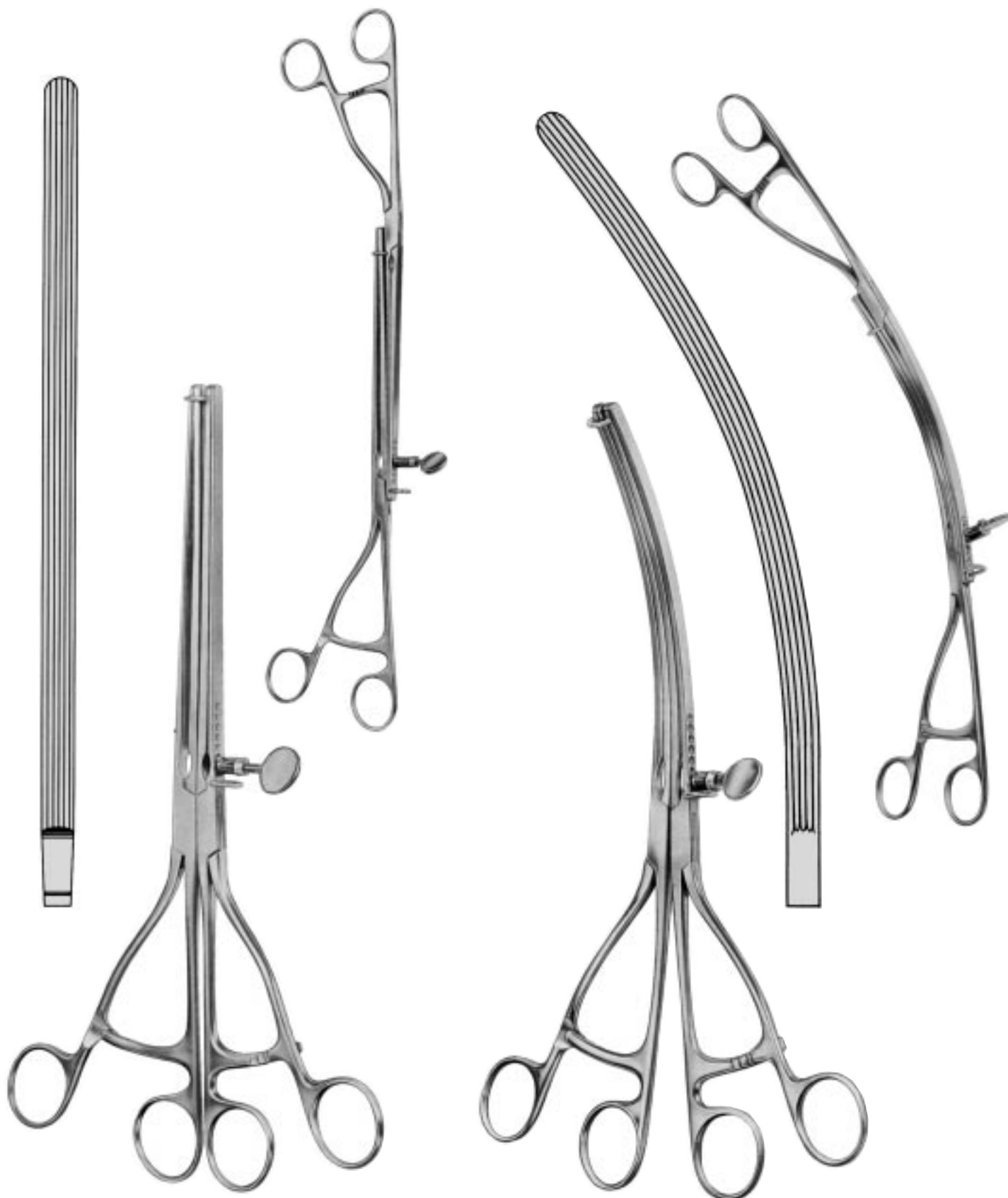

LANE
48.0140 30 cm

LANE
48.0141 30 cm

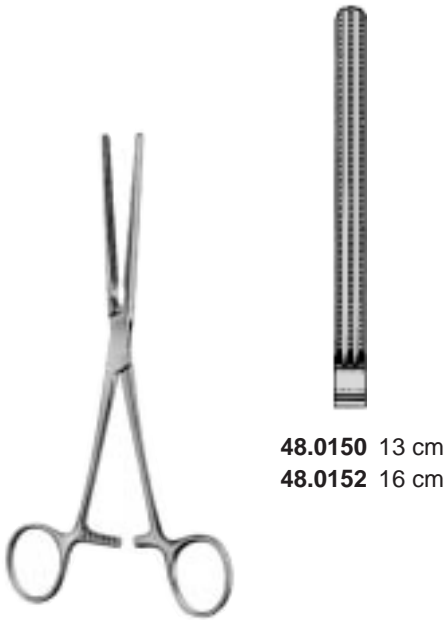

48.0150 13 cm
 48.0152 16 cm

DOYEN-DEBAKEY



48.0151 13 cm
 48.0153 16 cm

DOYEN-DEBAKEY

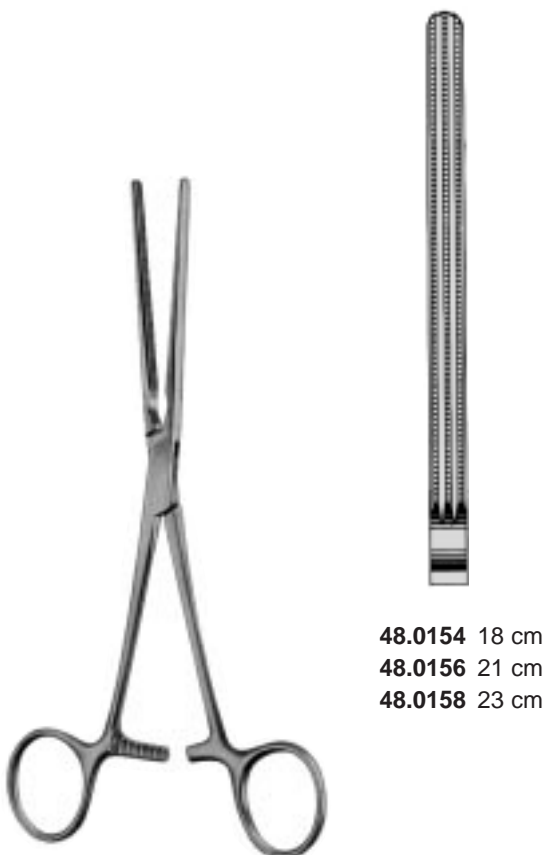

48.0154 18 cm
 48.0156 21 cm
 48.0158 23 cm

DOYEN-DEBAKEY



48.0155 18 cm
 48.0157 21 cm
 48.0159 23 cm

DOYEN-DEBAKEY



KOCHER-DEBAKEY

48.0160 22 cm

48.0162 25 cm

48.0164 28 cm



KOCHER-DEBAKEY

48.0161 22 cm

48.0163 25 cm

48.0165 28 cm



HAYES-DEBAKEY



48.0170
26 cm / 55 mm

48.0172
28 cm / 85 mm



FEHLANT-DEBAKEY
48.0180 24 cm

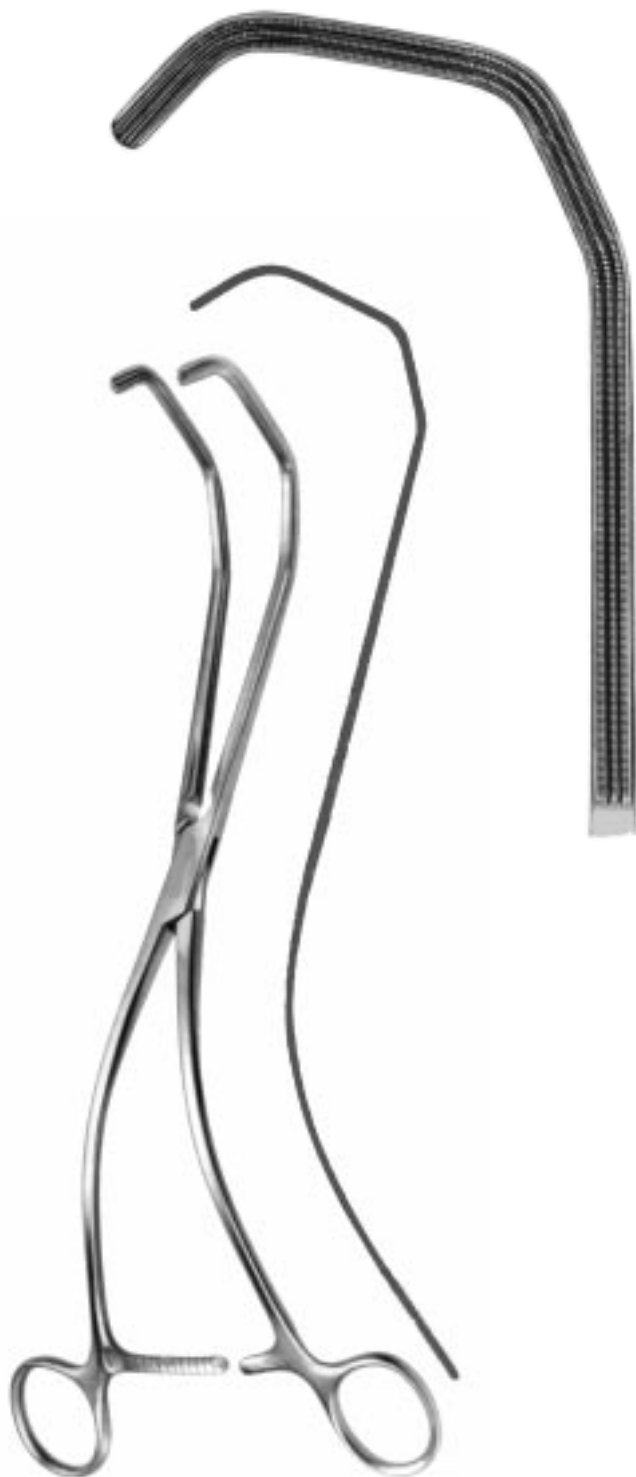

KERSTING
48.0184
31 cm

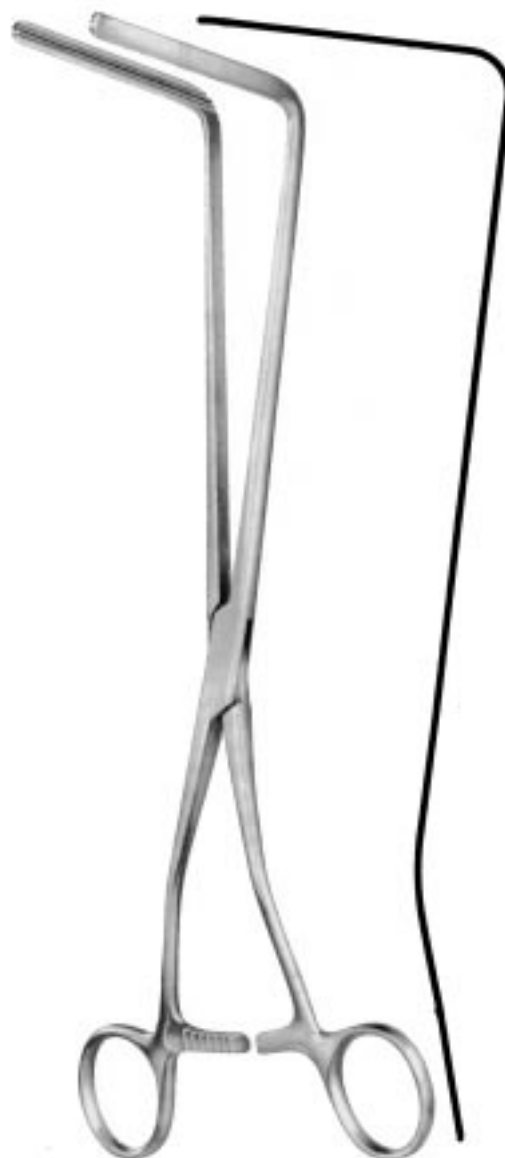

RESANO
48.0186
30 cm



SCUDDER-DEBAKEY
48.0190
33 cm

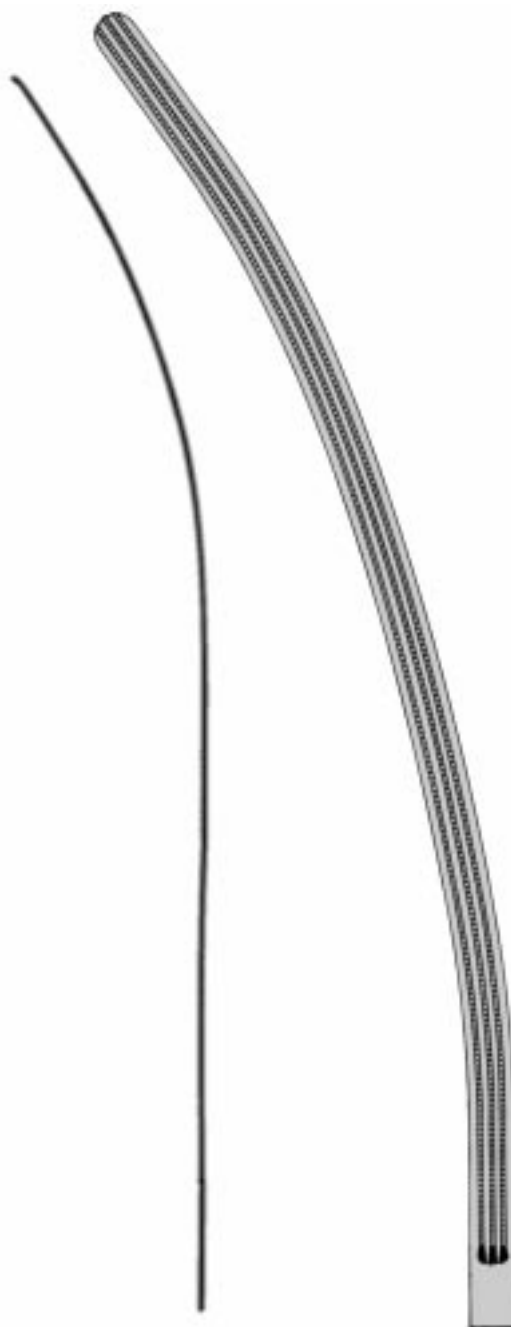

SCUDDER-DEBAKEY
48.0191
33 cm



48.0200
25 cm 0°



48.0204
28 cm 0°



48.0201
25 cm 15°



48.0205
28 cm 15°

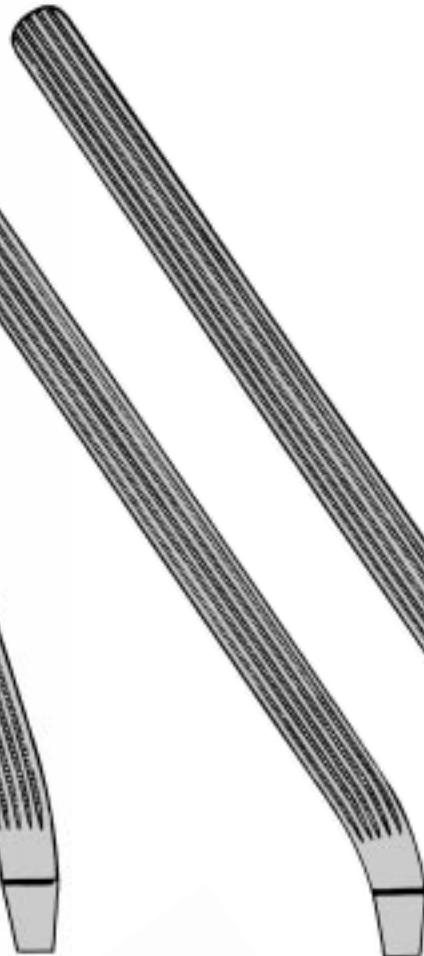

48.0203
25 cm 30°



48.0207
28 cm 30°

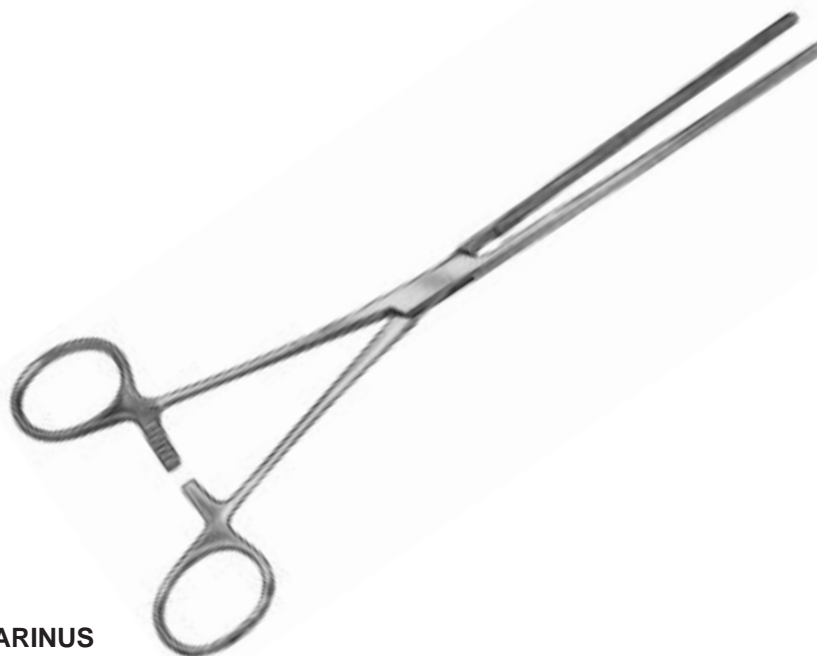

MARINUS



BUIE
48.0300 21 cm



LLOYD-DAVIES
48.0350 31,5 cm



FERGUSSON

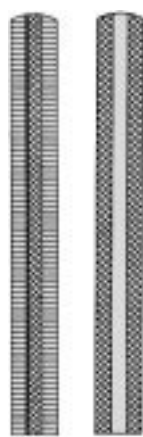

48.0312 20 cm

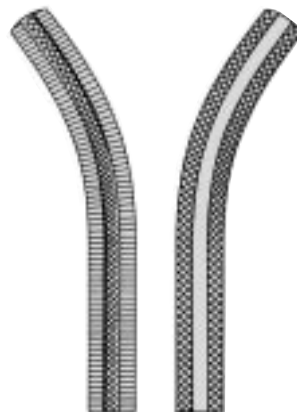

48.0313 20 cm



LAHEY
15.0841 19 cm
15.0843 23 cm



MOYNIHAN
15.0901 23 cm
15.0903 24 cm



DESJARDIN
15.0911 21 cm



DESJARDIN
15.0913 21 cm



LOWER
15.0931 18 cm



JOHNS-HOPKINS
15.0941 20 cm



MIXTER
15.1015 22 cm



GRAY
15.1031 22 cm #1



15.1033
23 cm #2



GRAY
15.1035 22 cm #1



15.1037
23 cm #2



BLAKE
20 cm



50.0300



50.0301



DESJARDINS
23 cm



50.0311
#1



50.0313
#2



DESJARDINS



50.0315
24 cm



50.0317
22,5 cm



MAYO-BLAKE
50.0320
20 cm



MAYO-BLAKE
50.0321
20 cm



MIXTER
50.0325
22 cm



DOYEN
50.0330
20 cm



MAYO-GUYON
15.1930 23 cm



GUYON

15.1931
20 cm



15.1933
22 cm



15.1935
24 cm



GUYON
15.1937 23 cm



STILLE
15.1940 23 cm



HERRICK
15.1960 23 cm

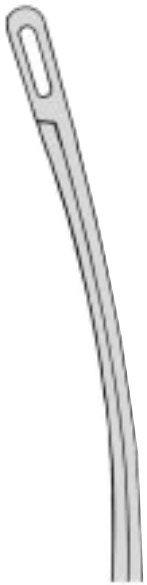

50.0340
 23 cm #1



50.0342
 21 cm #2



50.0344
 19 cm #3



1



2



50.0346
 18 cm #4

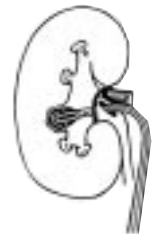

3

RANDALL

50.0347

Satz #1-4 / Set #1-4 /

Jeu #1-4 / Juego #1-4 / Serie di #1-4



RANDALL

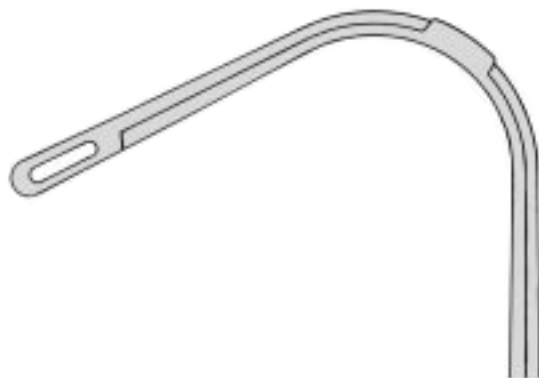

50.0348
 19 cm #5



4



50.0350
 19 cm #6



5 / 6



URO

24 cm

Ureterzangen
Ureter Forceps
Pincés pour urètre
Pinzas para uréter
Pinze per uretere



50.0401
1



50.0402
2



DARTIGUES

55.1520

27 cm

Nierenfaßzange
Kidney elevating forceps
Hystérolabe
Pinza para sostener el riñón
Pinze per afferare il rene

Prostata-Fasszange
Prostatic grasping forceps
Pince à saisir la prostate
Pinza para coger prostata
Pinza per afferare la prostata



YOUNG
51.0004
20 cm

Samenstrang-Fixierklemme
Spermatic cord fixation clamp
Pince pour fixer le canal déférent
Pinza-fixajion canal espermatica
Pinza per fissare il tronco spermatico



SPERMATIC
51.0040
14,5 cm

Ureterklemmen
Ureter clamps
Pinces à urètere
Pinzas clamps para ureter
Pinze per uretere



51.0042
21 cm #2

LURZ
51.0041
21 cm #1



WERTHEIM
 15.2125
 24 cm 1x2

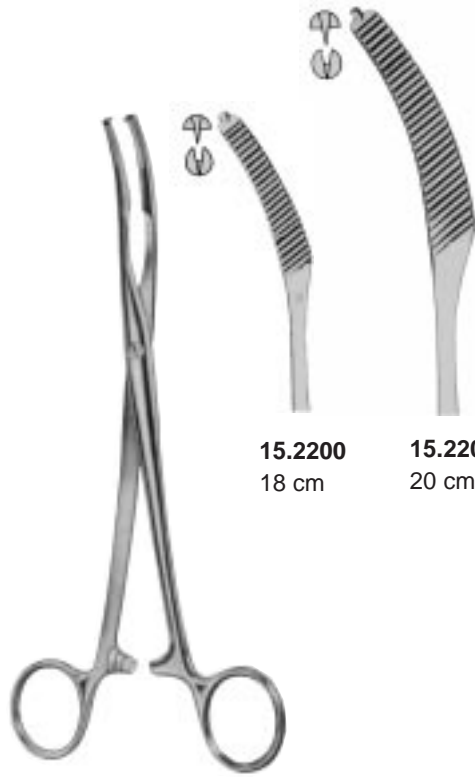

15.2200
 18 cm

15.2202
 20 cm



15.2209
 20 cm

15.2211
 20 cm



MIKULICZ-BABY
 15.2215 14 cm



15.2221

15.2223

FAURE
 20 cm



FAURE
 15.2225 25 cm



PHANEUF

15.2300
21,5 cm



15.2301
21,5 cm

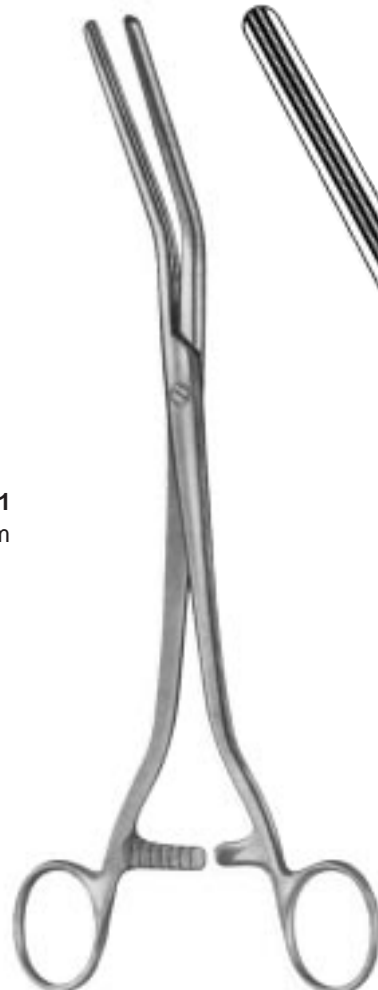
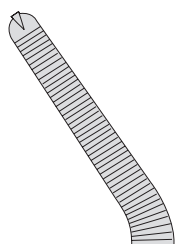

DICK

Druckklemmen
Pressure Clamps
Pinces à pression
Pinzas de presión
Pinze de pressione

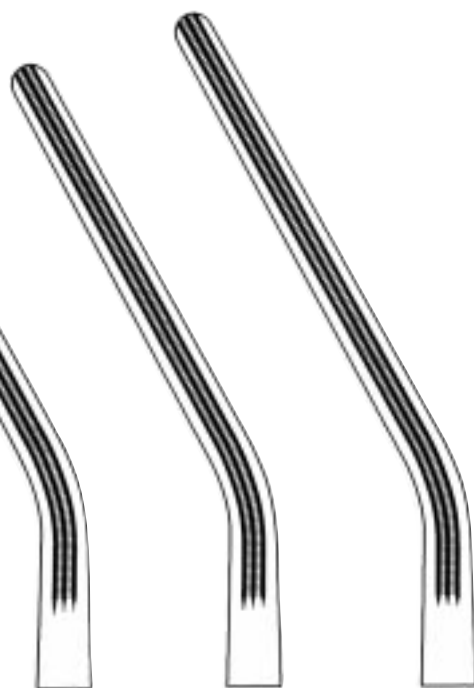

15.2230
25 cm

15.2232
26 cm

15.2234
27 cm



HEANEY-KANTOR

15.2311 20 cm
15.2313 23 cm



HEANEY-REZEK

15.2314 23 cm



HEANEY

15.2315 20 cm
15.2317 23 cm



WERTHEIM

15.2321 25 cm



**SECOND-
LANDAU**

15.2324
24 cm



SECOND

15.2325
24 cm



WERTHEIM-CULLEN
15.2340 21,5 cm



WERTHEIM-ATRAUMA
15.2344 21 cm

atraumatisch
atraumatic
atraumatique
atraumática
atraumatiche



15.2345
22 cm
1x2

WERTHEIM



15.2347
22 cm
1x2

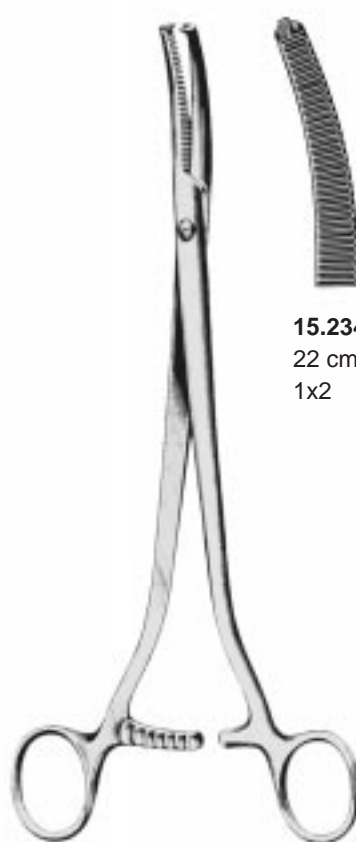

15.2348
22 cm
1x2

WERTHEIM



15.2349
22 cm
1x2



15.2360
22 cm



15.2361
22 cm



15.2362
21 cm



15.2363
20 cm



WERTHEIM-DEBAKEY



15.2365
25 cm



15.2366
25 cm



15.2367
25 cm



15.2368
24 cm

HAKENZANGEN

TENACULUM FORCEPS

PINCES POUR ABAISSEMENT DU COL UTERIN

PINZAS PARA COGER EL CUELLO DEL UTERO

PINZE PER ABBASSARE EL COLLO DELL'UTERO

PRO-MED



BARRETT
55.0930
18 cm



STAUDE-MOORE
55.0932
17 cm



BRAUN
55.0934
25 cm



CZERNY
55.0936
21 cm



ADAIR
55.0938
19 cm



SCHROEDER
55.0940
25 cm



POZZI
55.0944
25 cm



DUPLAY
55.0947
28 cm



HULKA
55.0948
29 cm



HULKA-KENWICK
55.0949
29 cm



SKENE
55.0951
24 cm



TIEMANN
55.0956
22 cm



55.0962
2 x 2



55.0963
2 x 2



SCHROEDER
24 cm

HAKENZANGEN

TENACULUM FORCEPS

PINCES POUR ABAISSEMENT DU COL UTERIN

PINZAS PARA COGER EL CUELLO DEL UTERO

PINZE PER ABBASSARE EL COLLO DELL'UTERO

PRO-MED



55.0971

HENROTIN

55.0965

21 cm 2 x 3

PRATT

55.0968

28 cm

JACOBS

55.0970

21 cm



TEALE

55.0973 18 cm 3 x 4

55.0975 23 cm 3 x 4



KÜSTNER

55.0977 25 cm 2 x 3

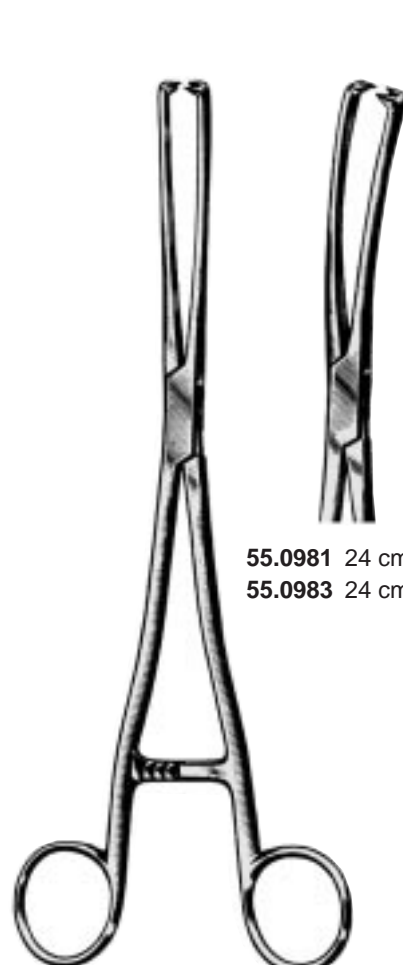

MUSEUX

55.0980 24 cm / 6 mm

55.0982 24 cm / 8 mm

55.0984 24 cm / 10 mm



6 mm

8 mm

10 mm

55.0981 24 cm / 6 mm

55.0983 24 cm / 8 mm



SOMER
55.1500
23 cm



COLLIN
551510
25 cm



COLLIN
55.1511
25 cm



DARTIGUES
55.1520
27 cm

Klemmzange / Uterine Hémostatic Forceps /
Pinze-Clamp utérine / Pinza-Clamp uterina / Pinza-Clamp uterina



GREEN-ARMYTAGE
56.0800 22 cm



GREEN-ARMYTAGE
56.0801 20 cm

Kopfschwartzangen / Scalp flap forceps / Pincés pour le
quir chevelu / Pinzas para pericráneo / Pinze per pericraneio



MARTEL
15.1340 14 cm



WILLET
15.1342 19 cm



GAUSS
56.0805 26 cm

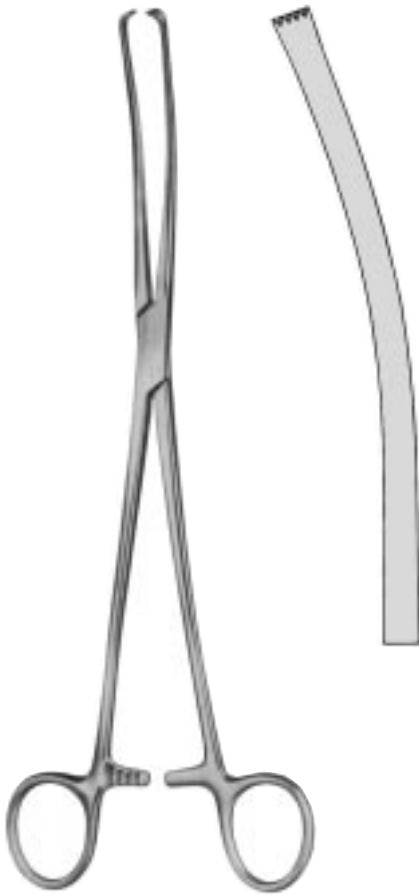

Blasensprenger /
Membrane puncturing forceps /
Pince perce-membrane /
Pinza rompe membrana /
Pinza rompere membrana

IOWA
56.0820 26 cm

Uterus-Polymenzangen / Uterine Polypus Forceps /
Pinces à polypes utérines / Pinzas para pólipos uterinos /
Pinze per polipi uterini



HEYWOOD-SMITH
56.0880 21 cm
56.0882 25 cm



DOYEN
56.0890 20 cm

Uterus-Polymenzangen / Uterine Polypus Forceps /
Pincés à polypes utérines / Pinzas para pólipos uterinos /
Pinze per polipi uterini



NOTO
56.0896 27 cm



BUMM
56.0898 28 cm

Plazentar- und Abortuszangen / Placenta- and Ovum Forceps / Pincers à faux germes /
 Pinzas para aborto y placenta / Pinze per aborto e placenta



KELLY
 56.0900 32 cm

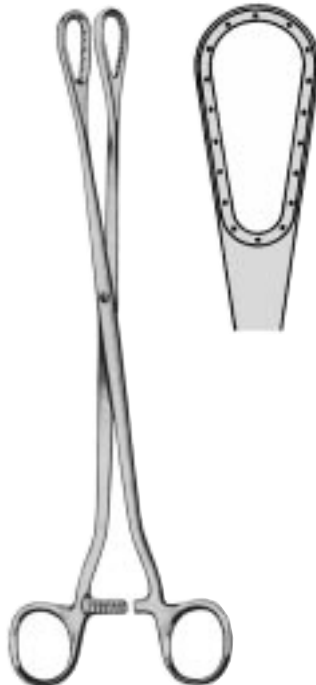

SAENGER
 56.0910 27 cm

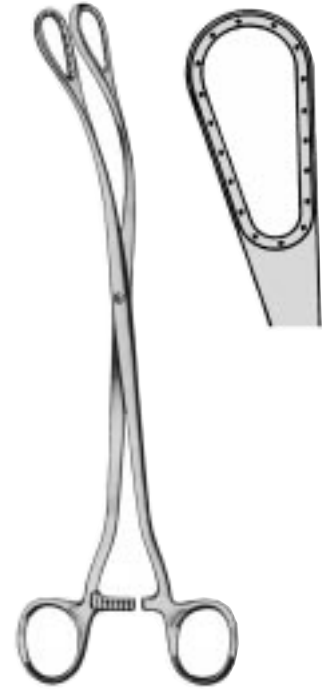

SAENGER
 56.0911 27 cm



WINTER
 29 cm



56.1002
 #2



56.1004
 #3



WINTER
 29 cm



56.1001
 #1



56.1003
 #2



56.1005
 #3

TUCH- UND SCHLAUCHKLEMMEN,
TUPFERZANGEN

TOWEL- AND TUBING CLAMPS,
DRESSING- AND SPONGE FORCEPS

PINCES A CHAMPS ET A TAMPONS,
PINCES PRESSE-TUBES

PINZAS DE CAMPO, PARA TUBOS
Y PARA TAMPONES

PINZE FISSATELI, PINZE SERRATUBI
PINZE PER TAMPONI





JONES
16.0010 5 cm
16.0012 9 cm



SCHAEDEL
16.0031 9 cm



DOYEN
16.0050 18 cm

für Papiertücher
for paper drapes
pour champs en papier
para paños de papel
per fazzoletti di carta

mit Schlauchhalter
with tubeholder
avec clamp porte-tube
con porta-tubo
con porta-tubo



BACKHAUS
16.0100 9 cm
16.0102 11 cm
16.0105 13 cm
16.0106 15 cm



BACKHAUS
16.0107 11 cm
16.0108 13 cm

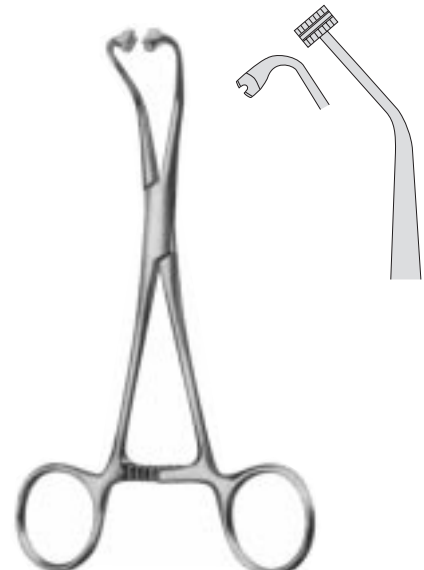

PEERS
16.0112 14,5 cm

für Papierabdeckung / for paper drapes / pour couverture en papier / para paños de papel / per copertura di carta



ROEDER
16.0115 13 cm
16.0116 15 cm

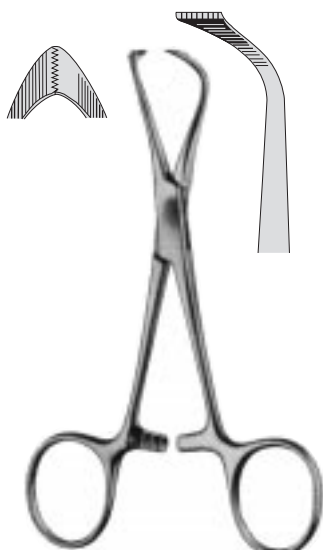

LORNA
16.0120 10 cm
16.0125 13 cm



BALL&SOCKET
16.0132 11 cm
16.0135 13 cm



TOHOKU
16.0140 10 cm
16.0145 13 cm



LANE
16.0160 15 cm
16.0164 20 cm



BERNHARD
16.0170 16,5 cm



MOYNIHAN
16.0180 19 cm

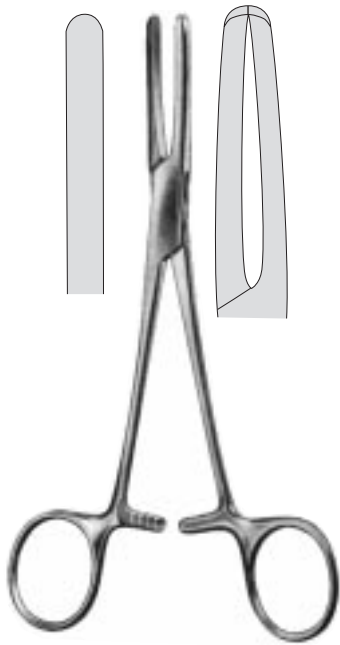

PRESBYTERIAN
 16.0200 16 cm
 16.0202 18 cm



KLINIK-BERLIN
 16.0210 14,5 cm

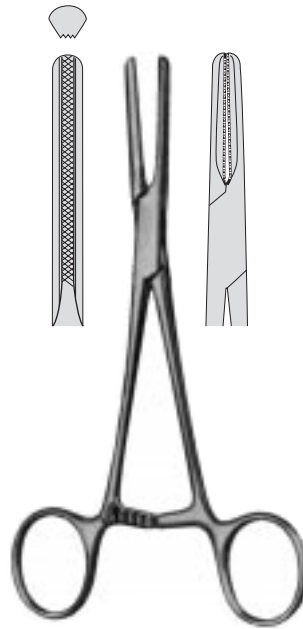

USA-MODEL
 16.0220 16 cm
 16.0222 18 cm
 16.0224 20 cm

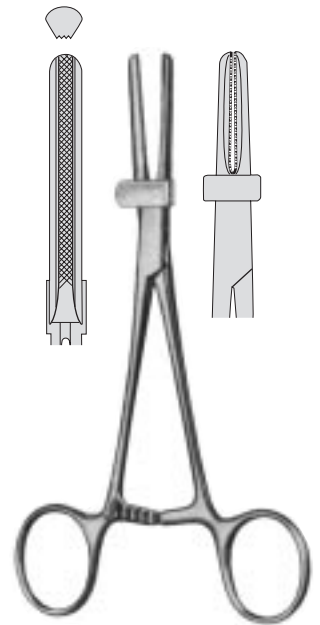

TUBING
 16.0230 16 cm
 16.0232 18 cm
 16.0234 20 cm

Schlauchroller
 Tube milking clamps
 Pincés à traire les drains
 Rodillos para tubos
 Pinze pressa tubi con rulli



BROMPTON
 16.0280 15,5 cm



CUNNAR-HEY
 16.0290 19 cm



BERGMANN-FOERSTER
 16.0390 24 cm



BERGMANN-FOERSTER
 16.0391 24 cm

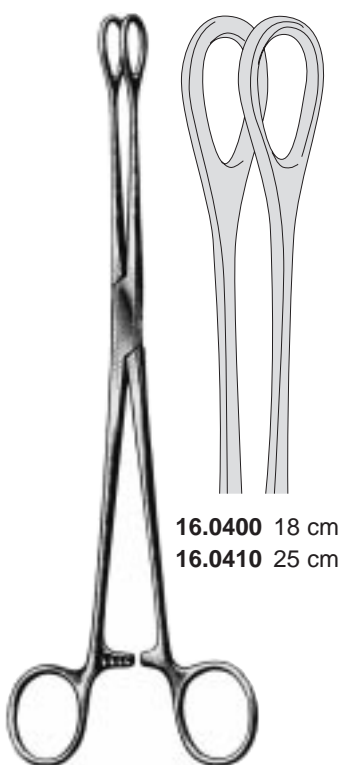

16.0400 18 cm
16.0410 25 cm

FOERSTER

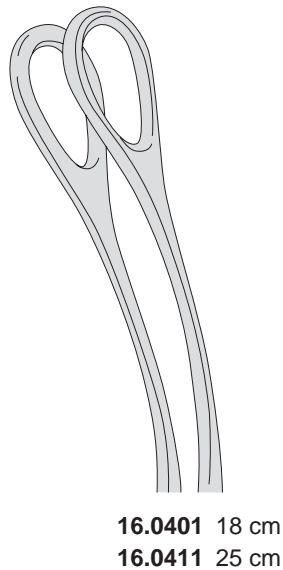

16.0401 18 cm
16.0411 25 cm

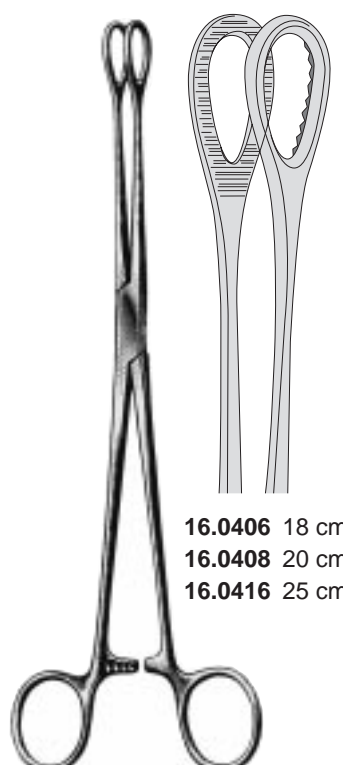

16.0406 18 cm
16.0408 20 cm
16.0416 25 cm

BALLENGER

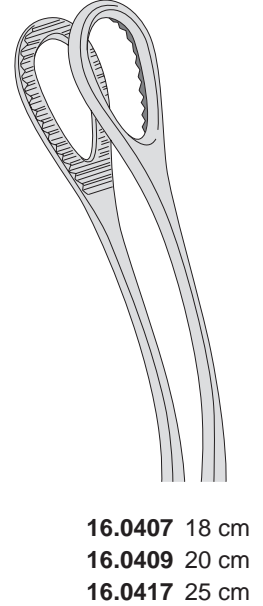

16.0407 18 cm
16.0409 20 cm
16.0417 25 cm

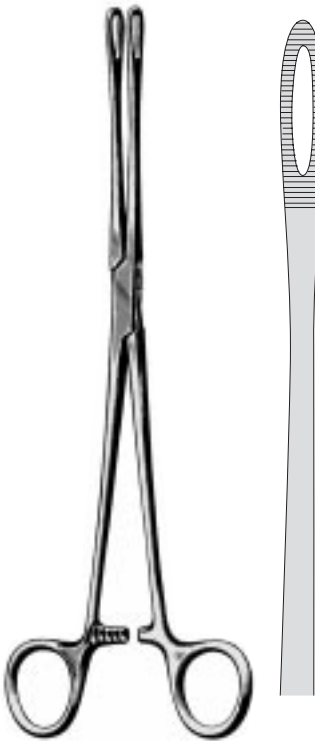

FOERSTER-DELIKAT
25 cm

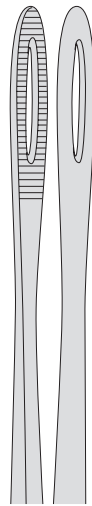

16.0418

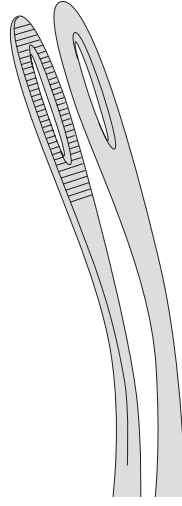

16.0419



RAMPLEY
16.0420 25 cm

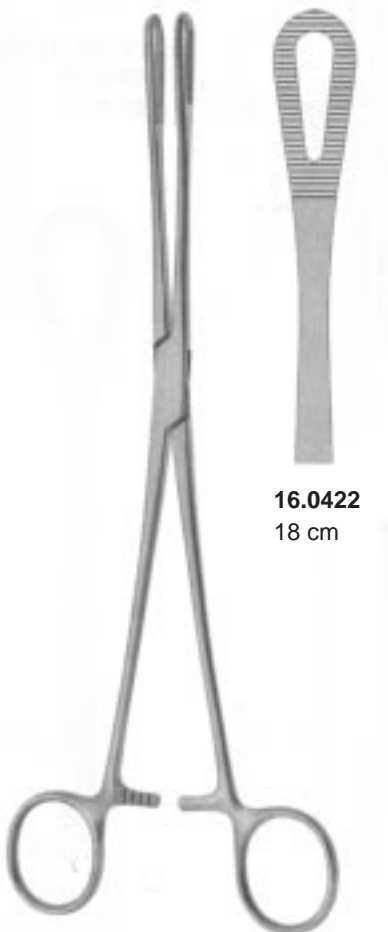

16.0422
18 cm



16.0423
25 cm



FLETCHER (Javerts)
16.0424 24 cm



FLETCHER (Javerts)
16.0425 24 cm

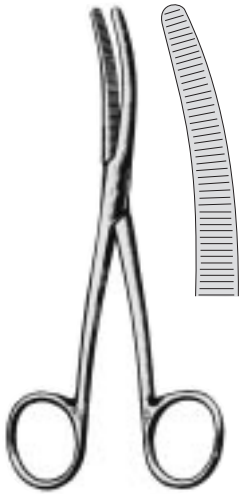

BRYANT
 16.0300 13 cm



LISTER-SINUS
 16.0360 13 cm
 16.0362 16 cm
 16.0364 18 cm



WALTON
 16.0370 17 cm



WALTON
 16.0371 17 cm



SIMS-MAIER
 16.0426 28 cm



SIMS-MAIER
 16.0427 28 cm



PELKMANN
 16.0430 25 cm



PELKMANN
 16.0431 25 cm



DUPLAY
 16.0440 20 cm

16.0441



GROSS
 16.0450 20 cm
 16.0452 22 cm
 16.0454 26 cm

16.0451 20 cm
 16.0453 22 cm
 16.0455 26 cm

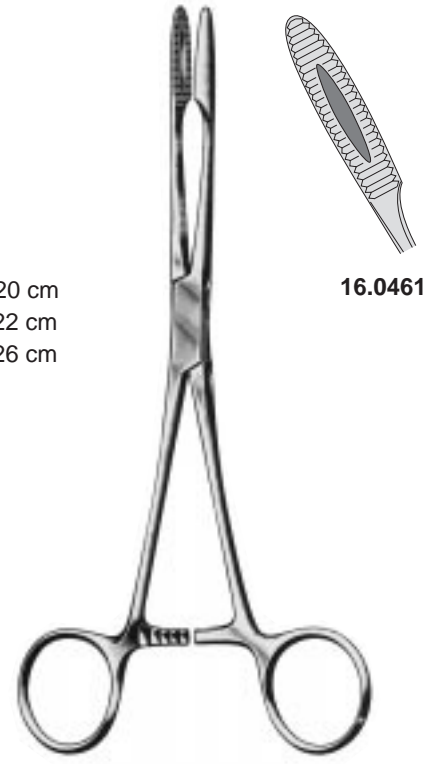

MAIER
 16.0460 25 cm

16.0461

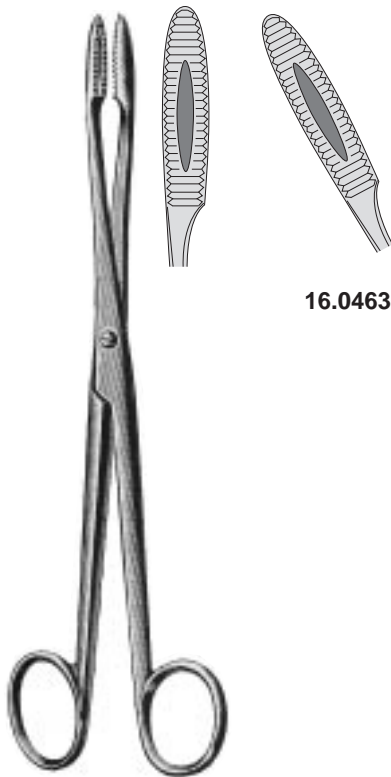

MAIER
 16.0462 25 cm

16.0463



EMMET
 16.0466 21 cm

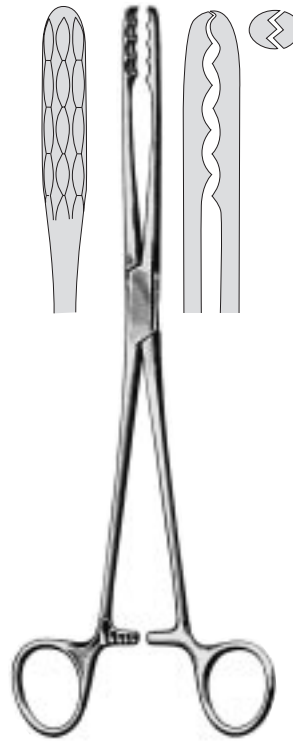

ULRICH
 16.0470 22 cm
 16.0472 25 cm



ULRICH
 16.0471 22 cm
 16.0473 25 cm

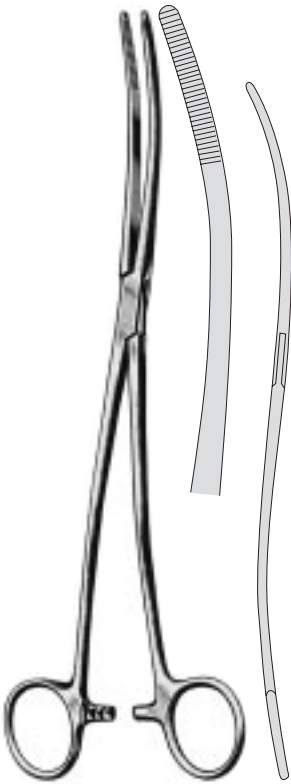

BOZEMANN

16.0500 26 cm

gerade /straight /droit /recto /retto

16.0501 26 cm

gebogen /curved / courbe /curvo /
curvo

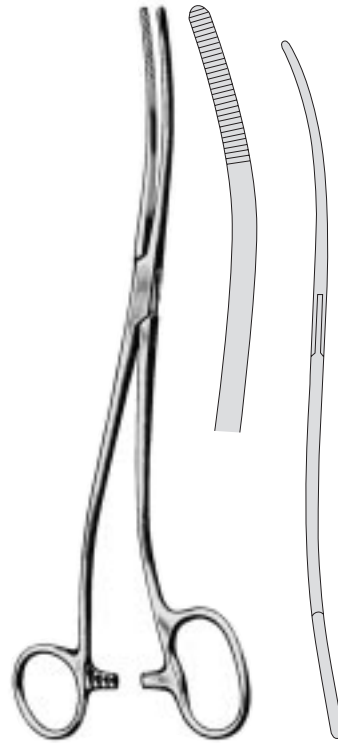

BOZEMAN-DOUGLAS

16.0505 25 cm



CHERON

16.0510 25 cm

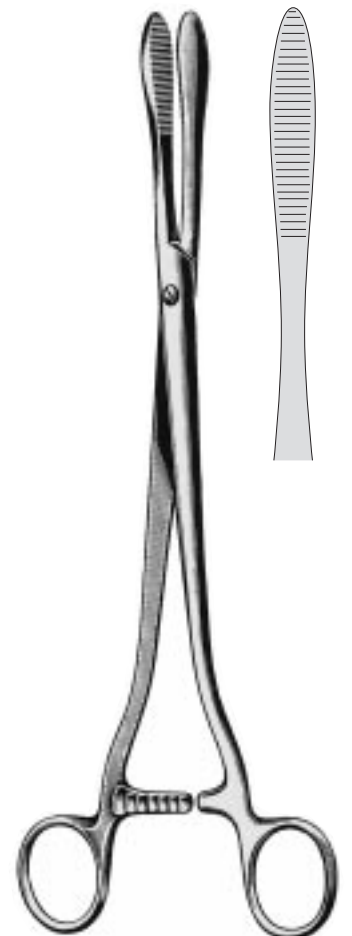

COLLIN

16.0520 25 cm



DAVIS
 16.1000 16 cm
 16.1002 20 cm
 16.1004 25 cm



CHEATLE
 16.1010 27 cm



ROGGE
 16.1020 23 cm



STERILIZING
 16.1030 20 cm
 16.1032 30 cm



STERILIZING
 16.1040 20 cm
 16.1042 28 cm

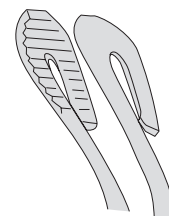

16.1041 20 cm
 16.1043 28 cm



HARRISON
 16.1050 25 cm
 16.1052 30 cm



MARTIN
 16.1060 58 cm



SAUERBRUCH
 16.1070 55 cm



BUNT
 16.1100
 12 cm



MAYO
 16.1110
 14 cm



MAYO
 16.1115
 14 cm



STRINGER

16.1150	10 x 7 cm
16.1152	15 x 7 cm
16.1153	20 x 7 cm
16.1154	25 x 7 cm
16.1155	30 x 7 cm
16.1156	35 x 7 cm
16.1157	40 x 7 cm
16.1158	45 x 9 cm
16.1159	50 x 9 cm



16.1500

Infusionsflaschen-Öffnungszange
 Infusion-bottle Opening Forceps
 Pince pour ouvrir les bouteilles d'infusion
 Pinza para abrir botellas de infusión
 Pinza apri flebo



WUNDHAKEN
RETRACTORS
ECARTEURS
SEPARADORES
DIVARICATORI

Häkchen für Ophthalmologie
 Hooklets for Ophthalmology
 Crochets pour Ophthalmologie
 Ganchitos para Oftalmologia
 Uncini per Oftalmologia

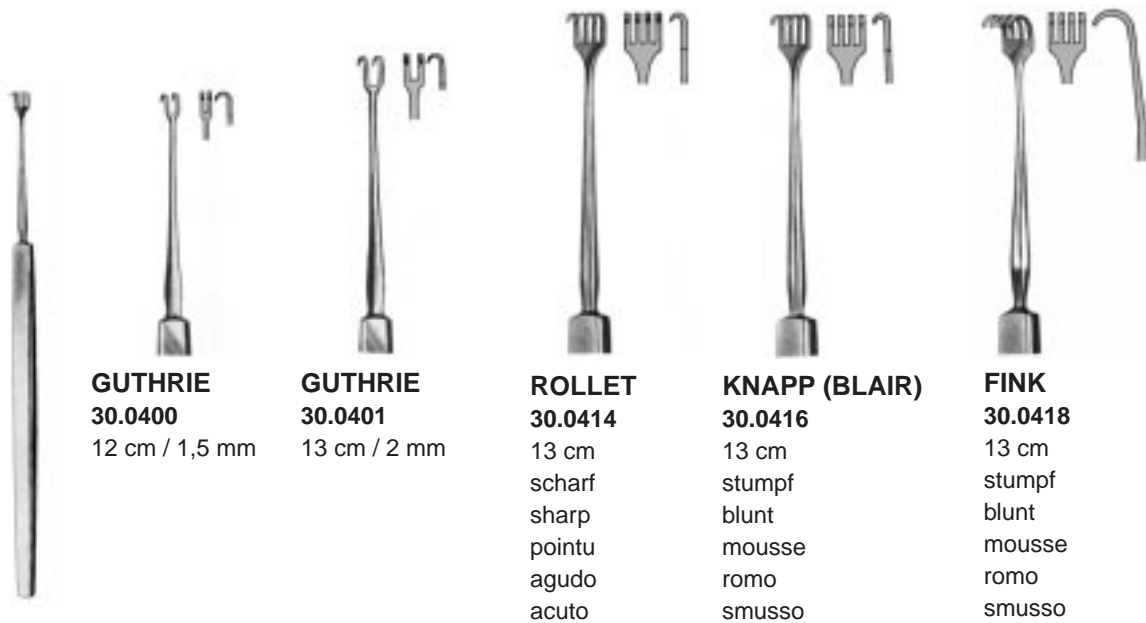

GUTHRIE
30.0400
 12 cm / 1,5 mm

GUTHRIE
30.0401
 13 cm / 2 mm

ROLLET
30.0414
 13 cm
 scharf
 sharp
 pointu
 agudo
 acuto

KNAPP (BLAIR)
30.0416
 13 cm
 stumpf
 blunt
 mousse
 romo
 smusso

FINK
30.0418
 13 cm
 stumpf
 blunt
 mousse
 romo
 smusso

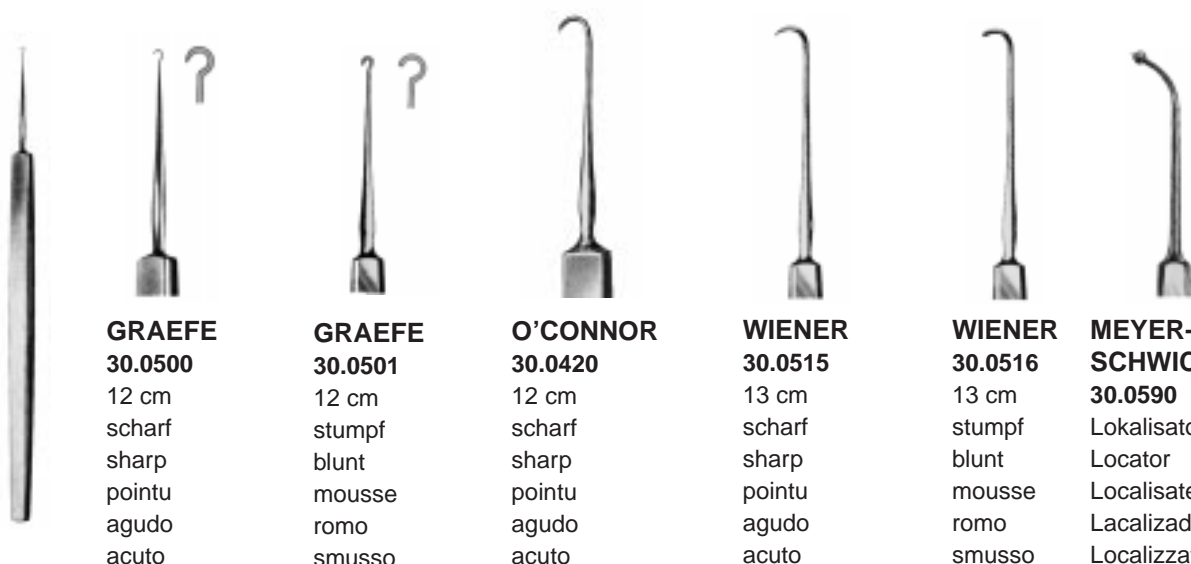

GRAEFE
30.0500
 12 cm
 scharf
 sharp
 pointu
 agudo
 acuto

GRAEFE
30.0501
 12 cm
 stumpf
 blunt
 mousse
 romo
 smusso

O'CONNOR
30.0420
 12 cm
 scharf
 sharp
 pointu
 agudo
 acuto

WIENER
30.0515
 13 cm
 scharf
 sharp
 pointu
 agudo
 acuto

WIENER
30.0516
 13 cm
 stumpf
 blunt
 mousse
 romo
 smusso

MEYER-SCHWICKERATH
30.0590
 Lokalisator
 Locator
 Localisateur
 Localizador
 Localizzatore



30.0430
 14 cm
 scharf
 sharp
 pointu
 agudo
 acuto



30.0432
 14 cm
 scharf
 sharp
 pointu
 agudo
 acuto



30.0431
 14 cm
 stumpf
 blunt
 mousse
 romo
 smusso



30.0433
 14 cm
 stumpf
 blunt
 mousse
 romo
 smusso

AXENFELD



30.0502
 16 cm
 scharf
 sharp
 pointu
 agudo
 acuto



30.0503
 16 cm
 stumpf
 blunt
 mousse
 romo
 smusso

GRAEFE



BONN
30.0510
 14 cm



TÜBINGEN
 13,5 cm



30.0511



30.0512



30.0513
 45°



30.0514



30.0570
 rechts
 right
 à droite
 derecha
 destra



30.0571
 links
 left
 à gauche
 izquierda
 sinistra

DOPPELKRALLE
 11 cm

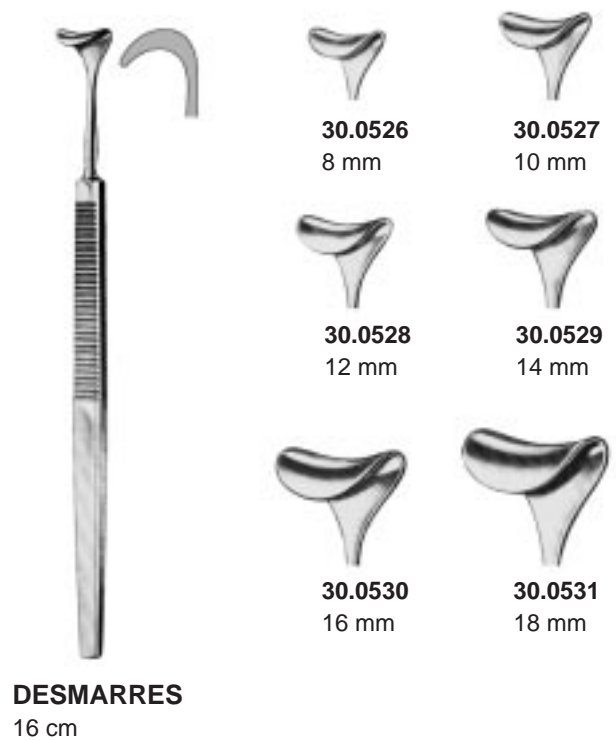
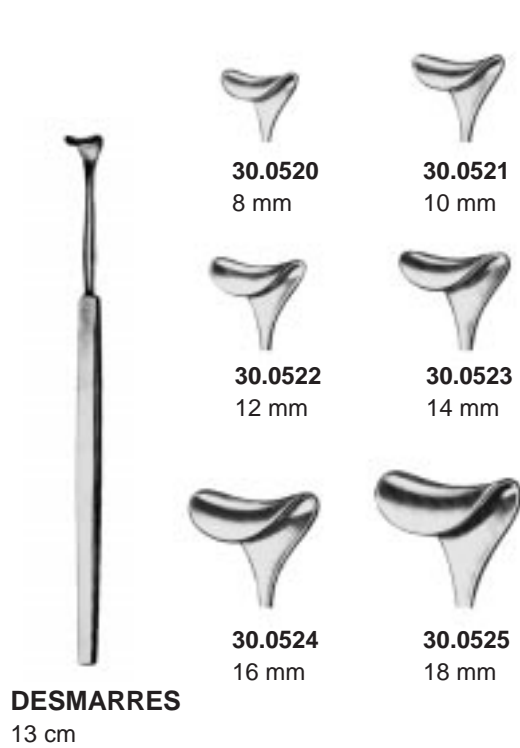

Schielhaken, Muskelhaken
 Strabismus- and Muscle hooks
 Crochets à strabisme, Crochets musculaires
 Ganchos para estrabismo y musculares
 Uncinetti per strabismo e per muscoli



Ohrhäkchen
 Ear hooklets
 Crochets auriculaires
 Ganchitos auriculares
 Uncini auricolari

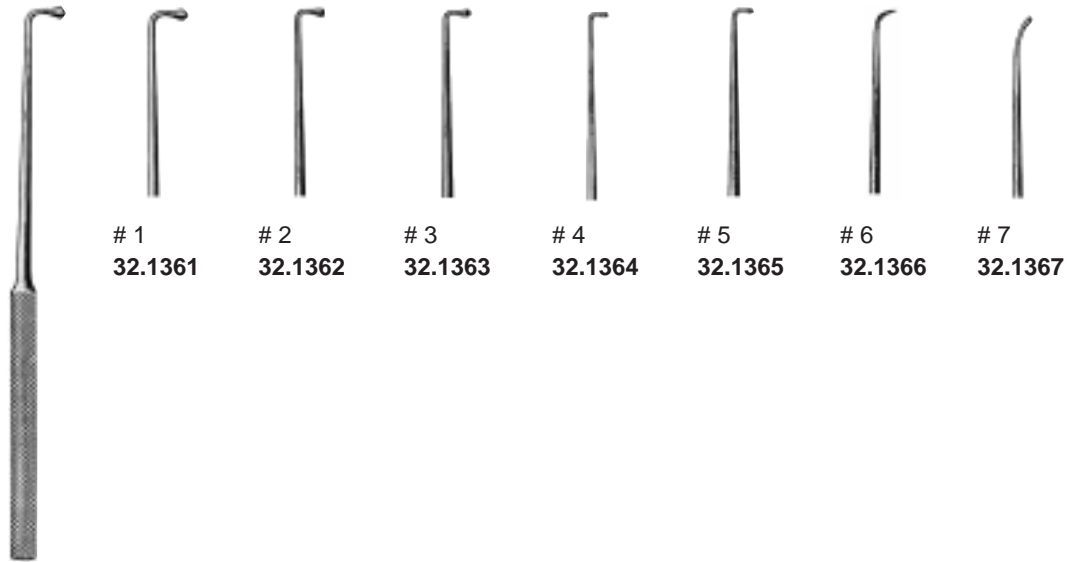

1 32.1361 # 2 32.1362 # 3 32.1363 # 4 32.1364 # 5 32.1365 # 6 32.1366 # 7 32.1367

WAGENER
 14 cm



ALLPORT
 32.1368
 16 cm



LUCAE
 14 cm



32.1376 #1
 32.1377 #2
 32.1378 #3



DAY
 16 cm

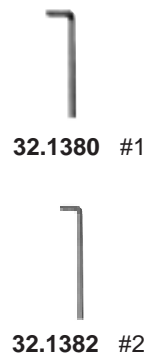

32.1380 #1
 32.1382 #2

Häkchen für Rhinologie
 Hooklets for Rhinology
 Crochets pour Rhinologie
 Ganchitos para Rinologia
 Uncini per Rinologia

Schleimhauthäkchen
 Mucosa Hooklets
 Crochets pour la muqueuse
 Ganchitos para mucosa
 Uncini per mucosa



FREER
 33.1910
 15 cm / 2 mm



JOSEPH
 33.1911
 15 cm



JOSEPH
 16 cm



33.1912
 2 mm



33.1915
 5 mm



33.1917
 7 mm



33.1920
 10 mm



COTTLE
 33.1921
 16 cm



COTTLE
 14 cm



33.1922
 scharf
 sharp
 pointu
 agudo
 acuto



33.1923
 stumpf - scharf
 blunt - sharp
 mousse - pointu
 romo - agudo
 smusso - acuto



33.1924
 scharf - stumpf
 sharp - blunt
 pointu - mousse
 agudo - romo
 acuto - smusso



COTTLE
 15 cm

33.1925
 # 1

33.1926
 # 2

33.1927
 # 3



BARSKY
33.1929
15 cm



FOMON
33.1930
17 cm



FOMON
33.1932
17 cm



COTTLE
33.1935
14 cm



MALTZ
33.1938
16,5 cm



LANGE
33.1940
22 cm

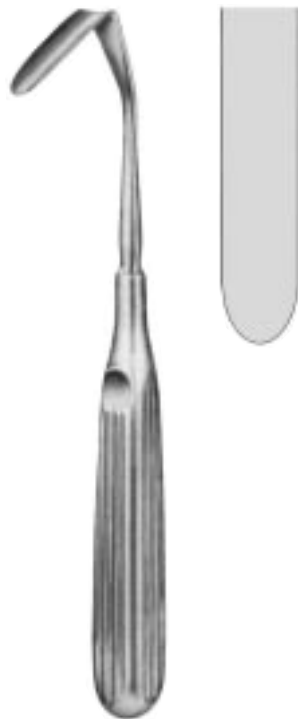

AUFRICHT
33.1950
19 cm



AUFRICHT
33.1952
13,5 cm



NEIVERT
33.1960
16 cm



COTTLE
33.1962
20 cm



KILNER
33.1966
10 cm



CONVERSE-ALAR
33.1970
12 cm



COTTLE-ALAR
33.1972
15 cm

Nasenflügelhäkchen
Alar Hooklets
Crochets pour les ailes du nez
Ganchitos para alas de nariz
Uncini per le pinne nasali



CONVERSE
33.1975
11 cm



COTTLE (Millard)
33.1976
5,5 cm

Spinalhaken
Spinal hooks
Ecarteurs spinaux
Separadores espinales
Divaricatori spinali



TAYLOR
27.1150
75 x 30 mm
27.1152
100 x 30 mm



CLOWARD
27.1160
76 x 13 mm
27.1161
76 x 18 mm
27.1162
76 x 20 mm
27.1163
76 x 23 mm

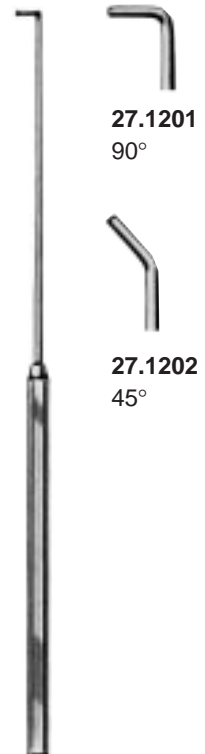

CRILE
20 cm



HOEN
27.1206
22 cm



ADSON
27.1210 20 cm
spitz / sharp
pointu / agudo / acuto



ADSON
27.1211 20 cm
stumpf / blunt
mousse / romo / smusso



GRAHAM
27.1220
16,5 cm



SACHS
27.1222
18 cm



SMITHWICK
27.1226
17 cm

SMITHWICK
27.1228
21 cm

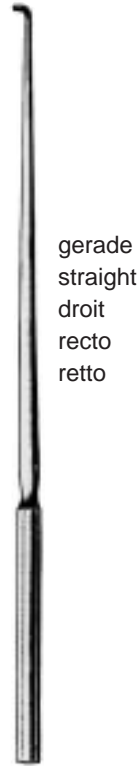

DANDY
27.1230
20 cm



DANDY
27.1231
20 cm



DANDY
27.1232
20 cm

gerade
straight
droit
recto
retto

links
left
à gauche
izquierdo
sinistro

rechts
right
à droite
derecho
destro



CUSHING
27.1240 19 cm / 5 mm
27.1245 28 cm / 5 mm



CUSHING
27.1241 19 cm / 8 mm
27.1246 28 cm / 8 mm



LAHEY
27.1305
13 cm



FRAZIER



27.1310
13 cm
spitz
sharp
pointu
agudo
acuto



27.1311
13 cm
stumpf
blunt
mousse
romo
smusso



27.1312
18 cm
spitz
sharp
pointu
agudo
acuto



27.1313
18 cm
stumpf
blunt
mousse
romo
smusso



CUSHING
27.1320
14 cm

schneidend
cutting
coupante
cortante
tagliente



CUSHING
27.1325
14 cm



CLOWARD
27.1330
16,5 cm



TOENNIS
27.1340
15 cm



SCOVILLE
 27.1390
 23 cm / 8 mm



SCOVILLE
 27.1391
 23 cm / 8 mm



LOVE
 27.1400
 19 cm/7 mm



LOVE
 27.1402
 18 cm/7 mm



LOVE
 27.1404
 11 cm/7 mm



LOVE
 27.1406
 21 cm



SCOVILLE
27.1410
30,5 cm



SCOVILLE
27.1412
30,5 cm



HOLSHER
27.1413
25 cm / 7 mm



CUSHING
27.1420
20 cm

Dekompressionshaken
Decompression hook
Crochet pour décompression
Gancho para decompresión
Gancio per decompressione



D'ERRICO
27.1425
23 cm

Nervwurzelhaken
Nerve root retractor
Rétracteur pour racines nerveuses
Separador para la raíz de nervios
Separatore per le radici die nervi



OLDBERG
20 cm



27.1430



27.1431



27.1432



27.1433

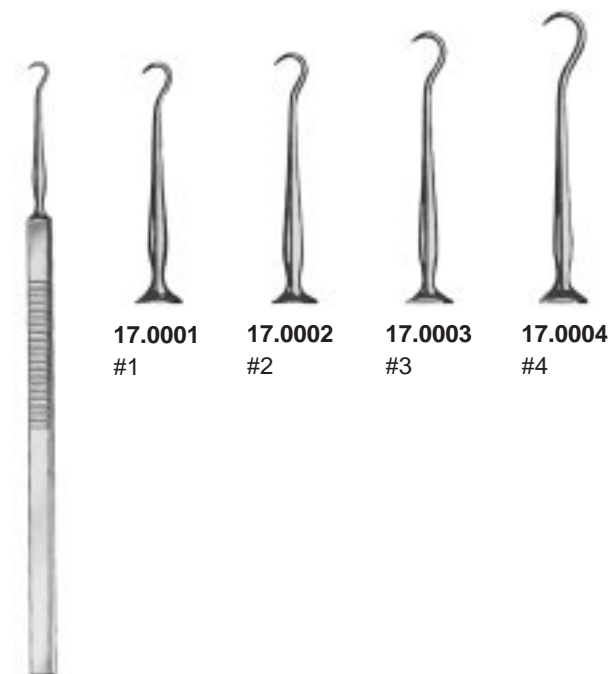

17.0001 #1
 17.0002 #2
 17.0003 #3
 17.0004 #4

Gefäßhäkchen
 Vessel Hook
 Crochet pour vaisseaux
 Ganchito vascular
 Uncino vascolare



17.0012
 12 cm



BERGMANN
 17.0037
 14 cm

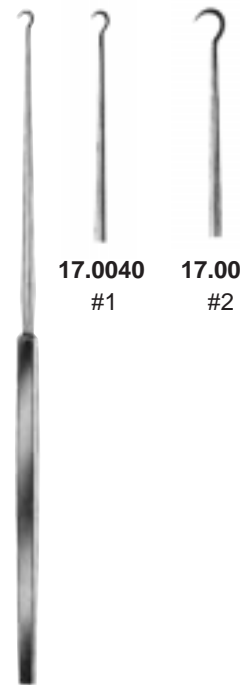

17.0040 #1
 17.0041 #2

GILLIES
 18 cm

16 cm



GILLIES
 17.0043 18 cm

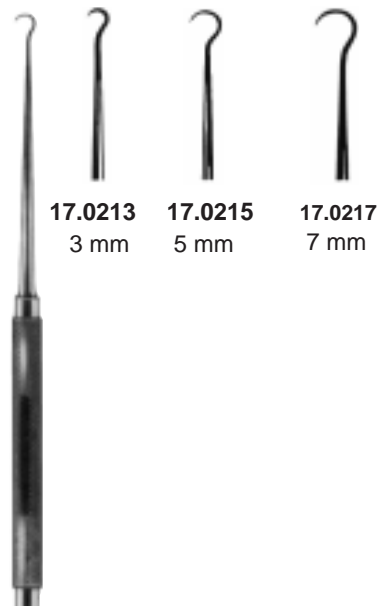

17.0213 3 mm
 17.0215 5 mm
 17.0217 7 mm

KLEINERT-KUTZ
 13 cm



KILNER
 58.0010 15,5 cm



17.0050 17.0052

Venenhäkchen
 Vein Hooks
 Crochets pour veines
 Ganchitos para venas
 Uncini per veni

BROM
 19 cm



MANNERFELT
 17.1901
 13,5 cm



MANNERFELT
 17.1902
 15,5 cm



MANNERFELT
 17.1904
 15,5 cm

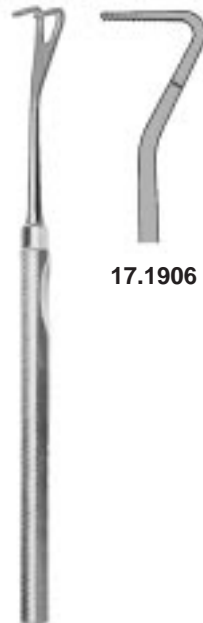

MANNERFELT
 17.1906
 15,5 cm



17.1908



MANNERFELT
 17.1933
 15,5 cm

flexibel
 flexible
 flexible
 flexible
 flessibile



17.1911



17.1912



17.1913

MANNERFELT
 15,5 cm
 spitz
 sharp
 pointu
 agudo
 acuto



17.1916



17.1917



17.1918

MANNERFELT
 15,5 cm
 stumpf
 blunt
 mousse
 romo
 smusso



17.1921



17.1922



17.1923

MANNERFELT
 15,5 cm
 spitz
 sharp
 pointu
 agudo
 acuto



17.1926



17.1927



17.1928

MANNERFELT
 15,5 cm
 stumpf
 blunt
 mousse
 romo
 smusso



MANNERFELT
15,5 cm



17.1940 16x6 mm



MANNERFELT
15,5 cm



17.1943 15x6 mm



17.1944 20x6 mm



17.1945 25x6 mm



17.1946 30x8 mm



MANNERFELT
15,5 cm



17.1948 12x12 mm



17.1949 12x14 mm



17.1951 14x16 mm



MANNERFELT
15,5 cm



17.1958 12x12 mm



MILLER
 13,5 cm



17.0480
 spitz
 sharp
 pointu
 agudo
 acuto

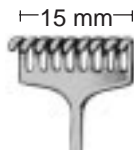

17.0481
 stumpf
 blunt
 mousse
 romo
 smusso



17.0390 16,5 mm
 spitz
 sharp
 pointu
 agudo
 acuto



17.0391 16,5 mm
 stumpf
 blunt
 mousse
 romo
 smusso

Trachealhäkchen / Trachea hooklets / Crochets pour trachéotomie / Ganchitos para la tráquea / Uncini tracheali



17.0401



17.0411



17.0421



17.0431



17.0401 - 17.0414
 16 cm



17.0402



17.0412



17.0422



17.0432



17.0403



17.0413



17.0423



17.0433



17.0404
 spitz/sharp
 pointu /agudo
 acuto



17.0414
 stumpf/blunt
 mousse/romo
 smusso

flexibel
 flexible
 flexible
 flexible
 flessibile



17.0421 - 17.0434
 16 cm



17.0424
 spitz/sharp
 pointu /agudo
 acuto



17.0434
 stumpf/blunt
 mousse/romo
 smusso



MEYERDING
 18 cm



17.0451 #1



17.0452 #2



17.0453 #3



17.0454 #4



17.0455 #5



17.0456 #6



17 cm



17.0471



17.0472



17.0473



17.0474

spitz
 sharp
 pointu
 agudo
 acuto



17.0476



17.0477



17.0478



17.0479

stumpf
 blunt
 mousse
 romo
 smusso



17.0500 14 x 5 mm



17.0501 17 x 5 mm



17.0502 25 x 6 mm

MOBERG
17 cm

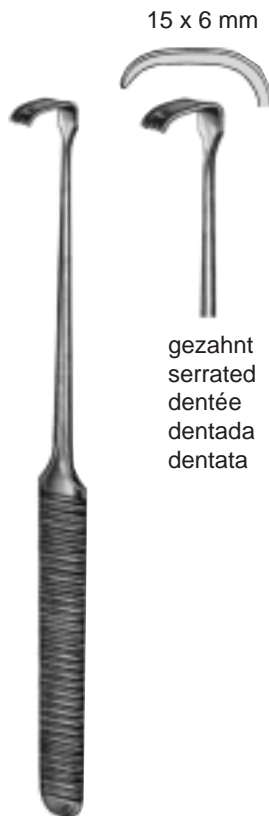

15 x 6 mm

gezahnt
serrated
dentée
dentada
dentata

STRANDELL-STILLE
17.0510 19 cm

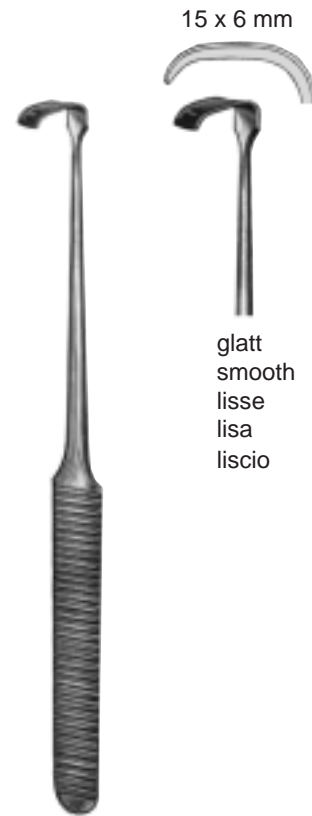

15 x 6 mm

glatt
smooth
lisse
lisa
liscio

STRANDELL-STILLE
17.0512 19 cm



17.0515



17.0516

KLAPP
17,5 cm



17.0520
13 x 13 mm



17.0522
12 x 16 mm

KÖNIG
18 cm



CRILE
 17.0530 11 cm



LUER
 17.0535 11 cm



HOUSE
 17.0540 15 cm



RAGNELL-DAVIS
 17.0585 14 cm



SENN-MILLER
 17.0580, 17.0581
 16 cm



17.0580
 17.0588



17.0581
 17.0589



MATHIEU
 17.0588, 17.0589
 16 cm



SENN-MILLER-BABY
 15 cm



17.0582



17.0583



COPE
 17.0566
 18 cm



JACKSON
 36.0500
 13 cm



JACKSON
 18 cm



36.0502
 spitz
 sharp
 pointu
 agudo
 acuto



36.0503
 stumpf
 blunt
 mousse
 romo
 smusso



JACKSON
 36.0504
 18 cm



ROSE
 36.0550
 13 cm

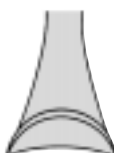

NEWS
 36.0560
 15 cm



LUKENS
 36.0600
 17 cm





SENN-GREEN
15 cm



17.0560
10 x 6 mm



17.0562
20 x 6 mm



LANGENBECK-MINI
16 cm



17.0590
10 x 6 mm



17.0591
17 x 5 mm



17.0592
20 x 6 mm



17.0593
22 x 8 mm



17.0460
5 mm



17.0461
7 mm



17.0462
10 mm



17.0463
12 mm

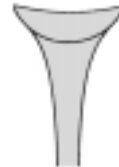

17.0464
15 mm

KIRKLIN
17.0460-17.0464
 13 cm,
 biegsam/malleable
 malléable/maleable
 malleabili



CUSHING
20 cm



17.0570
11 x 14 mm



17.0571
13 x 17 mm



CUSHING
25 cm



17.0577
14 x 11 mm



17.0578
18 x 13 mm



17.0579
22 x 15 mm



CUSHING
17.0575
 21 cm 10 x 11 mm



MARBERGER
20 cm



17.0671 8 mm



17.0672 11 mm



17.0673 15 mm



17.0674 17 mm



17.0675 20 mm



17.0676 23 mm

biegsam
malleable
malléable
maleable
malleabili



GIL-VERNET
24 cm



17.0680 9 mm



17.0681 11 mm



17.0682 13 mm



17.0683 15 mm



17.0684 18 mm

biegsam
malleable
malléable
maleable
malleabili





SPERMATIC
 51.0060
 16 cm

Samenstranghaken
 Spermatic cord hook
 Crochet pour cordon spermatic
 Gancho para cordón espermático
 Uncino per cordone spermatico



EMMET
 22 cm



55.1551
 # 1



55.1552
 # 2



55.1553
 # 3



55.1554
 # 4



55.1555
 # 5

Fistelhaken
 Fistula hooks
 Crochets pour fistules
 Ganchitos para fistulas
 Uncini per fistole



SIMON
 55.1561
 22 cm



SIMON
 55.1562
 22 cm

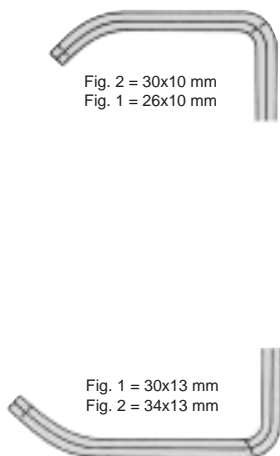

Fig. 2 = 30x10 mm
Fig. 1 = 26x10 mm

Fig. 1 = 30x13 mm
Fig. 2 = 34x13 mm

FARABEUF
17.0600 12 cm



Fig. 2 = 27x16 mm
Fig. 1 = 23x16 mm

Fig. 1 = 26x16 mm
Fig. 2 = 30x16 mm

FARABEUF
17.602 15 cm

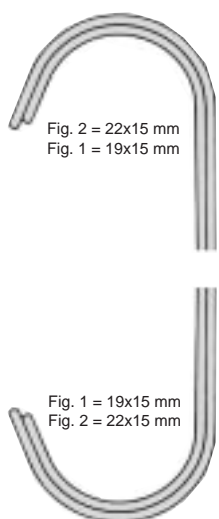

Fig. 2 = 22x15 mm
Fig. 1 = 19x15 mm

Fig. 1 = 19x15 mm
Fig. 2 = 22x15 mm

PARKER
17.0610 13,5 cm



Fig. 2 = 26x25 mm
Fig. 1 = 29x25 mm

Fig. 1 = 27x25 mm
Fig. 2 = 24x25 mm

PARKER
17.0612 18 cm

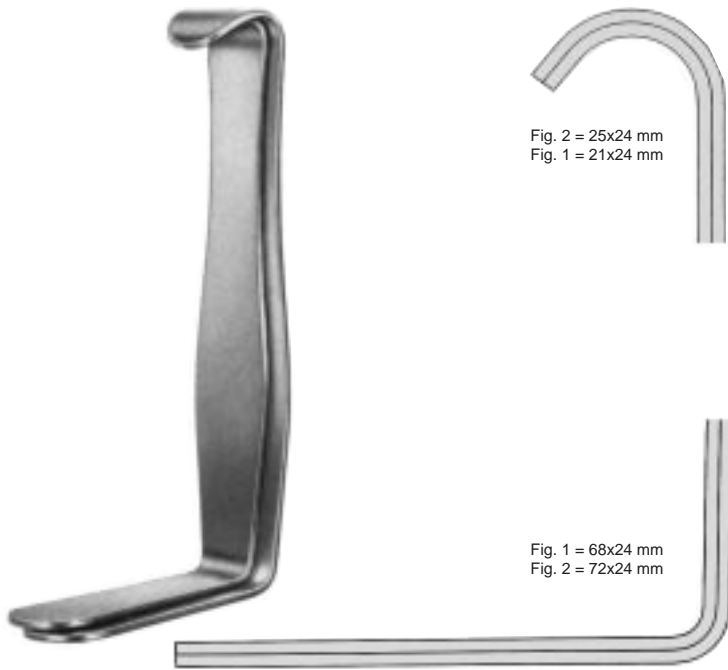

PARKER-MOTT
 17.0615 16 cm

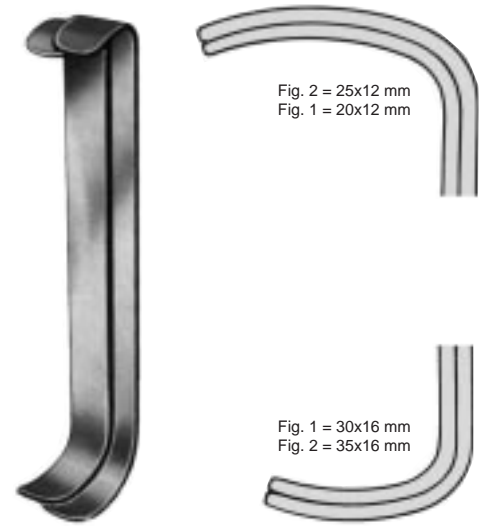

COLLIN
 17.0619 16 cm

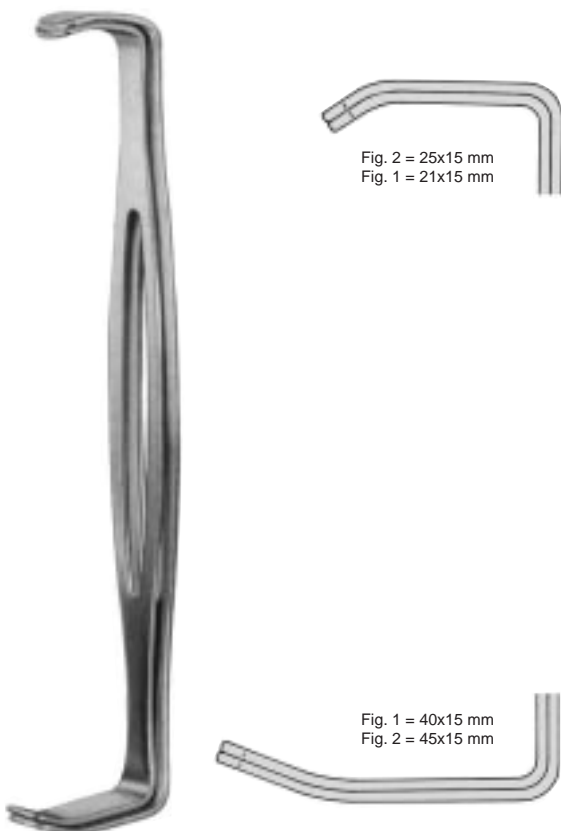

US-ARMY
 17.0630 21cm



17.0631 19 cm
 16x35 mm
17.0632 19 cm
 19x28 mm
17.0633 20 cm
 25x32 mm

CANNY-RYALL

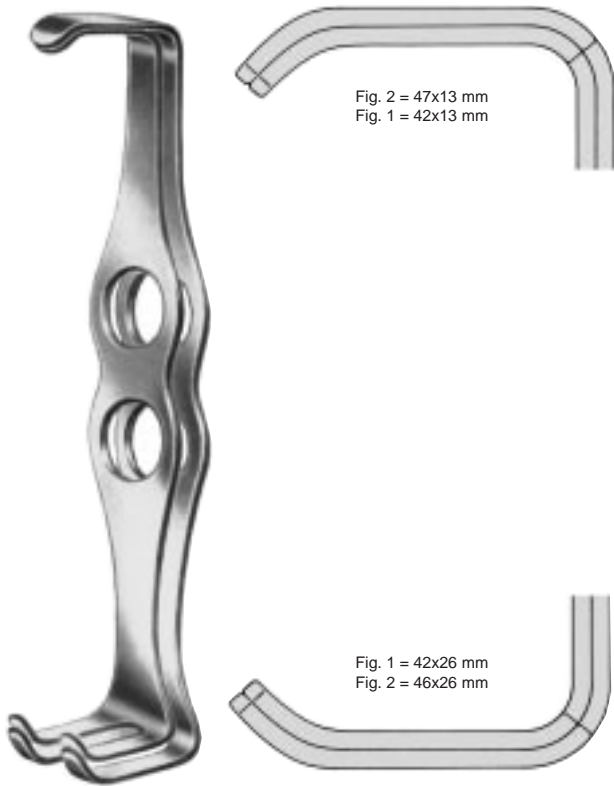

MATHIEU
 17.0635 20 cm

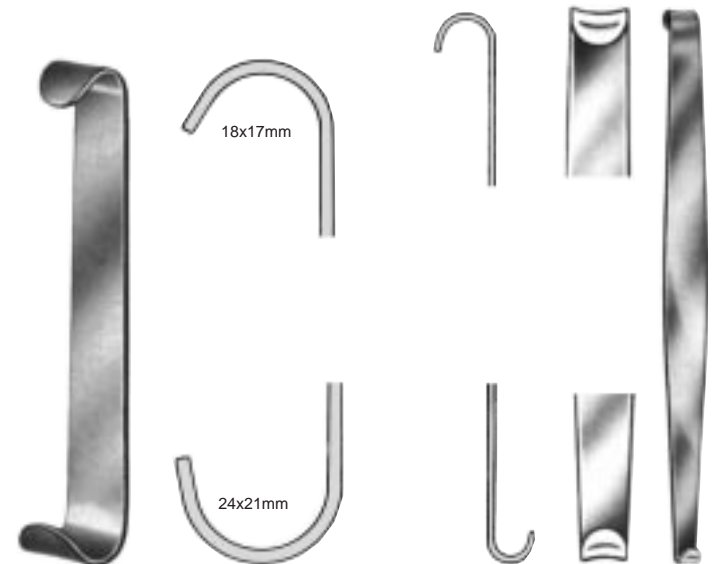

ROUX-BABY
 17.0650 13 cm

ROUX-MINI
 17.0654 14 cm

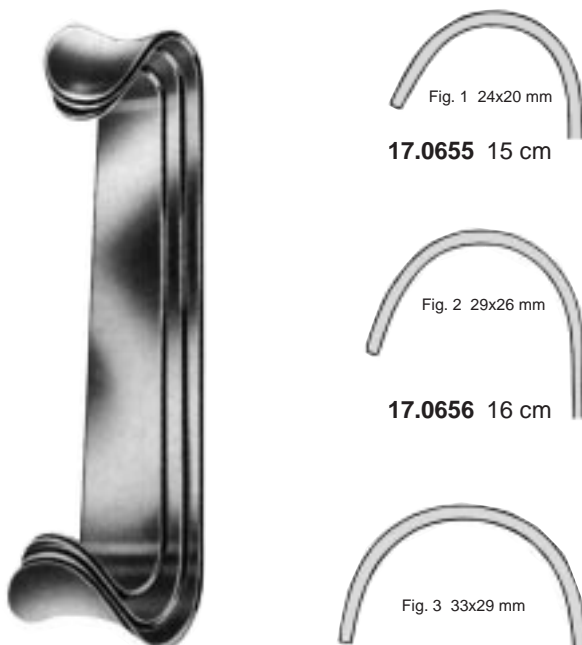

ROUX
 17.0659
 Satz #1-3 15/16/17 cm

Fig. 1 24x20 mm
 17.0655 15 cm

Fig. 2 29x26 mm
 17.0656 16 cm

Fig. 3 33x29 mm
 17.0657 17 cm



COLLIN-HARTMANN
 17.0660 16 cm



CZERNY
17.0662 18 cm



MORRIS
24cm
17.0665 32x51/38x51 mm
17.0666 44x51/51x51 mm
17.0667 64x51/38x51 mm

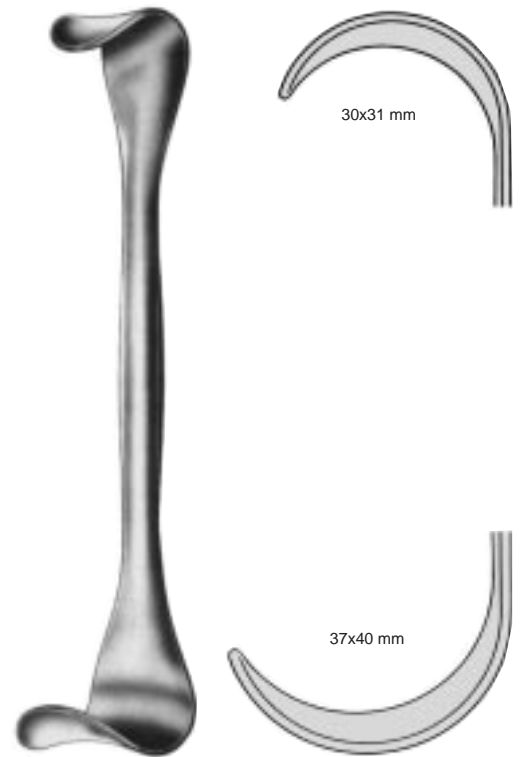

GOELET
17.0670 19 cm

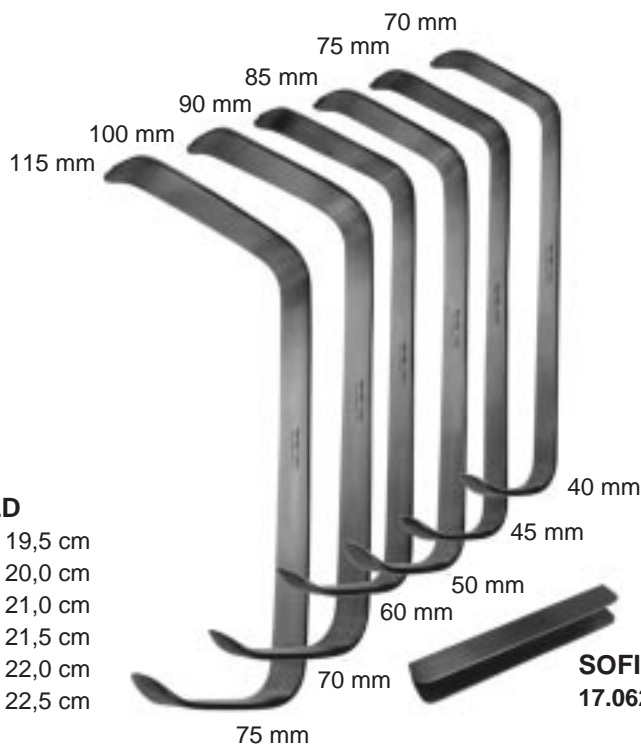

SOFIELD
17.0621 19,5 cm
17.0622 20,0 cm
17.0623 21,0 cm
17.0624 21,5 cm
17.0625 22,0 cm
17.0626 22,5 cm

SOFIELD
17.0629



SOFIELD
17.0620



VOLKMANN
 11,5 cm

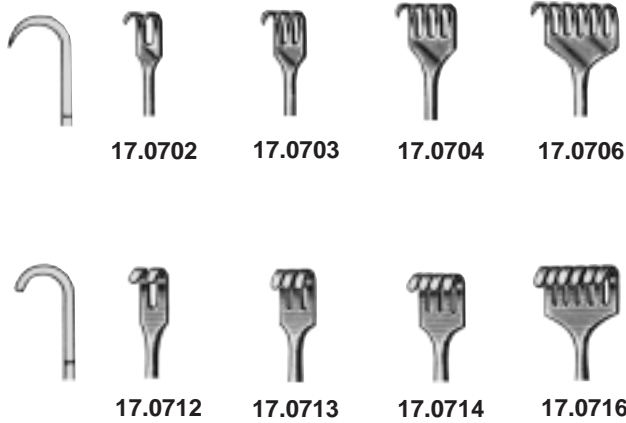

17.0702

17.0703

17.0704

17.0706

17.0712

17.0713

17.0714

17.0716



VOLKMANN
 21,5 cm



17.0721

17.0722

17.0723

17.0724

17.0726

17.0728

scharf / sharp / pointu / agudo / acuto



17.0731

17.0732

17.0733

17.0734

17.0736

17.0738

stumpf / blunt / mousse / romo / smusso



17.0741

17.0742

17.0743

17.0744

17.0746

17.0748

halbscharf / semi-sharp / semi-pointu / semiagudo / semi acuto



VOLKMANN
21,5 cm



17.0801



17.0802



17.0803



17.0804



17.0806

scharf / sharp / pointu / agudo / acuto



17.0811



17.0812



17.0813



17.0814

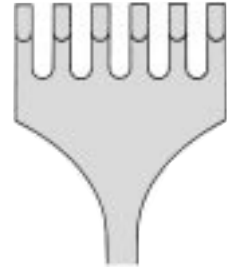

17.0816

stumpf / blunt / mousse / romo / smusso



17.0751



17.0752



17.0753



17.0754



17.0756



17.0758

scharf / sharp / pointu / agudo / acuto



KOCHER
22 cm



17.0761



17.0762



17.0763



17.0764



17.0766



17.0768

stumpf / blunt / mousse / romo / smusso



17.0771



17.0772



17.0773



17.0774



17.0776



17.0778

halbscharf / semi-sharp / semi-pointu / semi-agudo / semi acuto

Knochenhaken/Bone Retractors/Ecarteurs pour os/Separadores para huesos/Divaricatore per ossi



17.0780
25 cm



VOLKMANN
22 cm



17.0781



17.0782



17.0784



MURPHY
19 cm



17.0822



17.0823

scharf / sharp / pointu / agudo / acuto



17.0824



17.0826



17.0832



17.0833

stumpf / blunt / mousse / romo / smusso



17.0834



17.0836



WASSMUND
 17.0900 20 cm
 33 x 20 mm



OLLIER
 17.0912 22,5 cm
 36 x 60 mm



17.0910
 36 x 30 mm



KOERTE
 17.0922 24 cm
 stumpf
 blunt
 mousse
 romo
 smusso

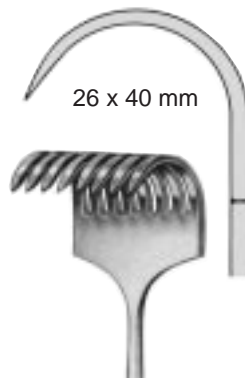

17.0920
 scharf
 sharp
 pointu
 agudo
 acuto



KOERTE
 17.0925
 23 cm
 stumpf
 blunt
 mousse
 romo
 smusso



ISRAEL
25 cm



17.0930
40 x 40 mm



17.0931
45 x 50 mm



17.0932
50 x 60 mm



17.0934
70 x 70 mm



28 x 6 mm



LAHEY
17.1000 19 cm



12 x 14 mm



LITTLE
17.1010 20 cm

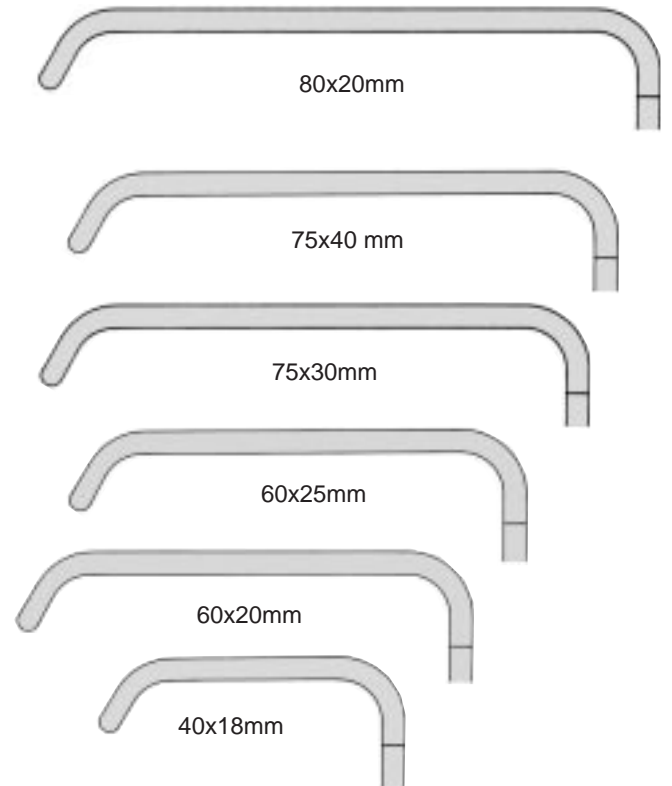
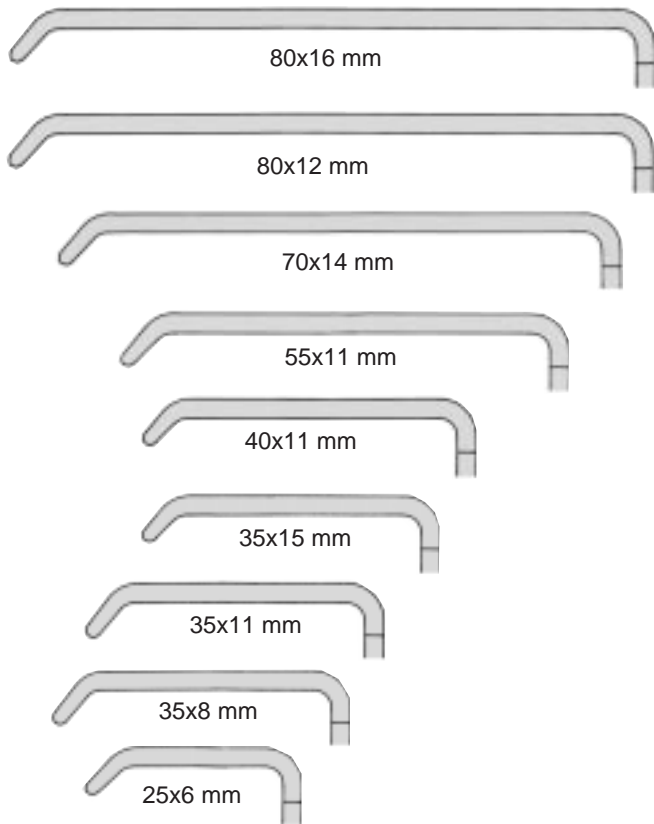



LANGENBECK
17.1040 - 17.1045
22 cm



17.1040 30 x 11 mm
17.1050 30 x 11 mm



17.1043 40 x 11 mm
17.1053 40 x 11 mm



17.1041 30 x 14 mm
17.1051 30 x 14 mm



17.1044 40 x 15 mm
17.1054 40 x 15 mm



17.1042 30 x 16 mm
17.1052 30 x 16 mm



17.1045 50 x 11 mm
17.1055 50 x 11 mm



LANGENBECK
17.1050 - 17.1055
22 cm



LANGENBECK
17.1049 22 cm
85 x 15 mm

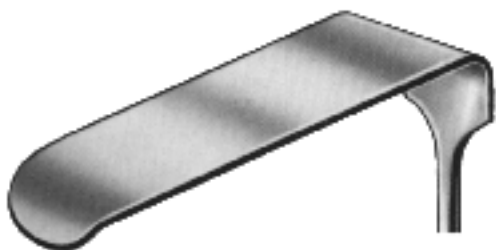

LANGENBECK
17.1056 60 x 20 mm
22 cm



17.1060 55 x 20 mm

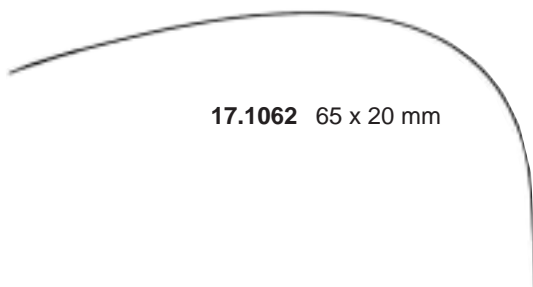

17.1062 65 x 20 mm

LANGENBECK
22 cm



67 x 17 mm

CASPAR
17.1068
20 cm



KOCHER
19 cm
17.1070 19 x 12 mm
17.1071 21 x 14 mm



KOCHER
22 cm
17.1072 40 x 10 mm
17.1073 40 x 15 mm
17.1074 40 x 20 mm



KOCHER
23 cm
17.1075 70 x 25 mm



KOCHER

25 cm

17.1076 80 x 45 mm

17.1077 80 x 55 mm

17.1078 80 x 65 mm



MIDDELDORPF

22 cm

17.1080 16 x 17 mm

17.1081 20 x 22 mm

17.1082 26 x 30 mm



MIDDELDORPF

26 cm

17.1083 45 x 45 mm

17.1084 45 x 50 mm

17.1085 55 x 70 mm



MIDDELDORPF

23 cm

17.1086 20 x 22 mm

17.1087 26 x 30 mm



GREEN

22 cm

17.1088 12 x 25 mm

Schilddrüsenhaken

Thyroid gland retractor

Ecarteur pour la thyroïde

Separador par la glándula tiroidea

Divaricatore per la tiroide



RICHARDSON

24 cm

17.1090 28 x 20 mm

17.1091 36 x 28 mm

17.1092 44 x 38 mm



49 x 38 mm

28 x 20 mm

36 x 28 mm

71 x 43 mm

RICHARDSON-EASTMANN

17.1097 Satz/Set/Jeu/Juego/Serie

17.1098 Klein/small/petit/chico/picolo

17.1099 Groß/large/grand/grande/grande



KELLY

26 cm

17.1095 65 x 50 mm

17.1096 70 x 63 mm



KELLY

23,5 cm

17.1101 38 x 51 mm

17.1102 51 x 64 mm

25,5 cm

17.1103 64 x 76 mm

17.1104 76 x 89 mm



KELLY

26 cm

17.1118 160 x 38 mm

17.1119 160 x 57 mm

17.1093 190 x 38 mm

17.1094 190 x 57 mm



DOYEN
25 cm
17.1100 85 x 50 mm



DOYEN-STILLE
20 cm
17.1105 90 x 28 mm
17.1106 105 x 30 mm
17.1107 120 x 52 mm



MORRIS
21 cm
17.1108 38 x 51 mm
17.1109 51 x 51 mm
17.1110 64 x 51 mm



HÖSEL
25 cm



17.1111 60x20mm



17.1112 63x30mm



17.1113 100x30mm



17.1114 120x30mm



17.1115 140x30mm



17.1116 140x40mm

17.1117 220x30mm

ohne Abb. / without illustration / sans illustration / sin ilustración / senza illustrazione



FRITSCH

24 cm

17.1120 35 x 40 mm

17.1121 45 x 40 mm

17.1122 45 x 50 mm

17.1123 45 x 60 mm

17.1124 55 x 75 mm

17.1125 65 x 80 mm



KOCHER-WAGNER

28 cm

17.1130 22 x 15 mm

17.1131 38 x 20 mm

17.1132 67 x 25 mm

17.1133 100 x 35 mm



TUEBINGEN

17.1154 28 cm

95 x 20 mm



MARTIN
17.1156 26 cm
105 x 27 mm

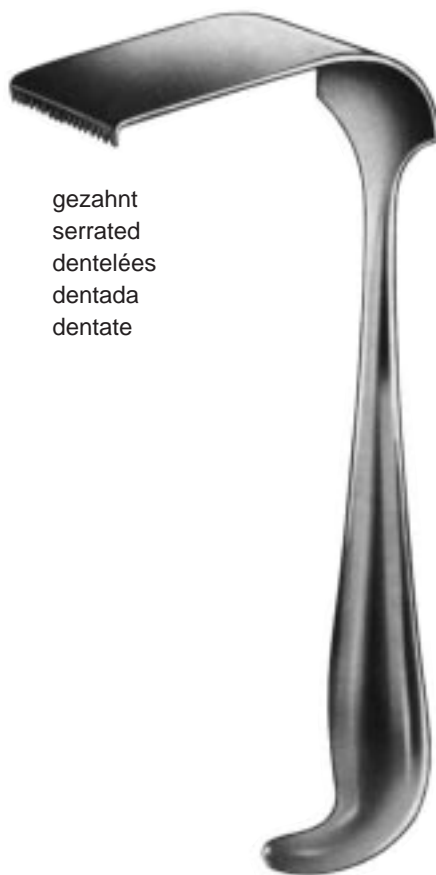

gezahnt
serrated
dentelées
dentada
dentate

MEYERDING
17.1160 22 cm
50 x 16 mm
17.1162 22 cm
75 x 25 cm
17.1164 24 cm
90 x 50 mm



MIKULICZ
17.1165 24 cm
90 x 50 mm



MIKULICZ
24 cm
17.1166 95 x 35 mm



MIKULICZ
26 cm
17.1167 120 x 50 mm
17.1168 155 x 50 mm
17.1169 180 x 50 mm



SAUERBRUCH
23 cm
17.1170 45 x 15 mm
17.1171 60 x 23 mm
17.1172 75 x 20 mm



SAUERBRUCH
17.1176 25 cm
125 x 37 mm

17.1180
82 x 22 mm

17.1181
115 x 38 mm

CORYLLOS
24 cm
17.1182 115 x 65 mm

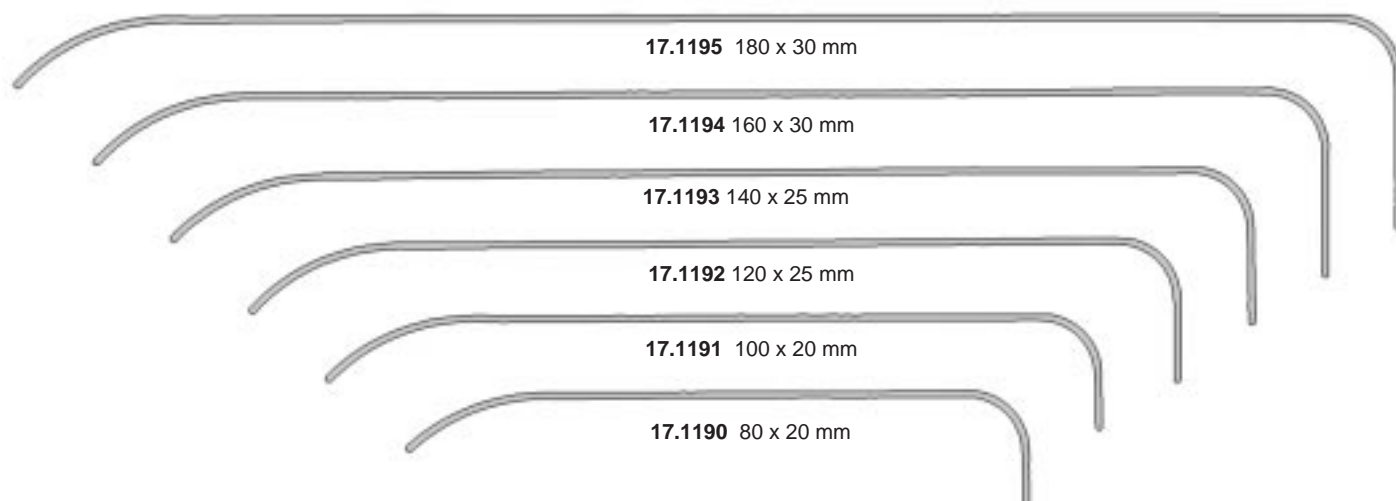

BRUNNER
17.1190 - 17.1195
25 cm

17.1209 180 x 30 mm

17.1208 160 x 30 mm

17.11207 140 x 30 mm

17.1206 130 x 30 mm

17.1205 120 x 25 mm

17.1204 100 x 25 mm

17.1203 80 x 20 mm



BRUNNER
17.1203 - 17.1209

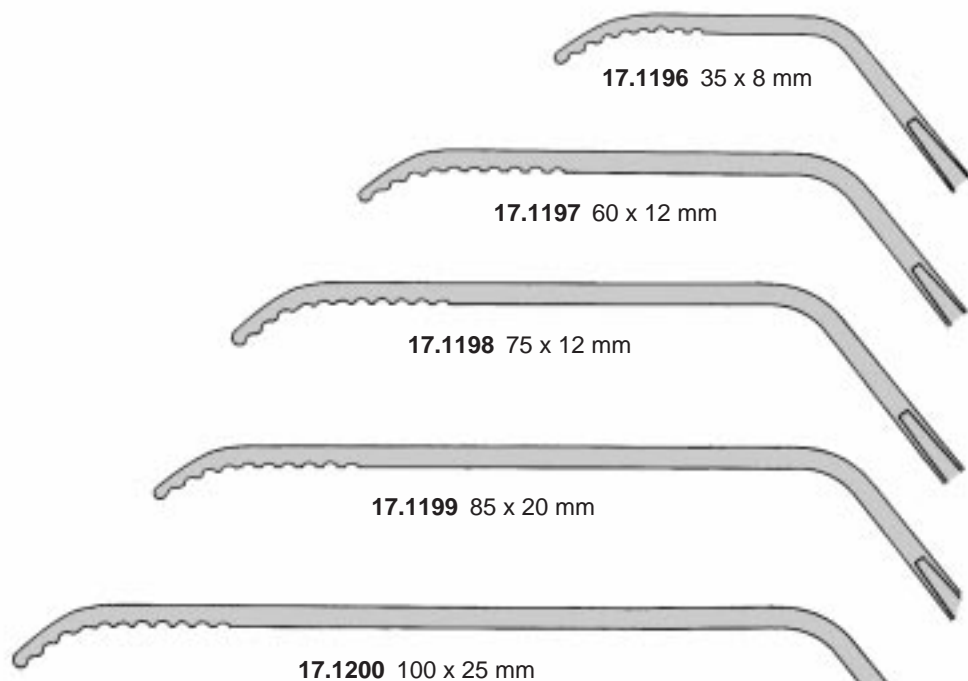

ZENKER
17.1196 - 17.1200
26 cm

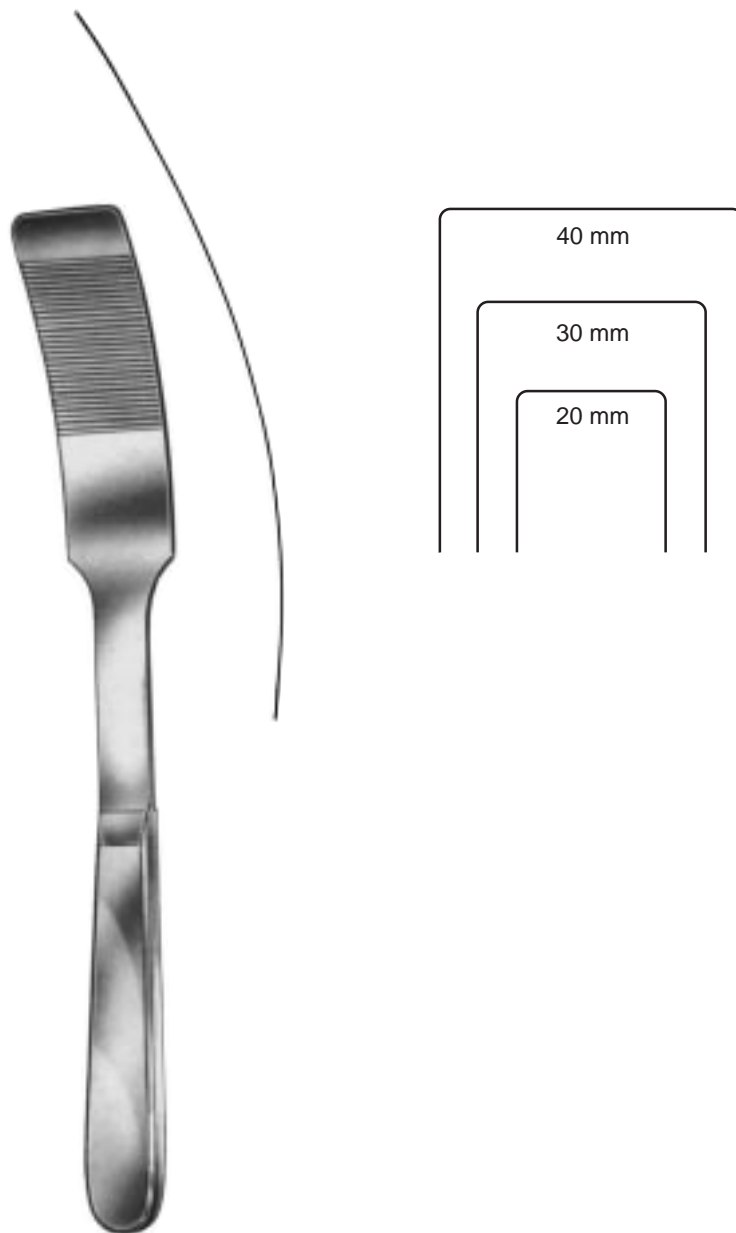

KADER

27 cm

17.1232 20 mm

17.1233 30 mm

17.1234 40 mm



RIBBON

17.1210 200 x 6 mm
 17.1211 200 x 8 mm
 17.1212 200 x 10 mm
 17.1213 200 x 12 mm

17.1214 200 x 17 mm
 17.1215 200 x 20 mm
 17.1216 200 x 25 mm
 17.1217 250 x 25 mm

biegsam
 malleable
 malléable
 maleable
 malleabili



RIBBON

17.1219 330 x 19 mm
 17.1220 330 x 25 mm
 17.1222 330 x 30 mm

17.1224 330 x 40 mm
 17.1226 330 x 50 mm

biegsam
 malleable
 malléable
 maleable
 malleabili



TUFFIER

17.1240 20 cm

25 / 17 mm

biegsam
 malleable
 malléable
 maleable
 malleabili



HABERER

17.1255 30 cm 37/45 mm
 17.1256 28 cm 25/30 mm
 17.1257 20 cm 17/25 mm

biegsam
 malleable
 malléable
 maleable
 malleabili



REVERDIN

17.1250 29 cm
 45x60 mm



REVERDIN

17.1251 28 cm
 45x60 mm

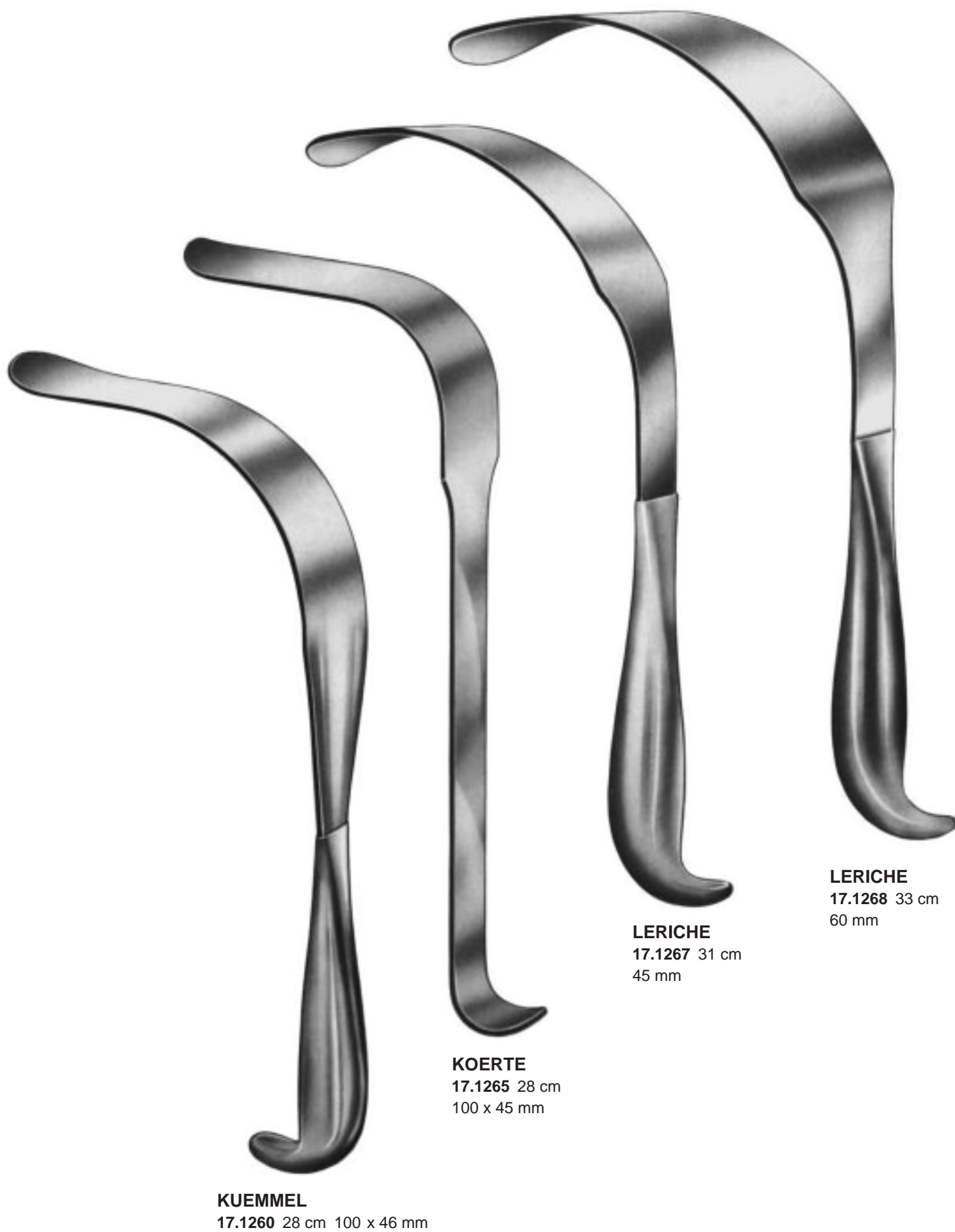



DEAVER
17.1273C-17.1279C

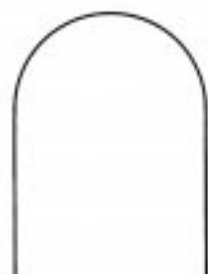

17.1273C
300 x 25 mm

17.1274C
330 x 25 mm

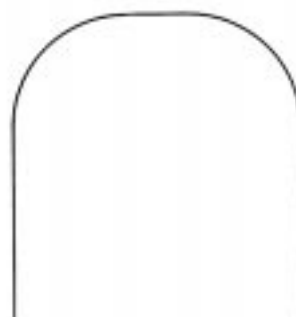

17.1276C
330 x 38 mm



17.1277C
330 x 50 mm

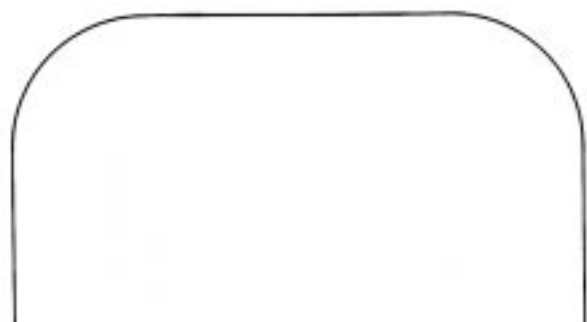

17.1278C
330 x 75 mm



17.1279C
330 x 100 mm



DEAVER
17.1270
180 x 19 cm

DEAVER
17.1271
215 x 22 mm

DEAVER
17.1272
230 x 25 mm

DEAVER
17.1273
300 x 25 mm

DEAVER
17.1274
330 x 25 mm

DEAVER
17.1275
360 x 25 mm



DEAVER
17.1276 300 x 38 mm



DEAVER
17.1277 300 x 50 mm



DEAVER
17.1278 300 x 75 mm
17.1279 330 x 100 mm

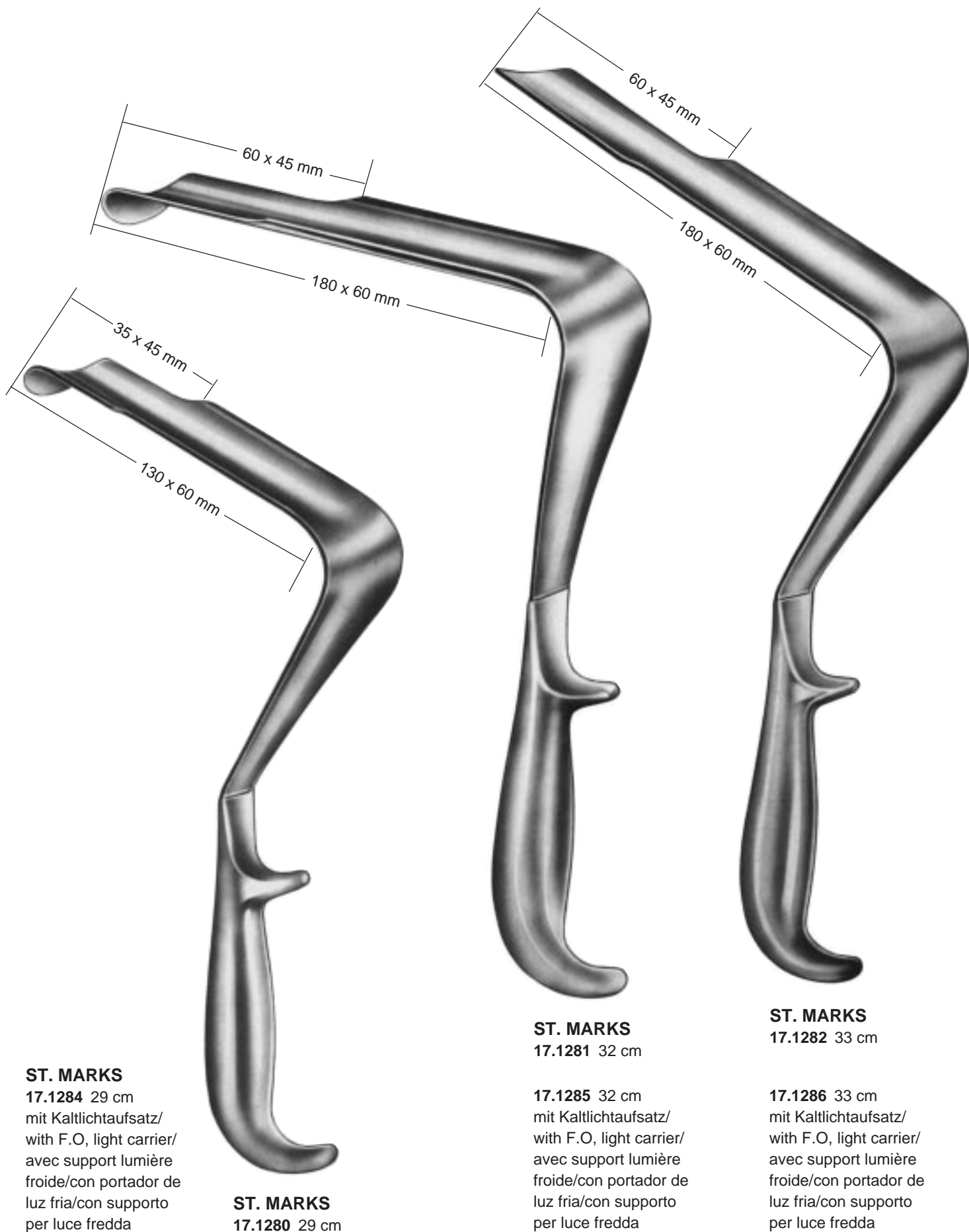

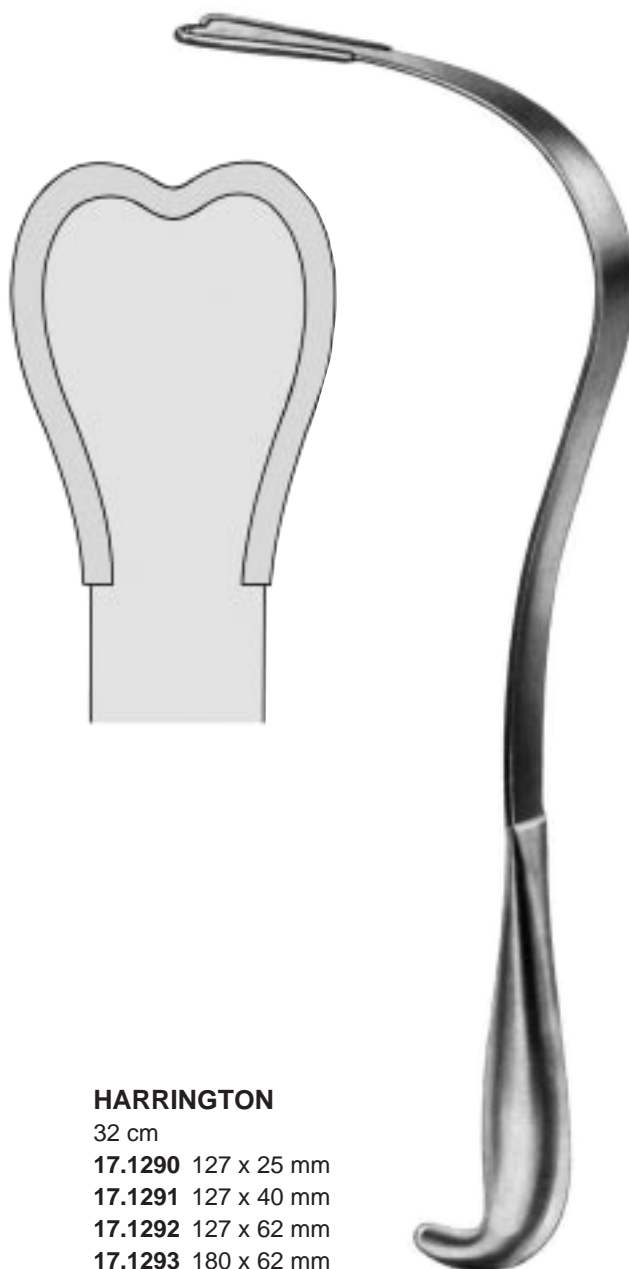

HARRINGTON

32 cm

17.1290 127 x 25 mm

17.1291 127 x 40 mm

17.1292 127 x 62 mm

17.1293 180 x 62 mm



HIBBS

17.1295 25 x 13 mm

17.1296 51 x 20 mm

17.1297 75 x 25 mm

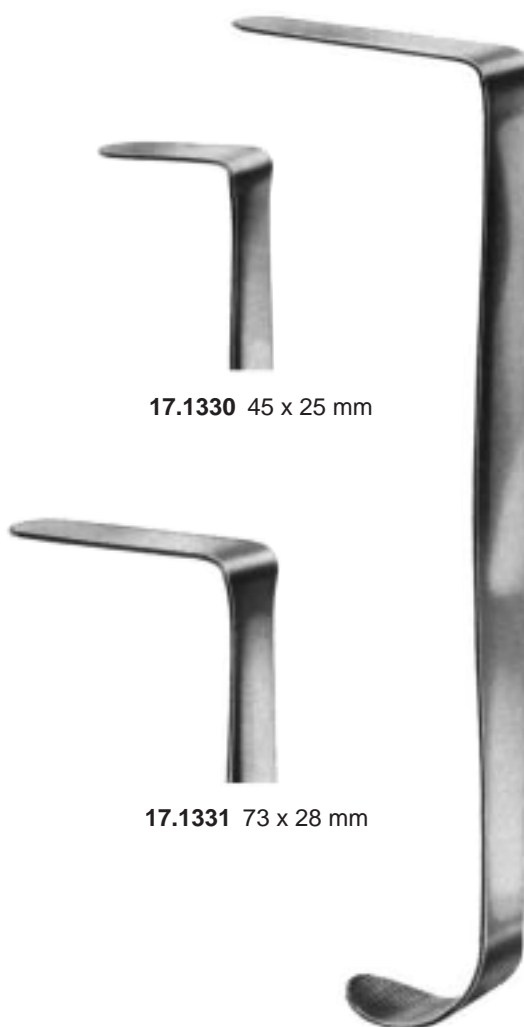

17.1330 45 x 25 mm

17.1331 73 x 28 mm

HEANEY

17.1332 27 cm

82 x 28 mm



ALLISON
17.1302 26 cm / 40 mm



ALLISON
17.1304 30 cm / 45 mm
17.1306 32 cm / 57 mm



ALLISON
17.1310 26 cm / 132 mm



DAVIDSON
17.1320 75 x 50 mm



DAVIDSON
17.1322 75 x 90 mm



POLLOSON
17.1400
27 cm



POLLOSON

17.1410

27 cm

gefenstert

fenestrated

a jouré

fenestrada

fenestrato

mit Kaltlichtaufsatz und Absaugung
with F.O. illumination and suction
avec support lumière froide et aspiration
con portador de luz fria y aspiración
con luce fredda e aspirazione



gezahnt
serrated
dentelé
dentada
dentate

17.3000	70 x 16mm
17.3002	70 x 25mm
17.3004	70 x 30mm
17.3006	70 x 36mm
17.3010	80 x 16mm
17.3012	80 x 25mm
17.3014	80 x 30mm
17.3016	80 x 36mm
17.3020	90 x 16mm
17.3022	90 x 25mm
17.3024	90 x 30mm
17.3026	90 x 36mm
17.3030	100 x 16mm
17.3032	100 x 25mm
17.3034	100 x 30mm
17.3036	100 x 36mm
17.3040	150 x 16mm
17.3042	150 x 25mm
17.3044	150 x 30mm
17.3046	150 x 36mm
17.3050	180 x 16mm
17.3052	180 x 25mm
17.3054	180 x 30mm
17.3056	180 x 36mm
17.3060	190 x 16mm
17.3062	190 x 25mm
17.3064	190 x 30mm
17.3066	190 x 36mm

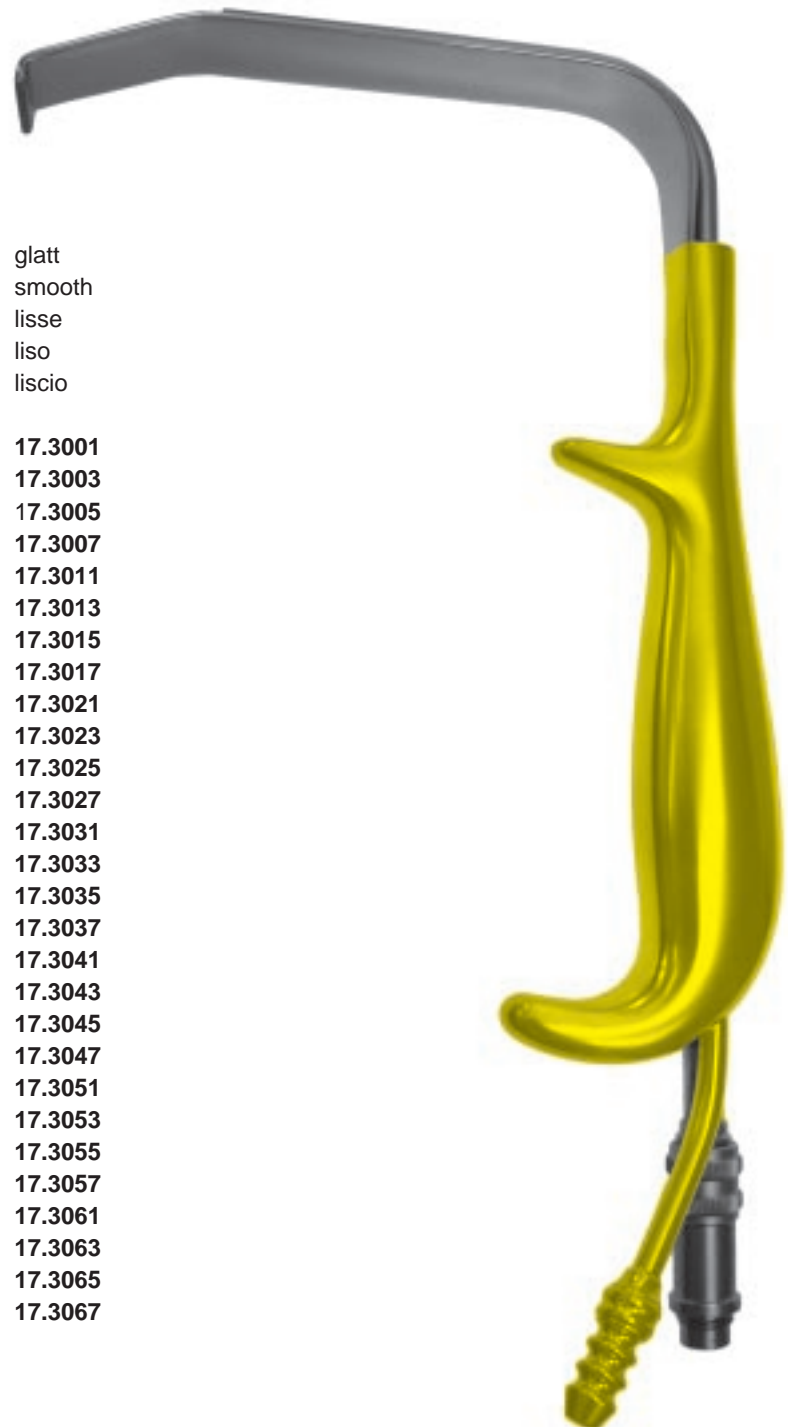

glatt
smooth
lisse
liso
liscio

17.3001	
17.3003	
17.3005	
17.3007	
17.3011	
17.3013	
17.3015	
17.3017	
17.3021	
17.3023	
17.3025	
17.3027	
17.3031	
17.3033	
17.3035	
17.3037	
17.3041	
17.3043	
17.3045	
17.3047	
17.3051	
17.3053	
17.3055	
17.3057	
17.3061	
17.3063	
17.3065	
17.3067	

SCULPO



23.0251 6x10mm



23.0252 11x18mm



23.0253 12x21mm



23 cm



LAMBOTTE
23.0255
27 cm



LANE-TRETHOWAN
23.0330
21,5 cm



LANE
23.0332
25 cm



AUFRANC

- 23.0360** spitz gerieft/sharp serrated/
pointu strié/agudo estriado / acuto con strie
- 23.0361** spitz glatt/sharp smooth/
pointu lisse/agudo liso / acuto liscio
- 23.0362** stumpf gerieft/blunt serrated/
mousse strié/romo estriado / smussa con strie
- 23.0363** stumpf glatt/blunt smooth/
mousse lisse/romo liso / smusso liscio

26 cm / 32 mm



SMILLIE
14 cm

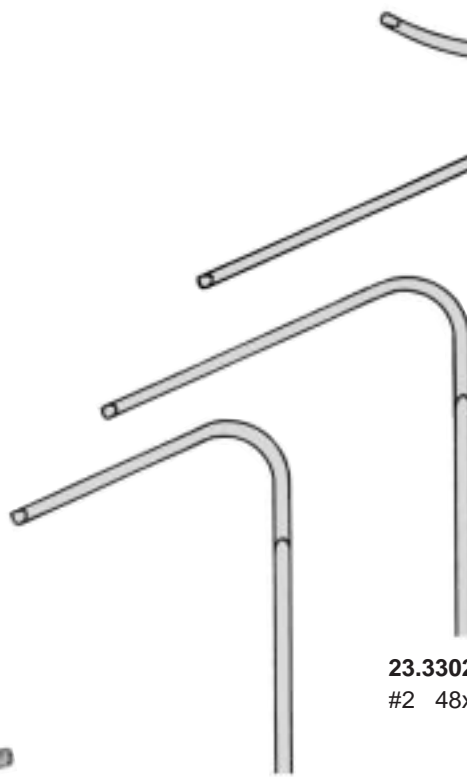

23.3301
#1 32x19 mm

23.3302
#2 48x19 mm

23.3303
#3 57x19 mm

23.3304
#4 52x13 mm

23.3305
#5 17x13 mm



40x4 mm

BLOUNT
23.3310
18 cm



38 x 9 mm

23.3312
21 cm

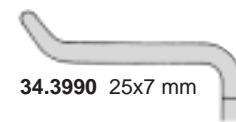
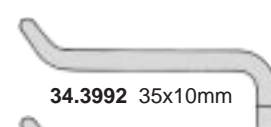
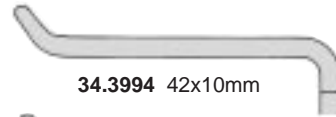
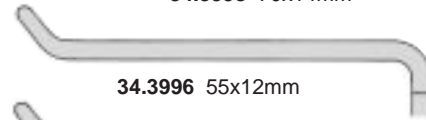
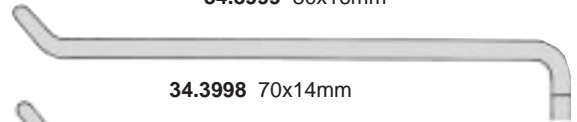
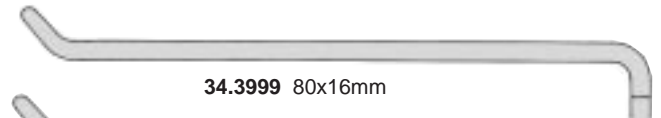
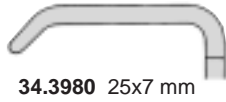
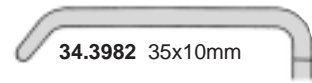
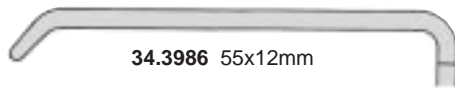
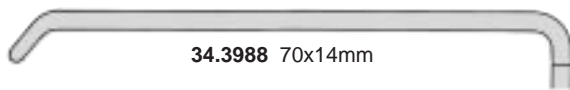
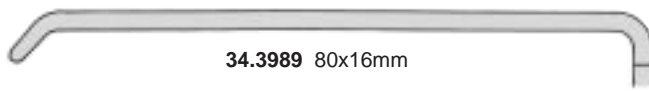

Weichteilehaken
 Soft Tissue Retractors
 Ecarteurs pour parties molles
 Separadores para partes blandas
 Divaricatori per tessuti molli



OBWEGESER
 34.3980-34.3989
 22 cm



OBWEGESER
 34.2990-34.3999
 22 cm

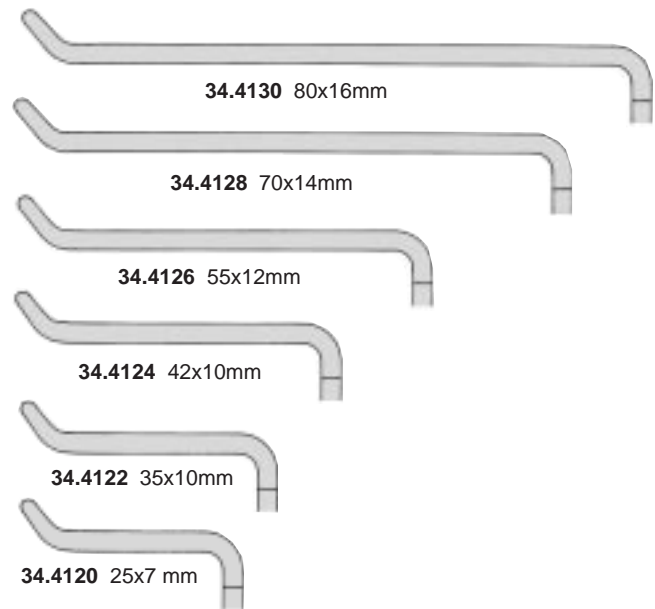
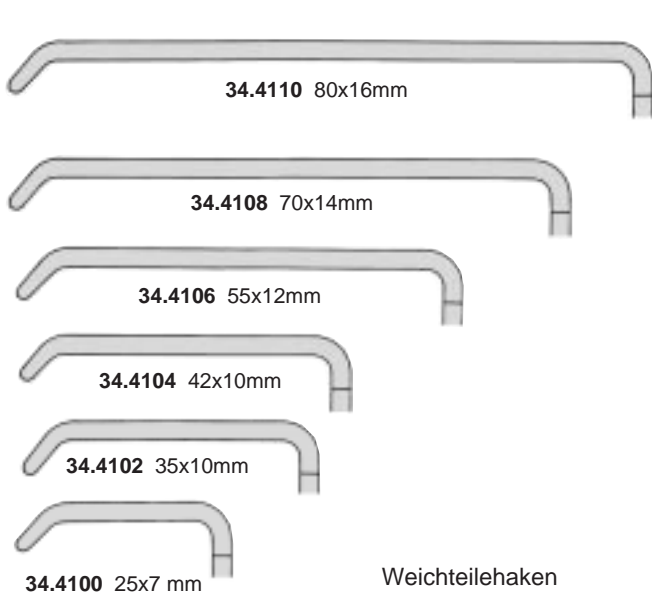

Weichteilehaken
Soft Tissue Retractors
Ecarteurs pour parties molles
Separadores para partes blandas
Divaricatori per tessuti molli



OBWEGESER
34.4100-34.4110
22 cm



OBWEGESER
34.4120-34.4130
22 cm

Wangenhaken
 Cheek Retractors
 Ecarteurs de joues
 Separadores de mejillas
 Divaricatori delle guance



34.0070
19 cm

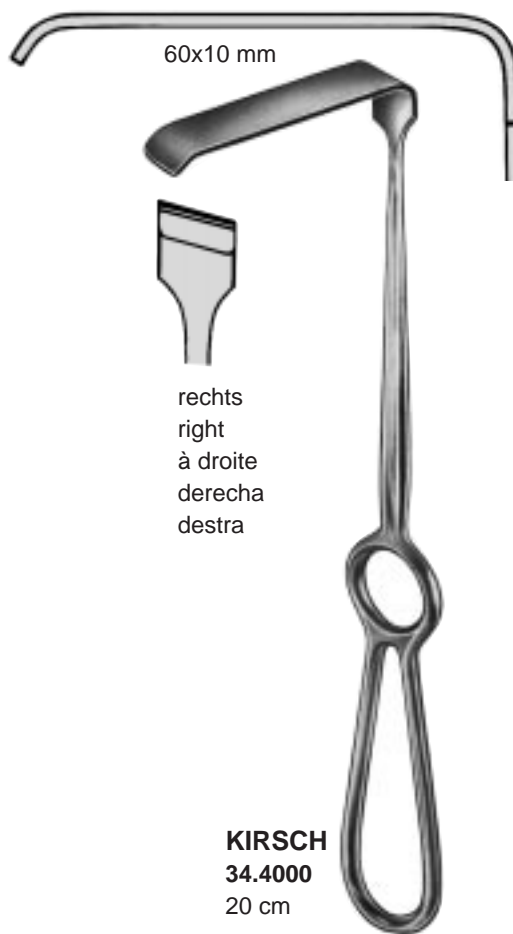

60x10 mm

rechts
right
à droite
derecha
destra

KIRSCH
34.4000
20 cm

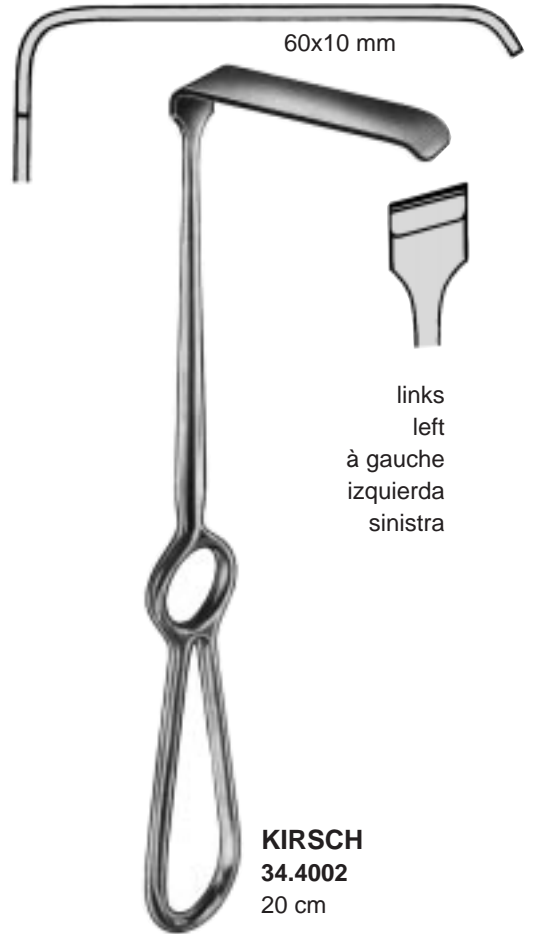

60x10 mm

links
left
à gauche
izquierda
sinistra

KIRSCH
34.4002
20 cm



34.4020
40x12 mm



34.4022
55x14 mm



DOCKHORN
20 cm



rechts
right
à droite
derecho
destra

STEINHÄUSER
34.4040 24,5 cm



links
left
à gauche
izquierdo
sinistra

STEINHÄUSER
34.4042 24,5 cm

Zygoma-Wundhaken
 Zygomatic Retractor
 Ecarteur cygomatique
 Separador cigomático
 Divaricatore per zigoma

Ramushaken
Ramus Retractors
Ecarteurs pour ramus
Separadores para el ramo
Separatore per ramo

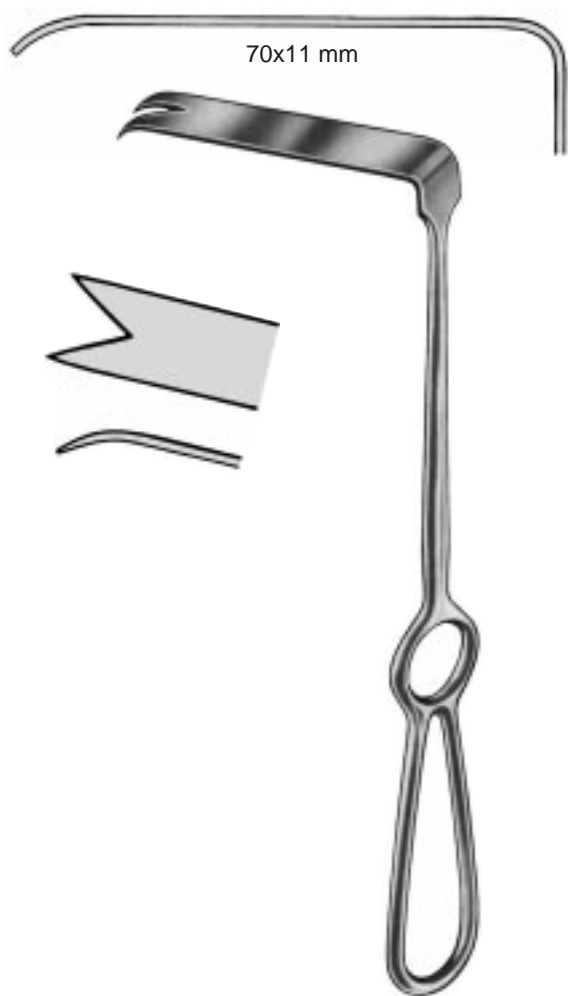

OBWEGESER
34.4140 22 cm

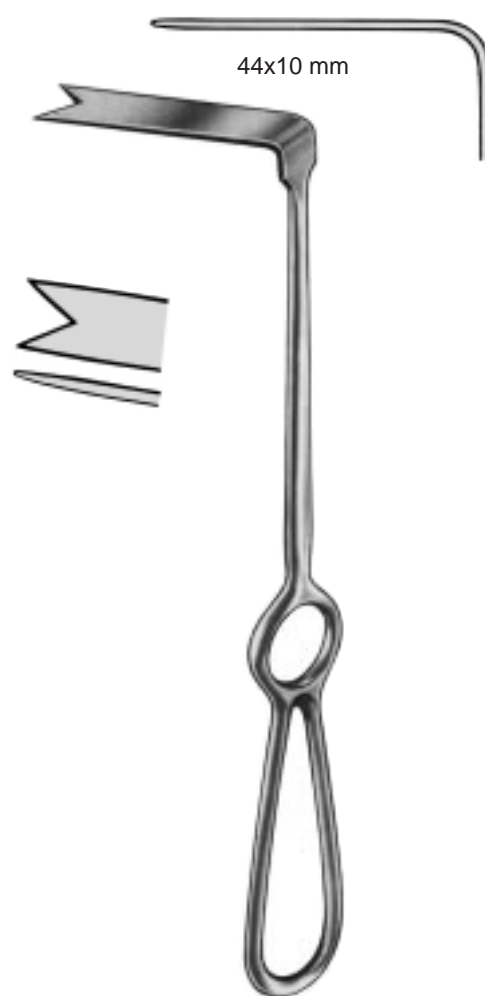

OBWEGESER
34.4145 22 cm

Ramushaken
Ramus Retractors
Ecarteurs pour ramus
Separadores para el ramo
Separatore per ramo



BÜCHS
34.4030
20,5 cm



38x18 mm



11x15x70 mm

OBWEGESER
34.3146 22 cm



RAMUS
16 cm



34.4150
20 mm



34.4152
25 mm



34.4154
30 mm

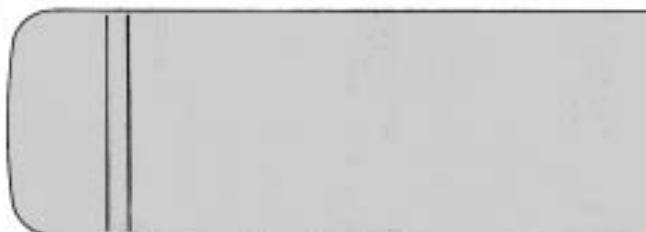

34.4156
35 mm

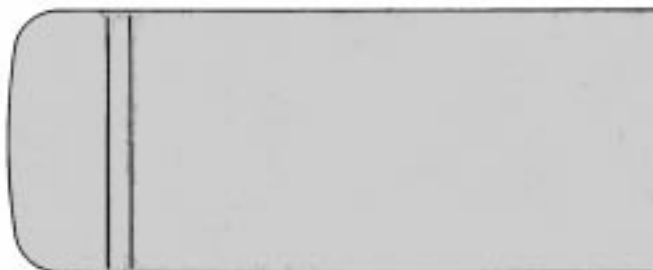

Kinnhalter
Chin Retractor
Fixe-menton
Gancho de mentón
Guancio per mento



OBWEGESER
34.4160
15 cm

Progenierinnen
Channel Retractors
Ecarteurs mandibulaires
Separadores mandibulares
Separatori mandibolari



OBWEGESER
34.4170 8 mm
34.4172 10 mm
16 cm

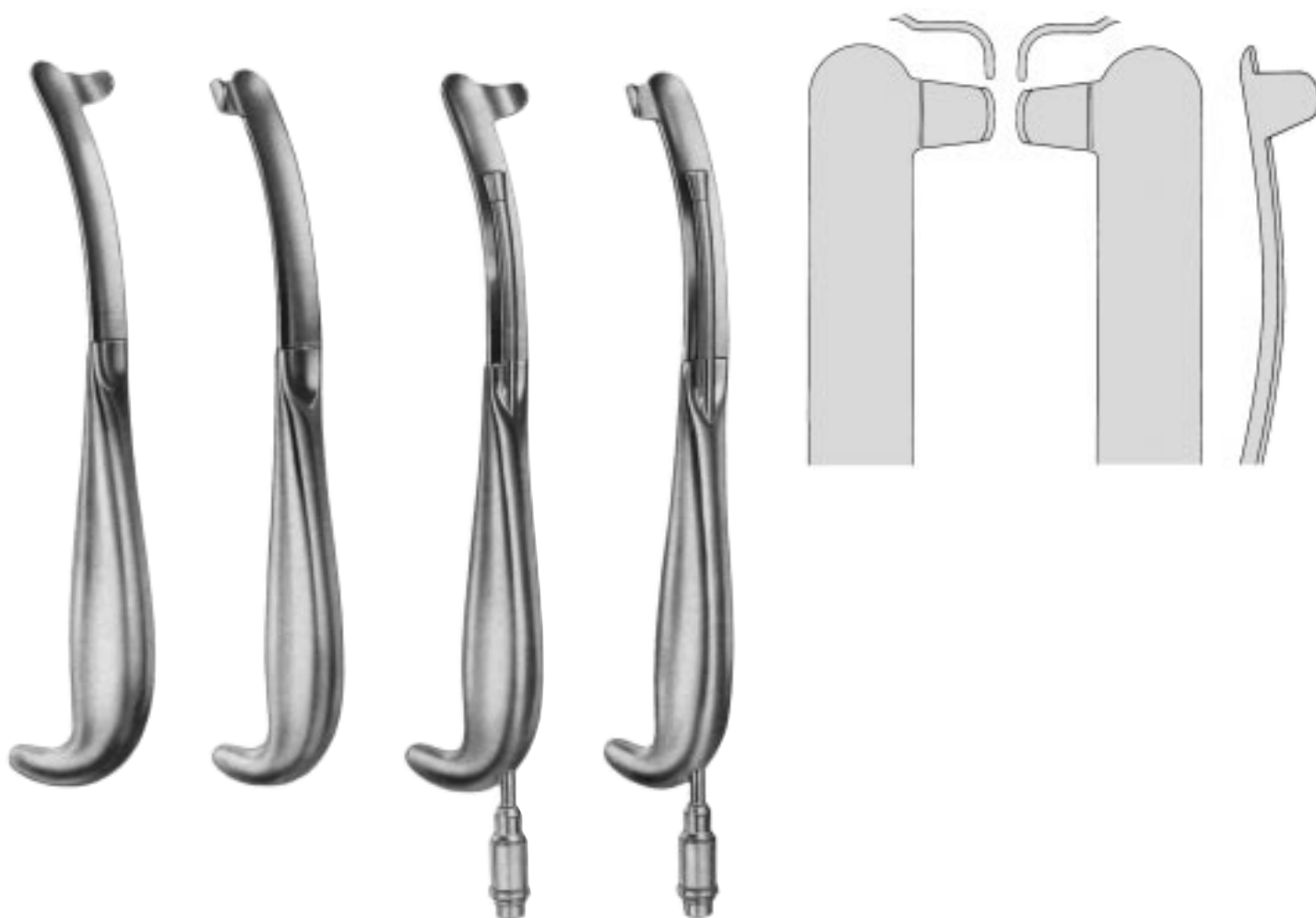

BAUER

34.4200

21 cm
26 / 16 mm
rechts
right
à droite
derecha
destra

BAUER

34.4202

21 cm
26 / 16 mm
links
left
à gauche
izquierda
sinistra

BAUER

34.4205

21 cm
26 / 16 mm
rechts
right
à droite
derecha
destra

BAUER

34.4207

21 cm
26 / 16 mm
links
left
à gauche
izquierda
sinistra

mit Kaltlichtaufsatz / with F.O. illumination /
avec support lumière froide /
con portador de luz fria / con luce fredda



INTRA ORAL
34.4220
24 cm
25 mm



INTRA ORAL
34.4225
24 cm
25 mm

mit Kaltlichtaufsatz
with F.O. illumination
avec support lumière froide
con portador de luz fria
con illuminazione alogena

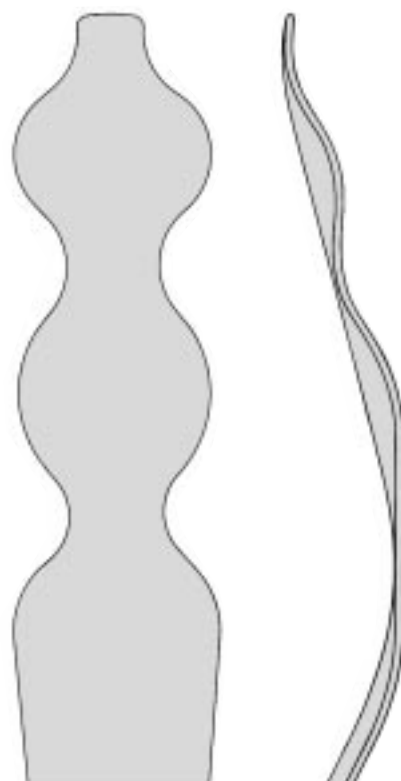



EXTRA ORAL
34.4210
24 cm
9,5 / 16 mm



EXTRA ORAL
34.4215
24 cm
9,5 / 16 mm
mit Kaltlichtaufsatz
with F.O. illumination
avec support lumière froide
con portador de luz fria
con illuminazione alogena

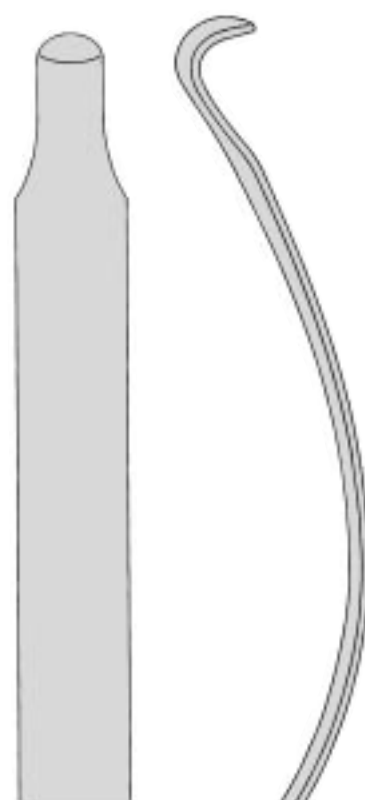

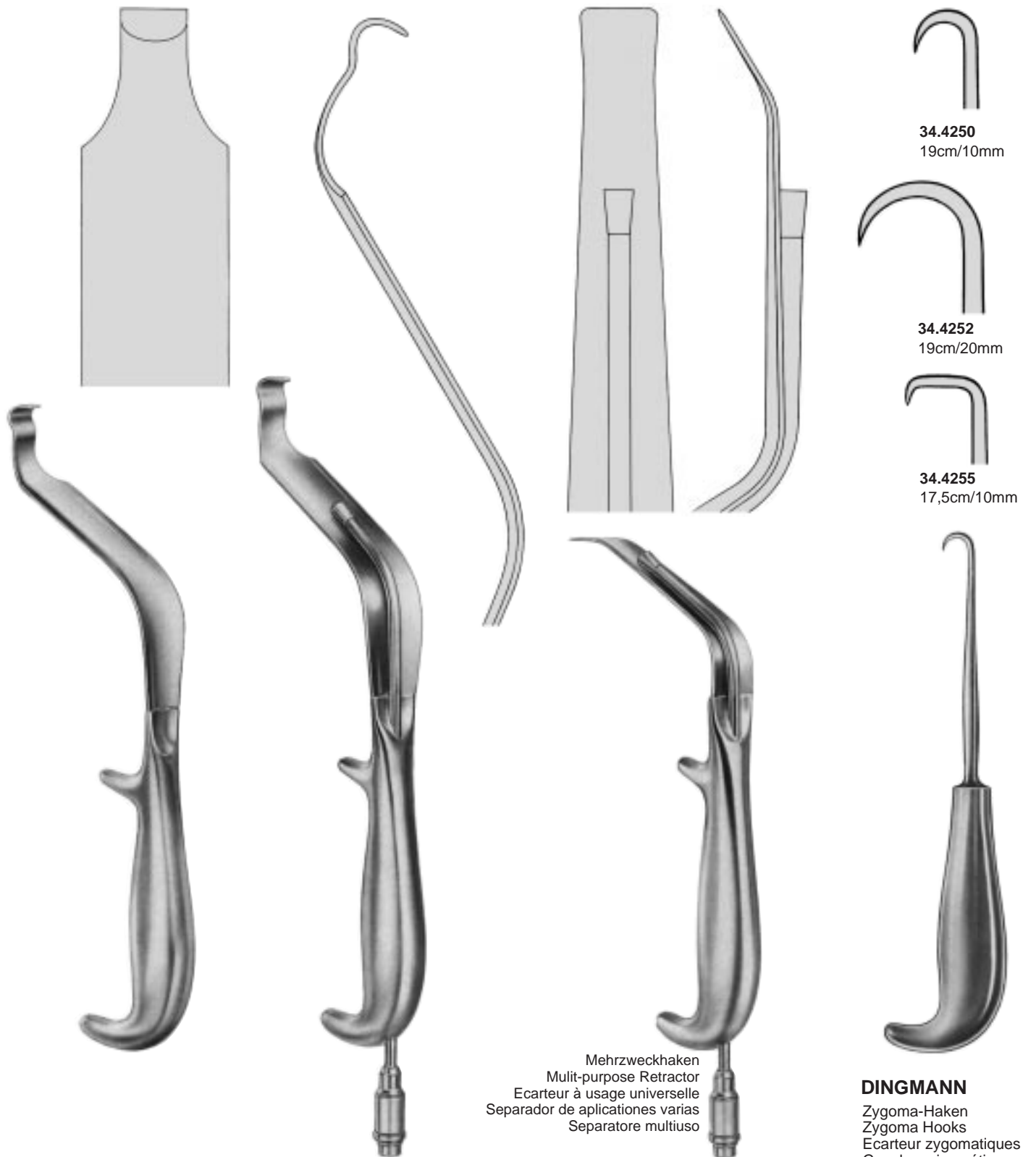

LeVASSEUR-MERRILL

34.4260 25 cm
12,5 / 27 mm

LeVASSEUR-MERRILL

34.4265 25 cm, 12,5 / 27 mm
mit Kaltlichtaufsatz
with F.O. illumination
avec support lumière froide
con portador de luz fria
con illuminazione alogena

SHEA

34.4275 24 cm, 14,5 mm
mit Kaltlichtaufsatz
with F.O. illumination
avec support lumière froide
con portador de luz fria
con illuminazione alogena

DINGMANN

Zygoma-Haken
Zygoma Hooks
Ecarteur zygomatiques
Ganchos zigomáticos
Divaricatore per zigoma

Mehrzweckhaken
Mult-purpose Retractor
Ecarteur à usage universelle
Separador de aplicaciones varias
Separatoro multiuso

34.4250
19cm/10mm

34.4252
19cm/20mm

34.4255
17,5cm/10mm

Atriumhaken
Atrium Retractors
Ecarteurs pour Atrium
Separadores para atrio
Divaricatori per atrio



BOROWSKI
27 cm



40.0381
17x21 mm



40.0382
16x23 mm



40.0383
20x25 mm



40.0384
24x27 mm



40.0385
28x20 mm



40.0386
28x29 mm

Atriumhaken
Atrium Retractors
Ecarteurs pour Atrium
Separadores para atrio
Divaricatori per atrio



rechts
right
à droite
a derecha
destra

COOLEY
40.0410
21,5 cm



rechts
right
à droite
a derecha
destra

gezahnt
serrated
dentées
dentadas
dentate

COOLEY
40.0411
21,5 cm



links
left
à gauche
a izquierda
sinistra

COOLEY
40.0412
23 cm

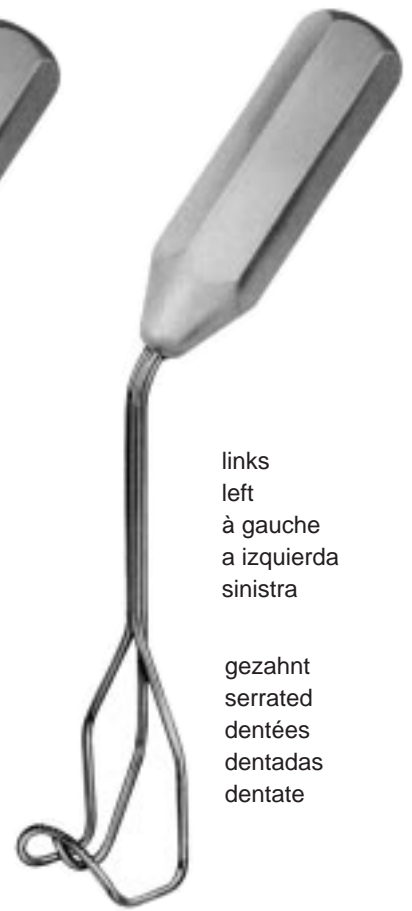

links
left
à gauche
a izquierda
sinistra

gezahnt
serrated
dentées
dentadas
dentate

COOLEY
40.0413
23 cm



CRAWFORD
19 cm

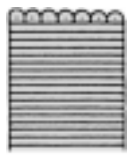

40.0400
15 x 15 mm

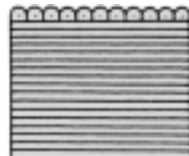

40.0402
15 x 23 mm

Aortahaken
 Aorta Retractors
 Ecarteurs pour Aorta
 Separadores para aorta
 Divaricatori per aorta



ROSS
40.0391-40.0396
27 cm



40.0391
Fig. 1



40.0392
Fig. 2



40.0393
Fig. 3



40.0394
Fig. 4



40.0395
Fig. 5



40.0396
Fig. 6

WUNDSPEIZER
RETRACTORS, SELF-RETAINING
ECARTEURS AUTOSTATIQUES
SEPARADORES AUTOSTATICOS
DIVARICATORI AUTOSTATICI





BARRAQUER
30.0003
 30 mm
 Kinder
 children
 enfants
 niños
 bambini

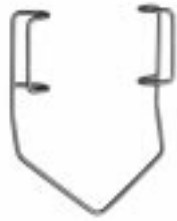

BARRAQUER
30.0004
 40 mm
 Erwachsene
 adults
 adultes
 adultos
 adulti



BARRAQUER
30.0005
 40 mm



BOWMAN
30.0007
 7 cm



30.0008
 5 cm
 Öffnung 35 mm
 opening 35 mm
 ouverture 35 mm
 apertura 35 mm
 apertura 35 mm



SMITH
30.0010
 5 cm



CRITCHETT
30.0020
 6 cm



CLARKE
30.0030
 8 cm



GRAEFE
30.0040 6 cm
30.0042 9 cm



WEISS
30.0050
 8 cm



SAUER
30.0060
 6 cm



ARRUGA
30.0070
 7 cm



ARRUGA
30.0072
 7 cm



MURDOCK
30.0076
 5 cm



**MELLINGER-
 AXENFELD**
 30.0080
 7 cm



**MELLINGER-
 AXENFELD**
 30.0082
 7 cm



MELLINGER
 30.0084 5 cm
 Kinder/children
 enfants /niños/bambini
 30.0085 7 cm
 Erwachsene/adults
 adultes/adultos/adulti



LISTER-BURCH
 30.0090
 8 cm



WILLIAMS
 30.0094 7 cm
 30.0095 8 cm



LANCASTER
 30.0100
 7 cm



ZIEGLER
 30.0110
 7 cm



PLEY
 30.0115
 6 cm



CASTROVIEJO
 30.0120
 8 cm



PARK
 30.0130
 8 cm



PARK-GUYTON
 30.0135
 8 cm



PARK-MAUMENEE
 30.0136
 8 cm



MUELLER
 30.0140
 7 cm



STEVENSON
 30.0150
 7 cm



GOLDSTEIN
30.0160
3 cm



GOLDSTEIN-MINI
30.0162
3 cm



AGRICOLA
30.0170



COOK
30.0181 3 cm
Kinder/children
enfants /niños/bambini
30.0182 5 cm
Erwachsene/adults
adultes/adultos/adulti



LIEBERMANN
30.0190 8 cm
"K"-form/"K"-shaped/
forme "K"/forma "K"/
forma "K"



LIEBERMANN
30.0191 8 cm
"V"-form/"v"-shaped/
forme "V"/forma "V"/
forma "V"



LIEBERMANN
30.0192 8 cm
Kinder/children/
enfants /niños/bambini



LIEBERMANN
30.0193 8 cm
Erwachsene/adults/
adultes/adultos/adulti



FINSEN



17.5000 5 cm
 spitz
 sharp
 pointu
 agudo
 appuntato



17.5001 5 cm
 stumpf
 blunt
 mousse
 romo
 smusso



17.5002 7 cm
 spitz
 sharp
 pointu
 agudo
 appuntato

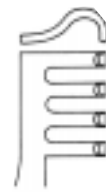

17.5003 7 cm
 stumpf
 blunt
 mousse
 romo
 smusso



FINSEN



17.5006 7 cm
 spitz
 sharp
 pointu
 agudo
 appuntato



17.5007 7 cm
 stumpf
 blunt
 mousse
 romo
 smusso



WUNDSPREIZER

17.5008 8 cm
17.5009 11 cm



BOSE

36.0120 7 cm
 Tracheal-Wundspreizer/
 Trachea Retractor/
 Ecarteur trachéal/
 Retractor traqueal/
 Divaricatore tracheale



ALM



spitz
 sharp
 pointu
 agudo
 appuntato
17.5010 7 cm



stumpf
 blunt
 mousse
 romo
 smusso
17.5011 7 cm

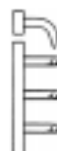

spitz
 sharp
 pointu
 agudo
 appuntato
17.5012 10 cm



stumpf
 blunt
 mousse
 romo
 smusso
17.5013 10 cm



ALM
17.5015
 7 cm / 5,5 mm
 stumpf
 blunt
 mousse
 romo
 smusso



ALM
17.5017
 7 cm / 16 mm
 stumpf
 blunt
 mousse
 romo
 smusso



ALM
17.5019
 10 cm / 15 mm



HOLTZHEIMER
17.5020 10 cm
 scharf/sharp/pointu/
 agudo/appuntato
17.5021 10 cm
 stumpf/blunt/mousse/
 romo/smusso



EPICARDIAL

- 17.5030** 0,6N
- 17.5031** 1,2N
- 17.5032** 1,8N

Epicardial Spreizer, 4 cm, stumpf, 8x11 mm,
 25 mm Spreizweite, Gewicht 1 gr., TITAN

Epicardial Spreader 4 cm, blunt, 8x11 mm,
 spread 25 mm, weight 1 gr., TITANIUM

Epicardial Ecarteur, 4 cm, mousse, 8x11 mm,
 ouverture 25 mm, poids 1 gr., TITANE

Epicardial Separadore, 4 cm, romo, 8x11 mm,
 apertura 25 mm, peso 1 gr., TITANIO

Epicardial DIVARICATORE, 4 cm, smusso, 8x11 mm,
 apertura 25 mm, peso 1 gr., TITANIO



JANSEN



17.5100 10.5 cm
 spitz
 sharp
 pointu
 agudo
 appuntato

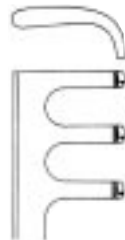

17.5101 10.5 cm
 stumpf
 blunt
 mousse
 romo
 smusso



ALLPORT
17.5150 10 cm

geriefte Valven
 Serrated blades
 valves striées
 valvas estriadas
 Valva con striatura

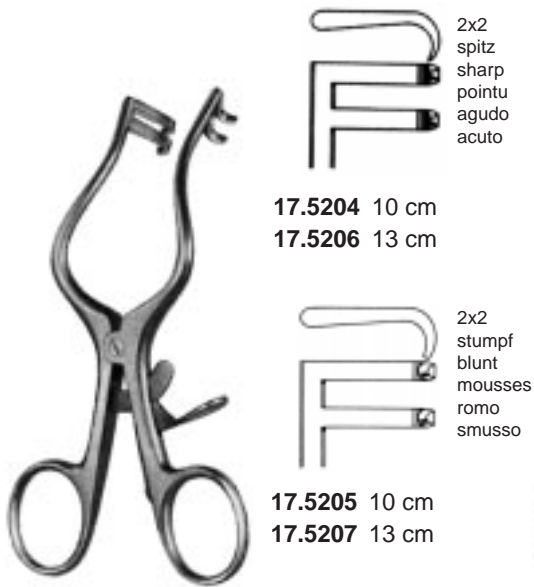

17.5204 10 cm
 17.5206 13 cm

2x2
 spitz
 sharp
 pointu
 agudo
 acuto

2x2
 stumpf
 blunt
 mouses
 romo
 smusso

17.5205 10 cm
 17.5207 13 cm

PLESTER

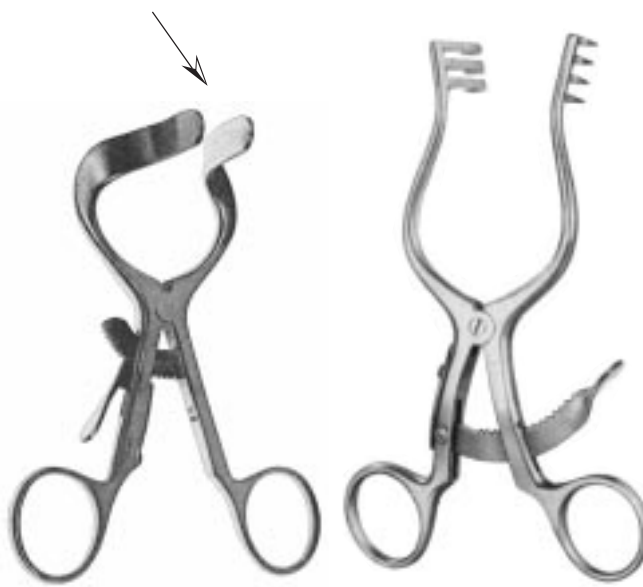

COX
 17.5210
 12 cm

für Finger und Zehen
 Finger- and Toe Retractor
 pour doigts et orteils
 para dedos
 per dita e piede

SCALP-CONTOUR
 14 cm

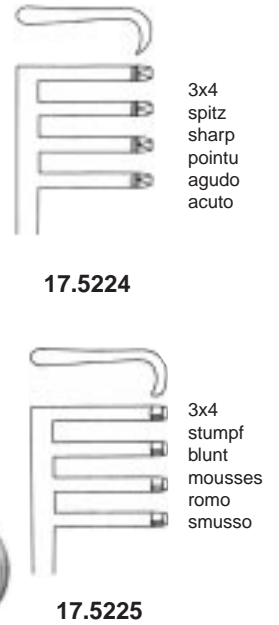

17.5224

17.5225

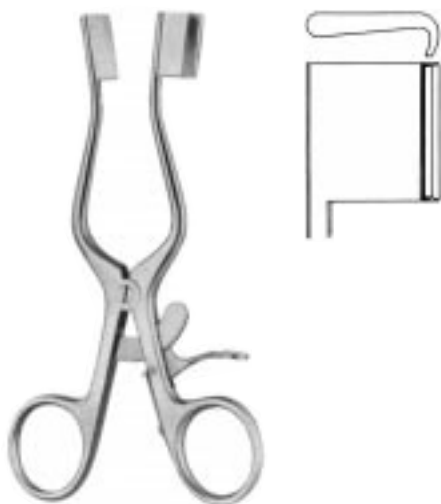

WEITLANER-BABY
 17.5290 14 cm



WEITLANER
 10,5 cm

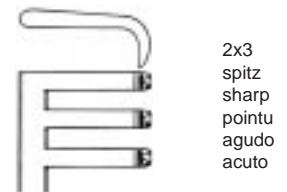

17.5300

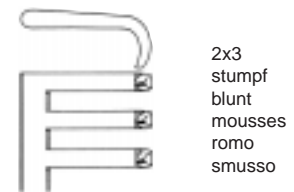

17.5301

2x3
 spitz
 sharp
 pointu
 agudo
 acuto

2x3
 stumpf
 blunt
 mouses
 romo
 smusso



WEITLANER



spitz
sharp
pointu
agudo
acuto

17.5302 14 cm
17.5304 16,5 cm



stumpf
blunt
mousses
romo
smusso

17.5303 14 cm
17.5305 16,5 cm



WEITLANER



spitz
sharp
pointu
agudo
acuto

17.5306 20 cm



stumpf
blunt
mousses
romo
smusso

17.5307 20 cm



WEITLANER

24 cm

17.5308 3x4 spitz/sharp/pointu/agudo/acuto 5x6 17.5310
 17.5309 3x4 stumpf/blunt/mousse/romo/smusso 5x6 17.5311



ADSON

19 cm

17.5320 4x4 spitz/sharp/pointu/agudo/acuto
 17.5321 4x4 stumpf/blunt/mousse/romo/smusso



ADSON
 26,5 cm

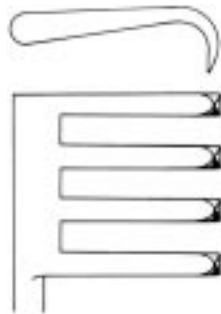

3x4
 spitz
 sharp
 pointu
 agudo
 acuto

17.5322

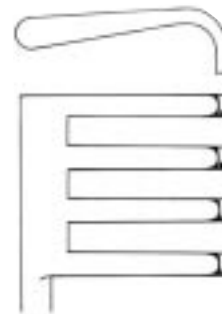

3x4
 stumpf
 blunt
 mousses
 romo
 smusso

17.5323

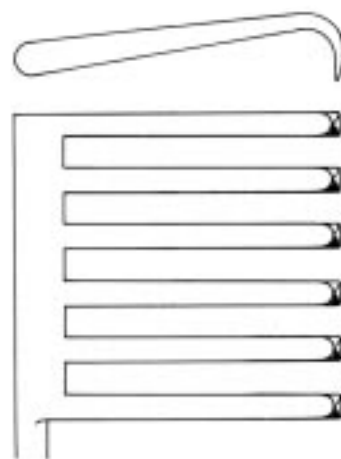

6x6
 spitz
 sharp
 pointu
 agudo
 acuto

17.5324

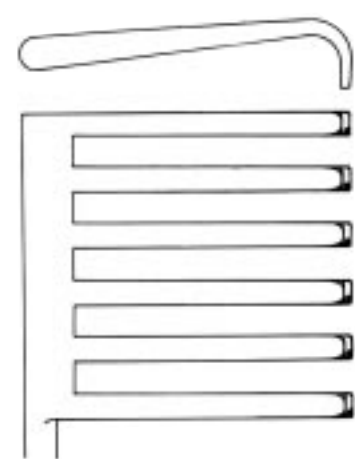

6x6
 stumpf
 blunt
 mousses
 romo
 smusso

17.5325



17.5330
 spitz/sharp/pointu/agudo/acuto

17.5331
 stumpf/blunt/mousse/romo/smusso

ANDERSON-ADSON
 20 cm



HEMILAMINEKTOMIE
28 cm

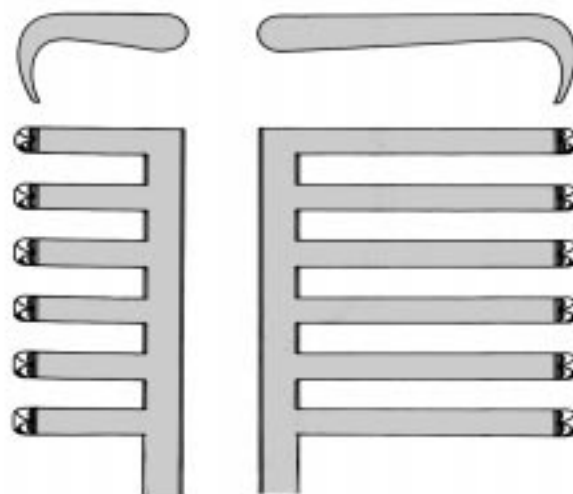

17.5328

spitz, lange Zähne links
sharp, long teeth on right side
pointu, griffes longues à droite
agudo, dientes largos a la derecha
acuto, denti lunghi a sinistra

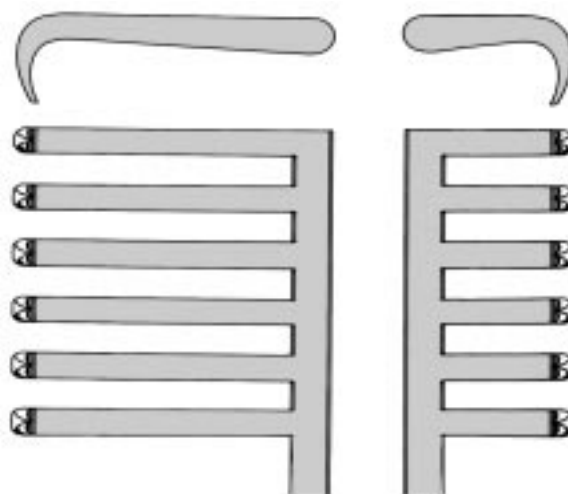

17.5329

32x14 mm
spitz, lange Zähne links
sharp, long teeth on left
pointu, griffes longues à gauche
agudo, dientes largos a la izquierda
acuto, denti lunghi a destra



CONE

25 cm

17.5332

spitz/sharp/pointu/agudo/acuto

17.5333

stumpf/blunt/mousse/romo/smusso



TRAVERS

20cm

17.5336

4x5 stumpf/blunt/mousse/romo/smusso



NORFOLK-NORWICH

17.5340

20 cm



WALTON
 17.5350 18 cm



WALTON
 17.5351 18 cm



WULLSTEIN



spitz
 sharp
 pointu
 agudo
 acuto

17.5400 10,5 cm
 17.5402 13,0 cm
 17.5404 16,0 cm



stumpf
 blunt
 mousses
 romo
 smusso

17.5401 10,5 cm
 17.5403 13,0 cm
 17.5405 16,0 cm



MOLLISON
 17.5406
 15 cm



MILLIGAN
 17.5410
 13 cm





SCHUKNECHT
17.5416
13 cm



PLESTER-R
17.5450
10,5 cm



PLESTER-L
17.5451
10,5 cm



PERKINS-R
17.5446
13 cm



PERKINS-L
17.5447
13 cm

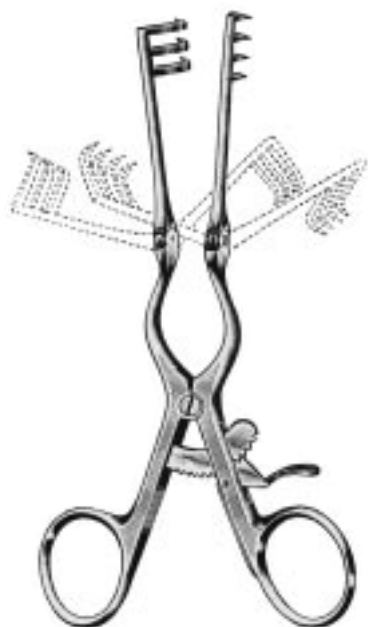

ADSON-BABY
 16 cm

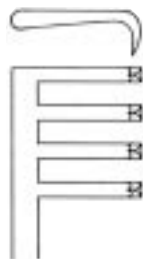

17.5612

3x4
 spitz
 sharp
 pointu
 agudo
 acuto



17.5613

3x4
 stumpf
 blunt
 mousses
 romo
 smusso



CLOWARD-CONTOUR

17.5460 13,5 cm

1x1 spitz / sharp / pointu / agudo / acuto

17.5461 13,5 cm

1x1 stumpf / blunt / mousse / romo / smusso



CLOWARD-CONTOUR

17.5462 13,5 cm

3x3 spitz / sharp / pointu / agudo / acuto

17.5463 13,5 cm

3x3 stumpf / blunt / mousse / romo / smusso



CHARNLEY
17.5590
28 cm
Horizontalspreizer
Horizontal Spreader
Ecarteur horizontal
Separador horizontal
Divaricatore orizzontale



SEXTON
17.5596
31 cm

spitz
 sharp
 pointu
 agudo
 acuto

stumpf
 blunt
 mousses
 romo
 smusso



17.5600
 14 cm

17.5601
 14 cm



17.5602
 16,5 cm

17.5603
 16,5 cm



17.5604
 20 cm

17.5605
 20 cm

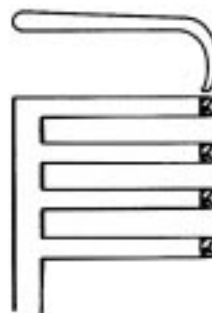
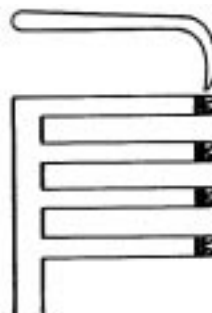

17.5606
 26 cm

17.5607
 26 cm



**BECKMANN-WEITLANER
 (ADSON, CONE)**

spitz
sharp
pointu
agudo
acuto

7x7
spitz
sharp
pointu
agudo
acuto



BECKMANN
17.5610 31 cm



BECKMANN-EATON
17.5620 32 cm

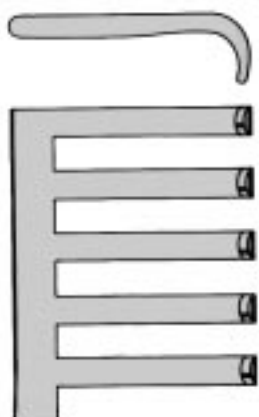

4x5
 stumpf
 blunt
 mousses
 romo
 smusso



spitz
 sharp
 pointu
 agudo
 acuto

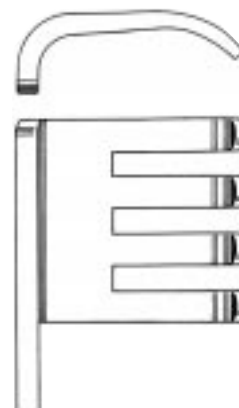

stumpf
 blunt
 mousses
 romo
 smusso

17.5635 25 mm

17.5636 25 mm



ADSON
 17.5632 32 cm



BECKMANN-ADSON
 31 cm

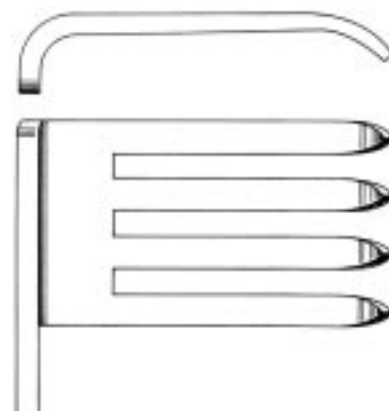

spitz
 sharp
 pointu
 agudo
 acuto

17.5637 44 mm

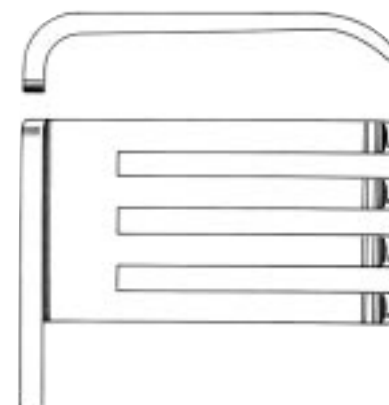

stumpf
 blunt
 mousses
 romo
 smusso

17.5638 44 mm

spitz
sharp
pointu
agudo
acuto

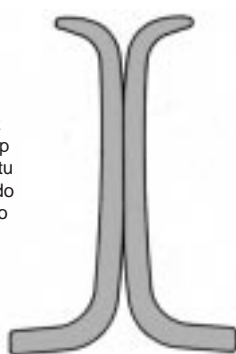

HARVEY-JACKSON
17.5640
28 cm

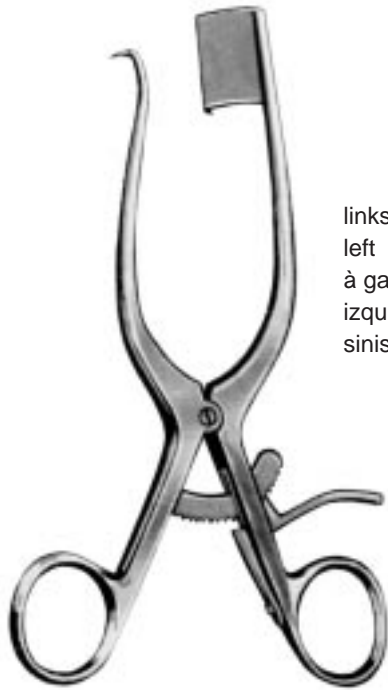

links
left
à gauche
izquierda
sinistra

MARKHAM-MEYERDING
17.5660 18 cm

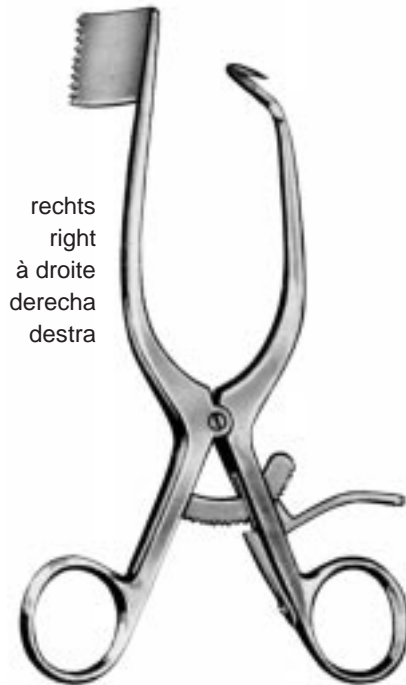

rechts
right
à droite
derecha
destra

MARKHAM-MEYERDING
17.5662 18 cm



MEYERDING
20 cm

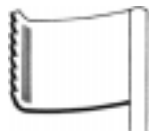

17.5665 32 x 25 mm



17.5666 54 x 25 mm



17.5667 60 x 19 mm



17.5668 60 x 25 mm

76x40 64x25 mm



DARLING
17.5670 18 cm

64x25 76x40 mm



DARLING
17.5672 18 cm



Kinder
children
enfants
niños
bambini

DEBAKEY-FEMUR
17.5890
10 cm



DEBAKEY-FEMUR
17.5892
14,5 cm



JOLL (FRIEDMANN)
55.0500
10 cm



GELPI-MINI
17.5899 10 cm



GELPI-BABY
17.5900 14 cm



GELPI
18 cm
17.5901 spitz / sharp / pointu / agudo / acuto
17.5902 stumpf / blunt / mousse / romo / smusso



GELPI
17.5905 18 cm



GELPI-SELETZ
17.5907 15 cm



JACKSON-BURROWS
17.5908 18,5 cm



MORRIS-MITRAL
40.3400
16 cm



GELPI-ORTHO
17.5906
30 cm

Gefäßwundspreizer
Vascular Retractor
Ecarteur vasculaire
Separador vascular
Divaricatore vascolar



TUEBINGEN
 17.5910 16,5 cm



RIGBY
 17.5930 18 cm
 60 x 20 mm



RIGBY
 17.5932 18 cm
 35 x 20 mm



HENLEY
 16,5 cm
 mit Mittelvalven
 with center blades
 avec valves centrales
 con valvas centrales
 con valve centrale



17.5980



17.5982

17.5985 - 17.5987
 17.5985 - 17.5987
 17.5985 - 17.5987
 17.5985 - 17.5987
 17.5985 - 17.5987



17.5985
 16 x 20 mm



17.5986
 16 x 25 mm



17.5987
 16 x 30 mm

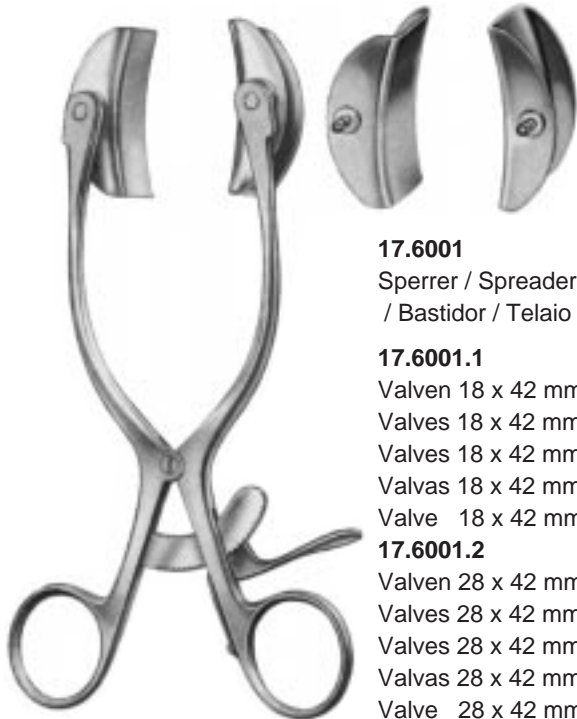

17.6001
 Sperrer / Spreader / Cadre
 / Bastidor / Telaio

17.6001.1
 Valven 18 x 42 mm (Paar)
 Valves 18 x 42 mm (Pair)
 Valves 18 x 42 mm (Paire)
 Valvas 18 x 42 mm (Par)
 Valve 18 x 42 mm (Paio)

17.6001.2
 Valven 28 x 42 mm (Paar)
 Valves 28 x 42 mm (Pair)
 Valves 28 x 42 mm (Paire)
 Valvas 28 x 42 mm (Par)
 Valve 28 x 42 mm (Paio)

COLLIN-BABY

17.6000 18 cm

bestehend aus:

- 17.6001 Rahmen
- 17.6001.1 1 Paar Valven 18x42 mm
- 17.6001.2 1 Paar Valven 28x42 mm

consisting of:

- 17.6001 Frame
- 17.6001.1 Blades 18x42 mm (Pair)
- 17.6001.2 Blades 28x42 mm (Pair)

comprenant:

- 17.6001 cadre seul
- 17.6001.1 valves 18x42 mm (paire)
- 17.6001.2 valves 28x42 mm (paire)

compuesto de:

- 17.6001 bastidor suelto
- 17.6001.1 valvas 18x42 mm (par)
- 17.6001.1 valvas 28x42 mm)

composto da:

- 17.6001 Telaio solo
- 17.6001.1 valve 18x42mm (par)
- 17.6001.2 valve 28x42 mm (par)



COLLIN
17.6002 22 cm
 38 x 60 mm

Valven / Lateral blades / valves
 latÉrales / valvas laterales /
 valve laterali 38 x 60 mm



COLLIN
 22 cm
17.6003

Seitenvalven / Lateral blades / valves
 latÉrales / valvas laterales / valve
 laterali 38 x 60 mm

Mittelvalve / center blade / valve
 central / valva centrale / valva
 centrale 38 x 55 mm

17.6004
 Seitenvalven / Lateral blades / valves
 latÉrales / valvas laterales / valve
 laterali 38 x 80 mm

Mittelvalve / center blade / valve
 central / valva centrale / valva
 centrale 50 x 75 mm



COLLIN-LOCKTITE

17.6007 26 cm

60 x 80 mm

Seitenvalven / Lateral blades /
valves latérales / valvas laterales /
valve laterali 60 x 80 mm

Mittelvalve / center blade /
valve central / valva centrale /
valva centrale 60 x 75 mm

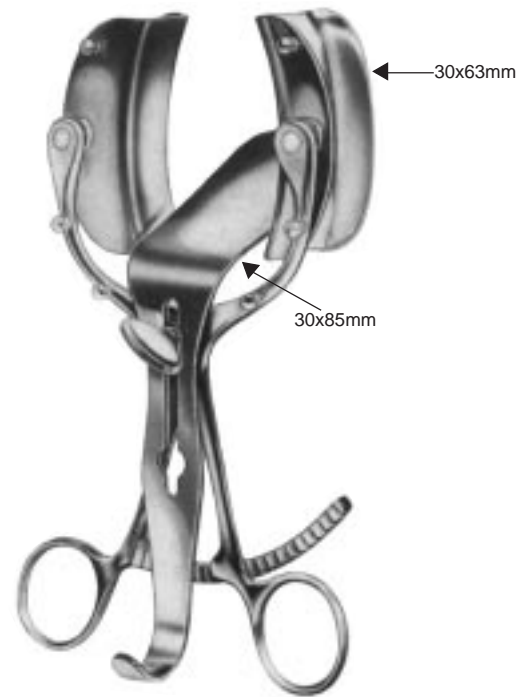

LEGUEU

17.6010 18 cm



MAYO-ADAMS

17.6015 17 cm



HOLZBACH
 17.6020



RICARD

17.6030 28 cm

Mittelvalve 55x70mm, Seitenvlaven 50x58mm
 Centervalve 55x70, lateral blades 50x58 mm
 valve centrale 55x70, valves laterales 50x58mm
 valva central 55x70, valvas laterales 50x58mm
 valva centrale 55x70, valve laterali 50x58mm

17.6035 30 cm

Mittelvalve 80x90mm, Seitenvlaven 60x80mm
 Centervalve 80x90, lat. blades 60x80 mm
 valve centrale 80x90, valves laterales 60x80mm
 valva central 80x90, valvas laterales 60x80mm
 valva centrale 80x90, valve laterali 60x80mm

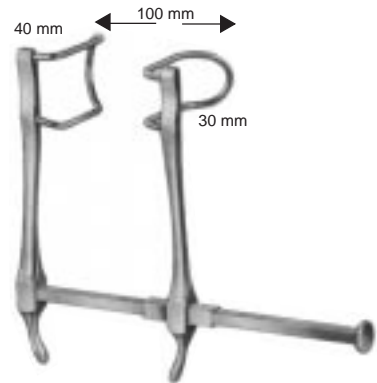

GOSSET
 17.6100 100 mm

ROBIN-MASSE

17.6040 21cm

Mittelvalve 40x64mm, Seitenvlaven 38x62mm
 Centervlaven 40x64, lat. blades 38x62 mm
 valve centrale 40x64, valves laterales 38x62mm
 valva central 40x64, valvas laterales 38x62mm
 valva centrale 40x64, valve laterali 38x62mm

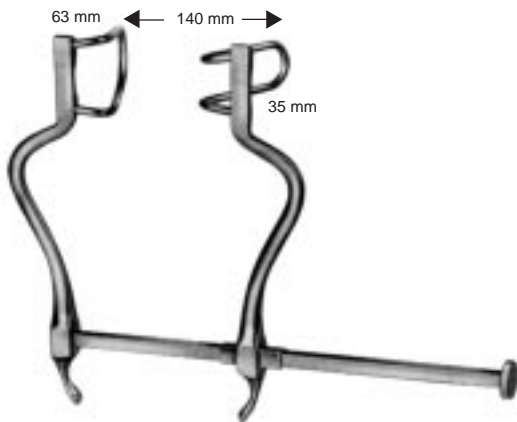

GOSSET
 17.6101 140mm

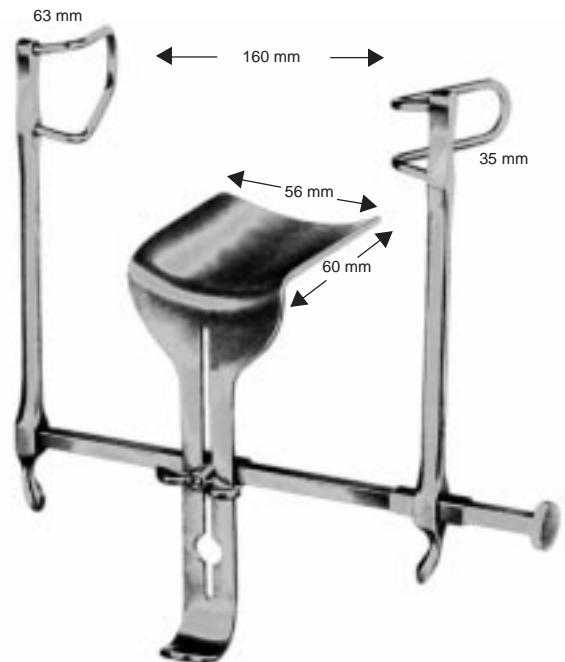

GOSSET
 17.6102 160mm

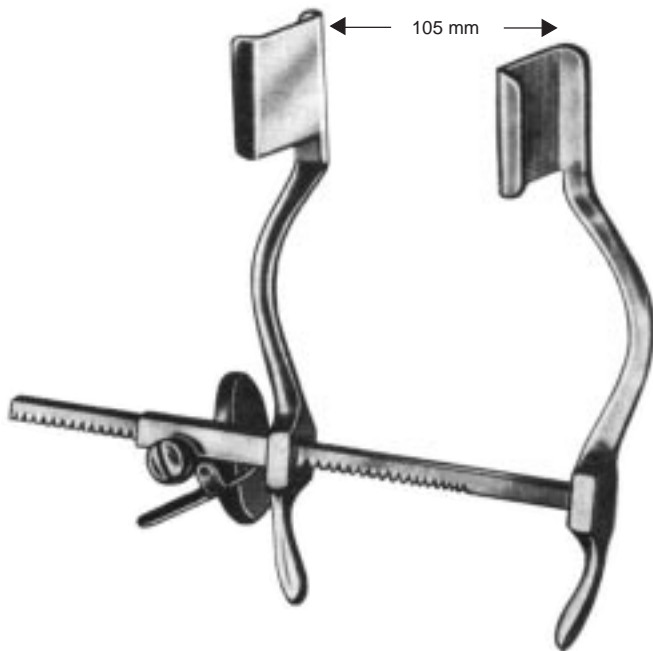

HERTZLER
 17.6110

Spreizweite / spread / écartement / abertura / apertura 105 mm
 Tiefe, Breite / Depth, Width / profondeur, largeur /
 profundidad, ancho / profondità, larghezza : 25 x 25 mm



BALFOUR-BABY
 17.6150 90 mm

Spreizweite / spread / écartement / abertura / apertura 90 mm

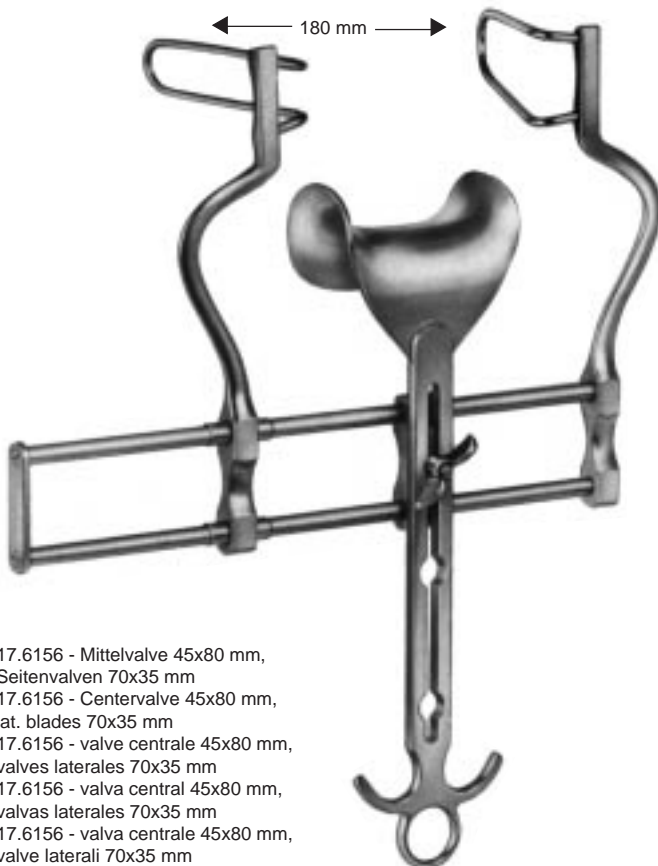

17.6156 - Mittelvalve 45x80 mm,
 Seitenvlaven 70x35 mm
 17.6156 - Centervlaven 45x80 mm,
 lat. blades 70x35 mm
 17.6156 - valve centrale 45x80 mm,
 valves laterales 70x35 mm
 17.6156 - valva central 45x80 mm,
 valvas laterales 70x35 mm
 17.6156 - valva centrale 45x80 mm,
 valve laterali 70x35 mm

BALFOUR
 17.6152 180 mm



17.6156 - Mittelvalve 45x80 mm,
 Seitenvlaven 70x35 mm
 17.6156 - Centervlaven 45x80 mm,
 lat. blades 70x35 mm
 17.6156 - valve centrale 45x80 mm,
 valves laterales 70x35 mm
 17.6156 - valva central 45x80 mm,
 valvas laterales 70x35 mm
 17.6156 - valva centrale 45x80 mm,
 valve laterali 70x35 mm

BALFOUR
 17.6153 180 mm

- 17.6158 - Mittelvalve 70x85, Seitenvalven 100x35 mm
- 17.6158 - Centervalue 70x85, lateral blades 100x35 mm
- 17.6158 - valve centrale 70x85, valves laterales 100x35 mm
- 17.6158 - valva central 70x85, valvas laterales 100x35 mm
- 17.6158 - valva centrale 70x85, valve laterali 100x35 mm

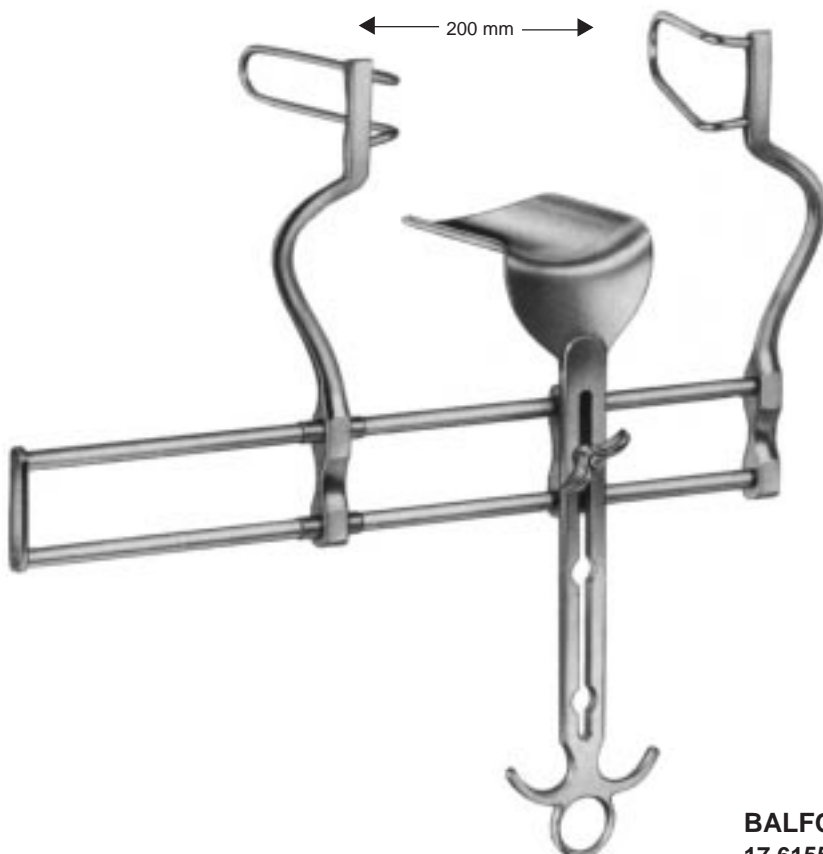
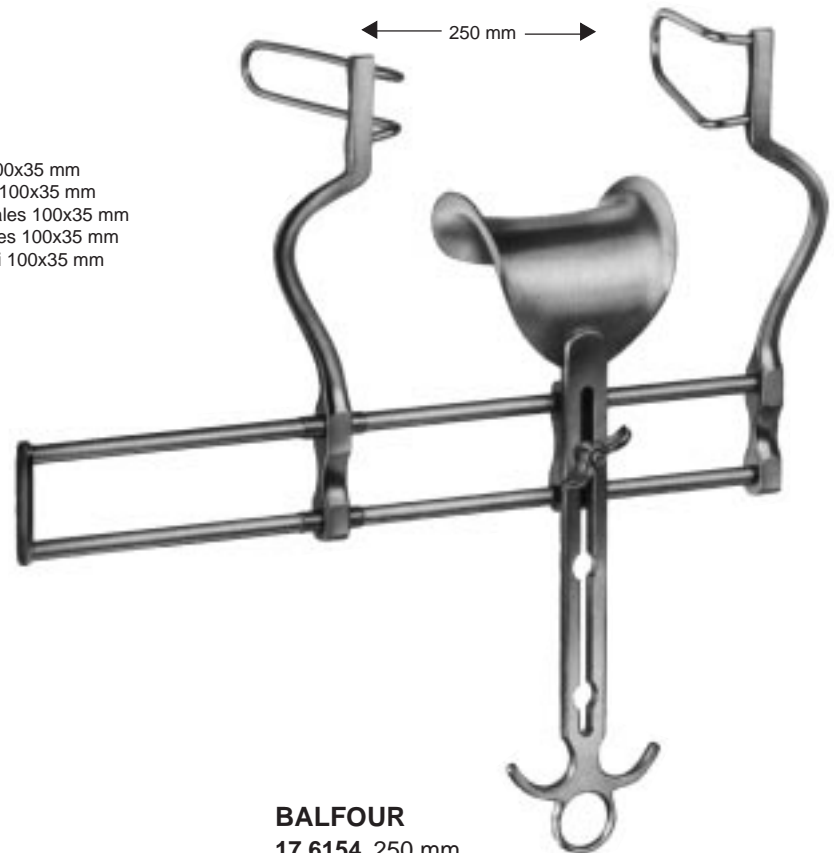

- 17.6157 - Mittelvalve 100x70mm,Seitenvalven 100x35 mm
- 17.6157 - Centervalue 100x70, lateral blades 100x35 mm
- 17.6157 - valve centrale 100x70, valves laterales 100x35 mm
- 17.6157 - valva central 100x70, valvas laterales 100x35 mm
- 17.6157 - valva centrale 100x70, valve laterali 100x35 mm

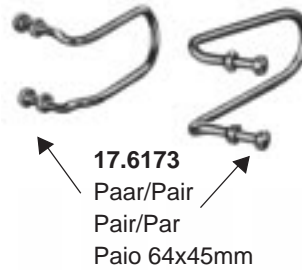

17.6178L
 Seitenarm links
 4th blade attachment left
 Bras latéral à gauche
 Brazo lateral izquierdo
 Braccio lateral sinistra

17.6178R
 Seitenarm rechts
 4th blade attachment right
 Bras latéral à droite
 Brazo lateral derecho
 Braccio lateral destra

BALFOUR-Modif.
 17.6170 200 mm
 17.6172 265 mm
 komplett/completo/
 complet/completo/completo

BALFOUR
 17.6178L
 17.6178R

Mittelvalven für Bauchdeckenhalter
 Center blades
 Valves centrales
 Valvas centrales
 Valve centrali



BALFOUR
 17.6156 45 x 80 mm
 17.6158 70 x 85 mm
 17.6159 80 x 90 mm

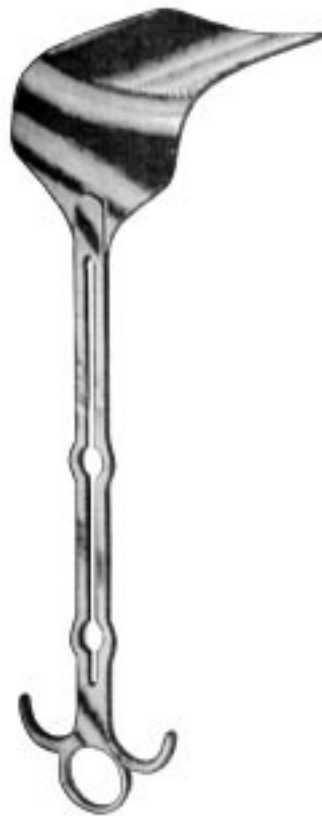

BALFOUR
 17.6157 100 x 70 mm



HORGAN
 17.6176 51 x 198 mm



HORGAN
 17.6177 51 x 127 mm

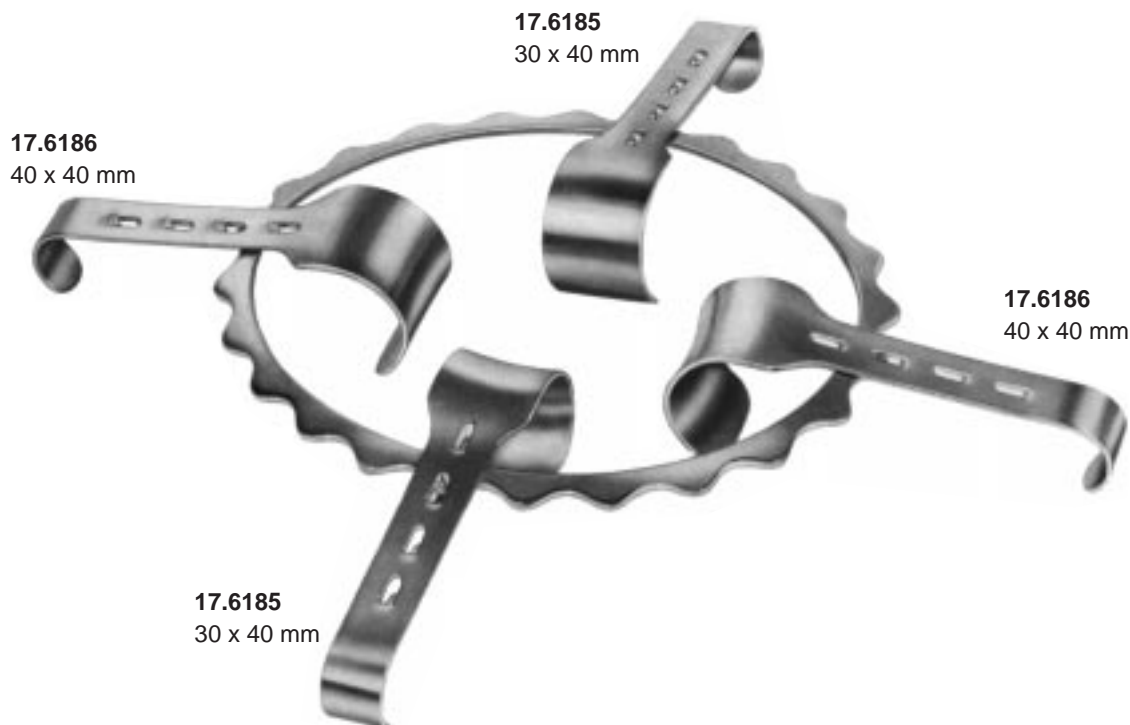

DENIS-BROWN

- 17.6180** für Kinder, bestehend aus:
 17.6181 Rahmen 180x150 mm
 17.6185 2 Valven 30x40 mm
 17.6186 2 Valven 40x40 mm
 for children, consisting of:
 17.6181 Frame 180x150 mm
 17.6185 2 valves 30x40 mm
 17.6186 2 valves 40x40 mm
 pour enfants, comprenant:
 17.6181 cadre 180x150 mm
 17.6185 2 valves 30x40 mm
 17.6186 2 valves 40x40 mm
 para niños, compuesto de:
 17.6181 cuadro 180x150 mm
 17.6185 2 valvas 30x40 mm
 17.6186 2 valvas 40x40 mm
 per bambini, composto da:
 17.6181 telaio 180x150 mm
 17.6185 2 valve 30x40 mm
 17.6186 2 valve 40x40 mm

DENIS-BROWN

- 17.6182** für Erwachsene, bestehend aus:
 17.6183 Rahmen 255x180 mm
 17.6185 2 Valven 30x40 mm
 17.6186 2 Valven 40x40 mm
 for adults, consisting of:
 17.6183 Frame 255x180 mm
 17.6185 2 valves 30x40 mm
 17.6186 2 valves 40x40 mm
 pour adultes, comprenant:
 17.6183 cadre 255x180 mm
 17.6185 2 valves 30x40 mm
 17.6186 2 valves 40x40 mm
 para adultos, compuesto de:
 17.6183 cuadro 255x180 mm
 17.6185 2 valvas 30x40 mm
 17.6186 2 valvas 40x40 mm
 per adulti, composto da:
 17.6183 telaio 255x180 mm
 17.6185 2 valve 30x40 mm
 17.6186 2 valve 40x40 mm

DENIS-BROWN

- 17.6181** Rahmen / frame / cadre / cuadro / telaio 180 x150 mm
17.6183 Rahmen / frame / cadre / cuadro / telaio 255 x180 mm

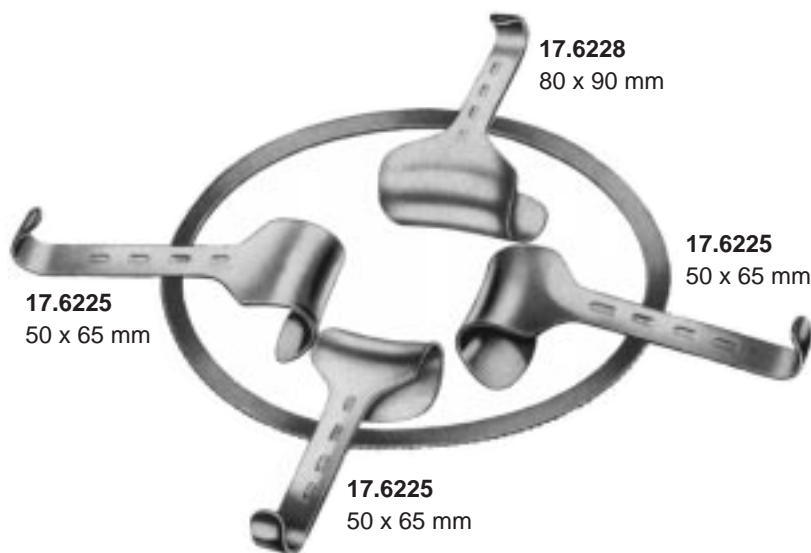

KIRSCHNER

17.6210

bestehend aus:

- 17.6211 ovaler Rahmen 300x240 mm
- 17.6225 3 Valven 50x65 mm
- 17.6228 1 Valve 80x90 mm
- 17.6229 1 Valve 98x50 mm
- 17.6230 1 Valve 105x35 mm

consisting of:

- 17.6211 oval Frame 300x240 mm
- 17.6225 3 valves 50x65 mm
- 17.6228 1 valve 80x90 mm
- 17.6229 1 valve 98x50 mm
- 17.6230 1 valve 105x35 mm

comprenant:

- 17.6211 cadre oval 300x240 mm
- 17.6225 3 Valves 50x65 mm
- 17.6228 1 Valve 80x90 mm
- 17.6229 1 Valve 98x50 mm
- 17.6230 1 Valve 105x35 mm

compuesto de:

- 17.6211 cuadro oval 300x240 mm
- 17.6225 3 valvas 50x65 mm
- 17.6228 1 valva 80x90 mm
- 17.6229 1 valva 98x50 mm
- 17.6230 1 valva 105x35 mm

composto da:

- 17.6211 telaio oval 300x240 mm
- 17.6225 3 valve 50x65 mm
- 17.6228 1 valva 80x90 mm
- 17.6229 1 valva 98x50 mm
- 17.6230 1 valva 105x35 mm

KIRSCHNER

17.6211 300x240 mm

Rahmen allein / Frame only / Cadre, seul / Cuadro, solo / Telaio, solo

KIRSCHNER

17.6220

bestehend aus:

- 17.6222 starrer Rahmen 250x250 mm
- 17.6224 2 Valven 42 x 55 mm
- 17.6225 2 Valven 50 x 65 mm

consisting of:

- 17.6222 rigid frame 250x250 mm
- 17.6224 2 valves 42 x 55 mm
- 17.6225 2 valves 50 x 65 mm

comprenant:

- 17.6222 cadre fixe 250 x 250 mm
- 17.6224 2 valves 42 x 55 mm
- 17.6225 2 valves 50 x 65 mm

compuesto de:

- 17.6222 cuadro fijo 250 x 250 mm
- 17.6224 2 valvas 42 x 55 mm
- 17.6225 2 valvas 50 x 65 mm

composto da:

- 17.6222 telaio fisso 250 x 250 mm
- 17.6224 2 valve 42 x 55 mm
- 17.6225 2 valce 50 x 65 mm

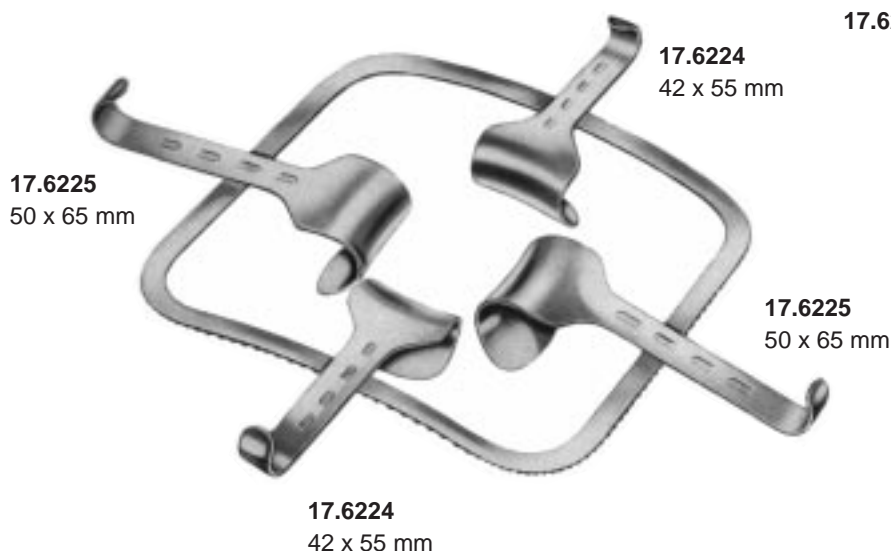

KIRSCHNER

17.6222 Rahmen allein / Frame only / Cadre, seul / Cuadro, solo / Telaio, solo



KIRSCHNER

- 17.6221** bestehend aus:
17.6219 faltbarer Rahmen 250x250 mm
17.6224 2 Valven 42 x 55 mm
17.6225 2 Valven 50 x 65 mm
consisting of:
17.6219 folding frame 250x250 mm
17.6224 2 valves 42 x 55 mm
17.6225 2 valves 50 x 65 mm
comprenant:
17.6219 cadre pliant 250 x 250 mm
17.6224 2 valves 42 x 55 mm
17.6225 2 valves 50 x 65 mm
compuesto de:
17.6219 cuadro plegable 250 x 250 mm
17.6224 2 valvas 42 x 55 mm
17.6225 2 valvas 50 x 65 mm
composto da:
17.6219 telaio pieghevole 250 x 250 mm
17.6224 2 valve 42 x 55 mm
17.6225 2 valce 50 x 65 mm

17.6219 250x250 mm
Rahmen allein / Frame only / Cadre, seul /
Cuadro, solo / Telaio, solo

KIRSCHNER

Haken / Blades / Lames / Valvas / Valve



17.6224
42 x 55 mm



17.6225
50 x 65 mm



17.6226
60 x 85 mm



17.6227
78 x 65 mm



17.6228
80 x 90 mm



17.6229
98 x 50 mm



17.6230
105 x 35 mm

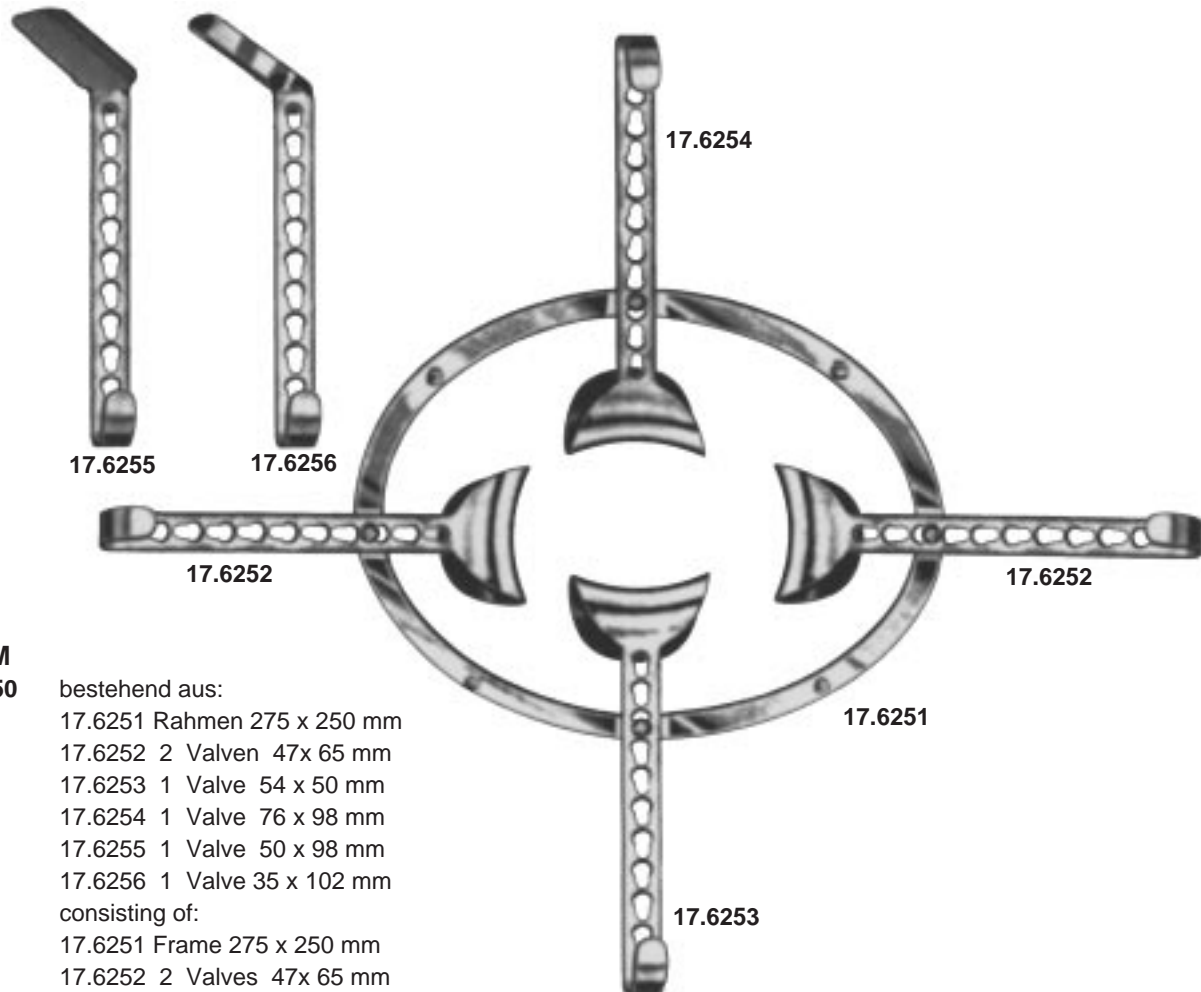

SEMM
17.6250

bestehend aus:

- 17.6251 Rahmen 275 x 250 mm
- 17.6252 2 Valven 47x 65 mm
- 17.6253 1 Valve 54 x 50 mm
- 17.6254 1 Valve 76 x 98 mm
- 17.6255 1 Valve 50 x 98 mm
- 17.6256 1 Valve 35 x 102 mm

consisting of:

- 17.6251 Frame 275 x 250 mm
- 17.6252 2 Valves 47x 65 mm
- 17.6253 1 Valve 54 x 50 mm
- 17.6254 1 Valve 76 x 98 mm
- 17.6255 1 Valve 50 x 98 mm
- 17.6256 1 Valve 35 x 102 mm

comprenant:

- 17.6251 Cadre 275 x 250 mm
- 17.6252 2 Valves 47x 65 mm
- 17.6253 1 Valve 54 x 50 mm
- 17.6254 1 Valve 76 x 98 mm
- 17.6255 1 Valve 50 x 98 mm
- 17.6256 1 Valve 35 x 102 mm

compuesto de:

- 17.6251 Cuadro 275 x 250 mm
- 17.6252 2 Valvas 47x 65 mm
- 17.6253 1 Valva 54 x 50 mm
- 17.6254 1 Valva 76 x 98 mm
- 17.6255 1 Valva 50 x 98 mm
- 17.6256 1 Valva 35 x 102 mm

composto da:

- 17.6251 Telaio 275 x 250 mm
- 17.6252 2 Valve 47x 65 mm
- 17.6253 1 Valva 54 x 50 mm
- 17.6254 1 Valva 76 x 98 mm
- 17.6255 1 Valva 50 x 98 mm
- 17.6256 1 Valva 35 x 102 mm

SEMM

17.6251 275 x 250 mm
 Rahmen allein / Frame only / Cadre, seul /
 Cuadro, solo / Telaio, solo

17.6252 47 x 65 mm

17.6253 54 x 50 mm

17.6254 76 x 98 mm

17.6255 50 x 98 mm

17.6256 35 x 135 mm

Valve / Blades / Lames / Valvas / Valve

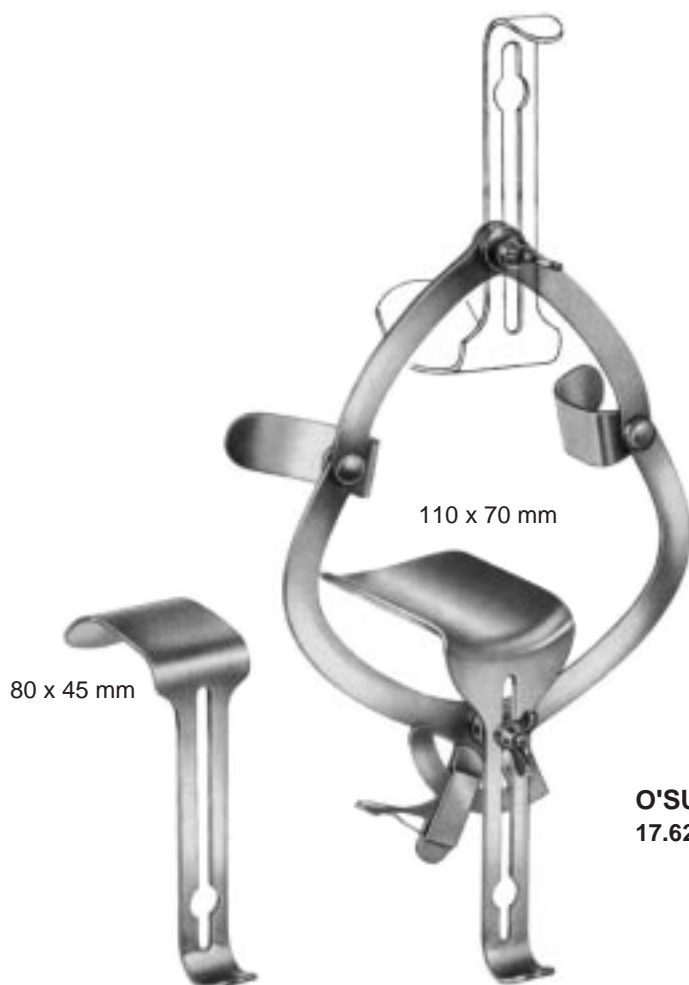

O'SULLIVAN-O'CONNOR

17.6260

bestehend aus:

17.6261 Rahmen mit 2 Seitenvalven 62 x 25 mm

17.6262 2 Valven 85 x 45 mm

17.6263 1 Valve 105 x 70 mm

consisting of:

17.6261 Frame with 2 lateral valves 62 x 25 mm

17.6262 2 Valves 85 x 45 mm

17.6263 1 Valve 105 x 70 mm

comprenant:

17.6261 Cadre avec 2 valves latérales 62 x 25 mm

17.6262 2 Valvex 85 x 45 mm

17.6263 1 Valve 105 x 70 mm

compuesto de:

17.6261 Cuadro con 2 valvas laterales 62 x 25 mm

17.6262 2 Valves 85 x 45 mm

17.6263 1 Valva 105 x 70 mm

composta da:

17.6261 Telaio con 2 valve laterali 62 x 25 mm

17.6262 2 Valve 85 x 45 mm

17.6263 1 Valva 105 x 70 mm

17.6261

Rahmen allein / Frame only / Cadre, seul /
Cuadro, solo / Telaio, solo

17.6262

45 x 85 mm

17.6263

70 x 105 mm

Valve / Blades / Lames / Valvas / Valve



ROCHARD
17.6277

Rahmen, doppelt
 Frame, double
 Cadre, double
 Quadro doble
 Telaio doppio

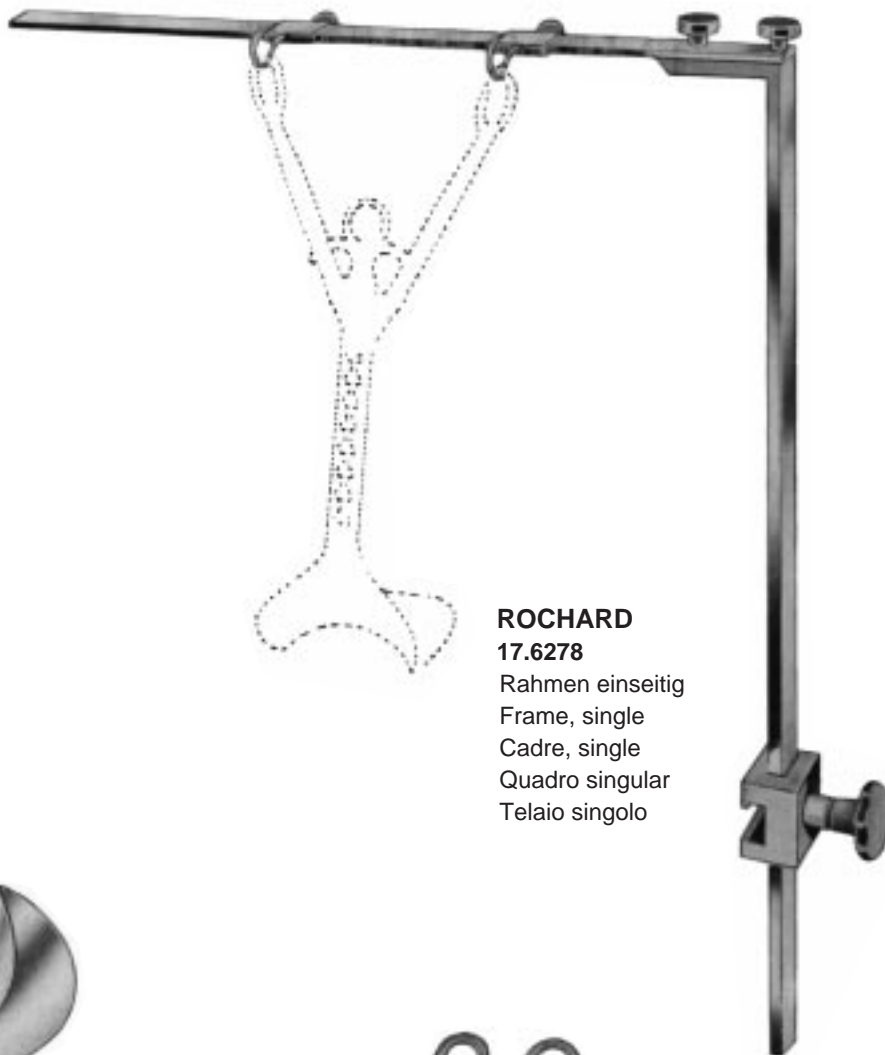

ROCHARD
17.6278

Rahmen einseitig
 Frame, single
 Cadre, single
 Quadro singular
 Telaio singolo



ROCHARD

17.6270 95 mm
17.6271 105 mm
17.6272 120 mm
17.6273 135 mm
17.6274 155 mm



ROCHARD
17.6279

Fixiervorrichtung
 Fixation device
 Compas articulé
 Dispositivo de fijación
 Dispositivo di fissaggio



DOYEN

17.6350 55 x 95 mm
17.6353 55 x 105 mm
17.6354 55 x 115 mm
17.6355 55 x 125 mm



ABDOMINAL

46.0169 20,5 cm
Spekulum 70 mm / 90°
Abdominal Specula 70 mm / 90°
Spéculum abdominal 70 mm / 90°
espéculo abdominale 70 mm / 90°
Specola abdominale 70 mm / 90°



17.6309 8 mm ø
20 Ersatzknöpfe
20 Spare buttons
20 Boutons de rechange
20 Botónes de repuesto
20 Bottone de ricambio

FOERSTER

17.6300 Ø 255 mm

Kunststoff, schwarz, röntgenfähig, komplett mit 4 Valven Nr. 17.6303
plastic, black, transparent to X-Ray, complete with 4 valves 17.6303
plastique, noir, transparent aux rayons X, complet avec 4 valves 17.6303
plástico, negro, transparente a los rayos-X, completo con 4 valvas 17.6303
plastica, nero, radiotrasparente, completo con 4 valve 17.6303

17.6301

Rahmen / frame / Cadre / Cuadro / Telaio Ø 255 mm



17.6303 50 x 65 mm



17.6304 65 x 75 mm

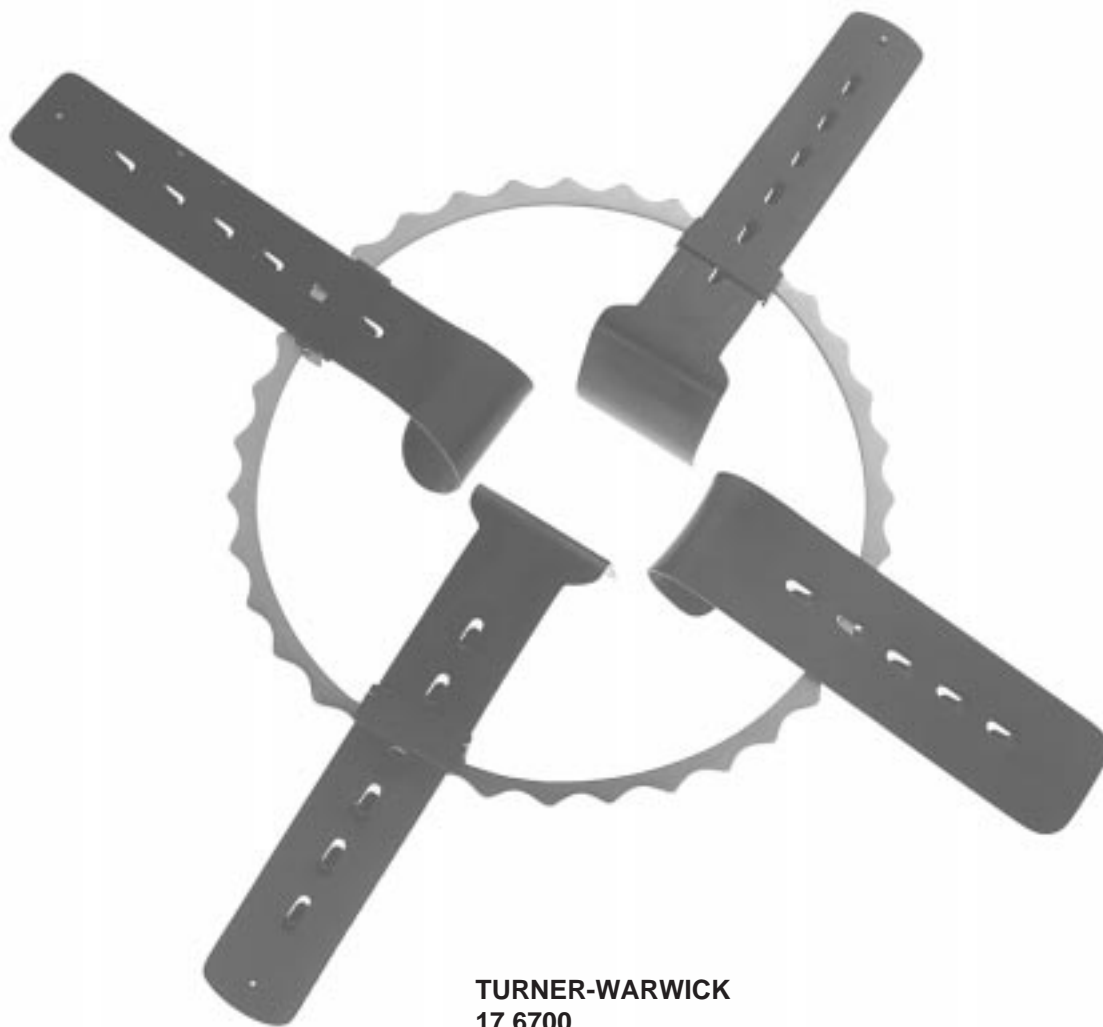

**TURNER-WARWICK
17.6700**

bestehend aus

consisting of:

comprendant:

compuesto de:

composta da:

17.6701 1

17.6702 1

17.6703 1

17.6710 2

17.6711 2

17.6712 2

17.6713 2

17.6714 2

17.6715 2

17.6716 2

17.6717 2

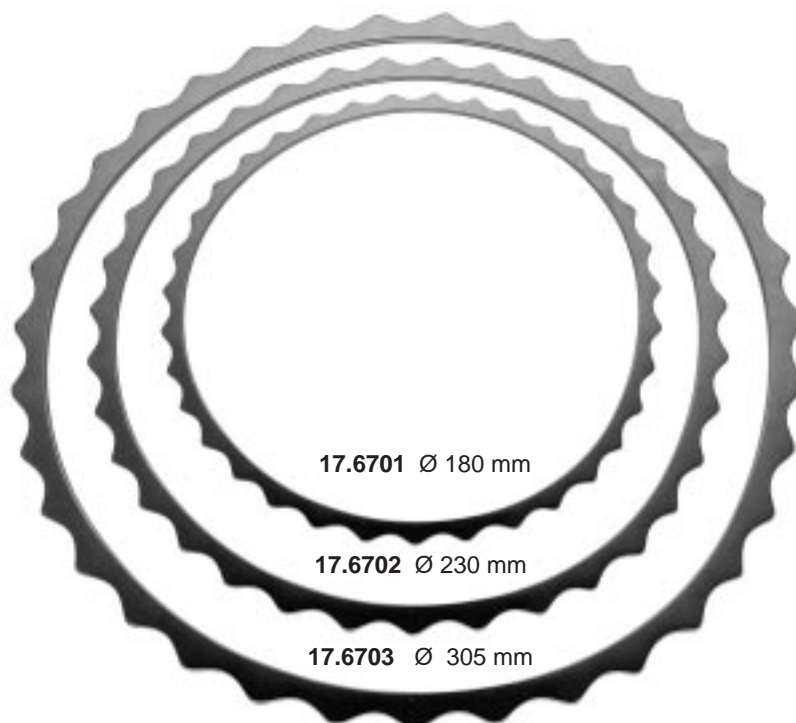

17.6701 Ø 180 mm

17.6702 Ø 230 mm

17.6703 Ø 305 mm

TURNER-WARWICK

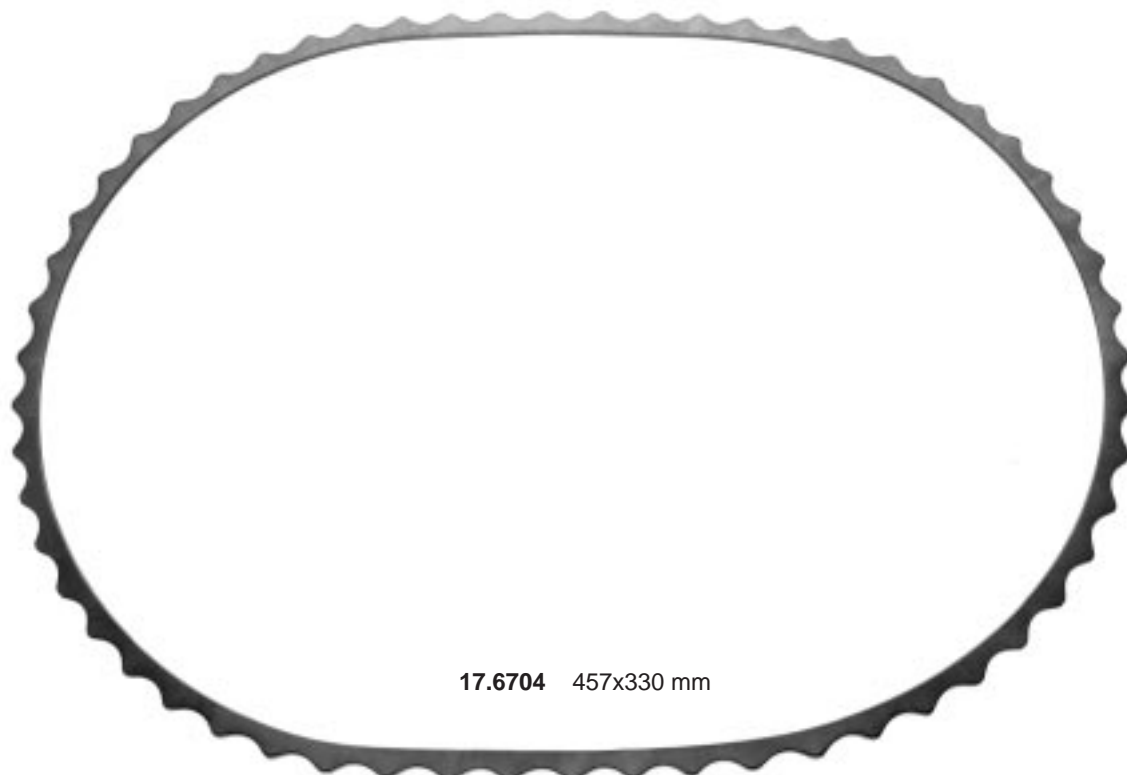

17.6704 457x330 mm

TURNER-WARWICK



TURNER-WARWICK
17.6710 76 x 19 mm

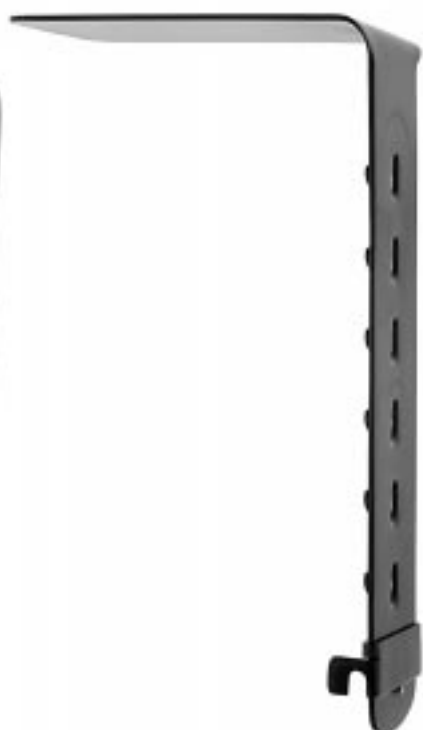

TURNER-WARWICK
17.6711 102 x 38 mm



TURNER-WARWICK
17.6712 89 x 57 mm



TURNER-WARWICK
17.6713 114 x 57 mm



TURNER-WARWICK
17.6714 51 x 38 mm

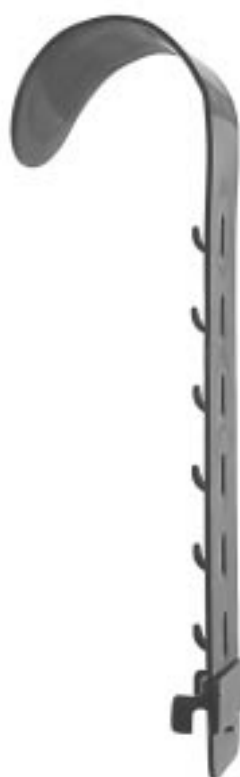

TURNER-WARWICK
17.6715 76 x 60 mm

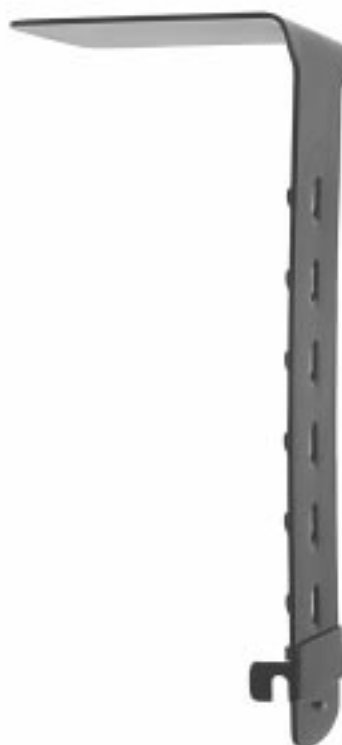

TURNER-WARWICK
17.6716 89 x 60 mm
17.6717 114 x 60 mm



TURNER-WARWICK
17.6718 13 mm

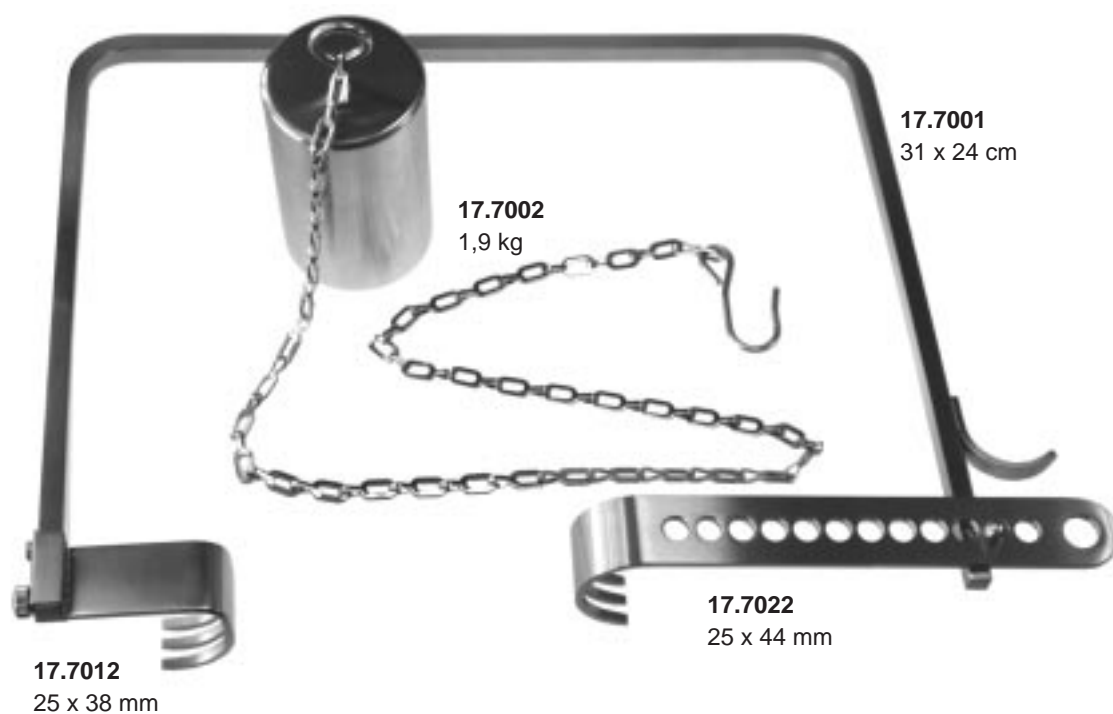

CHARNLEY compl.
17.7000

bestehend aus:

consisting of:

comprendant:

compuesto de:

composta da:

17.7001 Rahmen / Frame / Cadre / Cuadro / Telaio 31 x 24 cm

17.7002 Gewicht mit Kette / Weight with chain / poids avec chaîne /
peso con cadena / peso con catena

17.7012 Valve /Valve / Valva / Valve 25 x 38 mm

17.7022 Valve /Valve / Valva / Valve 25 x 44 mm



CLOWARD

17.8000 17 cm
 mit je 2 Valven 17.8002 - 17.8006
 with 2 ea. Valves 17.8002 - 17.8006
 avec 2 paires de valves 17.8002 - 17.8006
 con 2 valvas de c.u. Ref. 17.8002 - 17.8006
 con 2 valve ad innesto 17.8002 - 17.8006

17.8001 17 cm
 Sperrer allein
 Spreader only
 Ecarteur seul
 Separador suelto
 Divaricatore solo

stumpf
 blunt
 mousse
 romo
 smusso



CLOWARD
17.8002 40 mm



17.8003 45 mm



17.8004 50 mm



17.8005 55 mm



17.8006 60 mm

17.8007
 Satz mit 5 Valven 17.8002 - 17.8006
 Set of 5 Blades 17.8002 - 17.8006
 Jeu de 5 valves 17.8002 - 17.8006
 Juego de 5 valvas 17.8002 - 17.8006
 Serie di 5 valve 17.8002 - 17.8006



CLOWARD

17.8010 25 cm
 mit je 2 Valven 17.8012 - 17.8016
 with 2 ea. Valves 17.8012 - 17.8016
 avec 2 paires de valves 17.8012 - 17.8016
 con 2 valvas de c.u. Ref. 17.8012 - 17.8016
 con 2 valve ad innesto 17.8012 - 17.8016

17.8011 25 cm
 Sperrer allein
 Spreader only
 Ecarteur seul
 Separador suelto
 Divaricatore solo

gezahnt
 serrated
 dentelé
 dentada
 dentate



17.8012 40 mm

17.8013 45 mm

17.8014 50 mm

17.8015 55 mm

17.8016 60 mm

17.8017
 Satz mit 5 Valven 17.8012 - 17.8016
 Set of 5 Blades 17.8012 - 17.8016
 Jeu de 5 valves 17.8012 - 17.8016
 Juego de 5 valvas 17.8012 - 17.8016
 Serie di 5 valve 17.8012 - 17.8016



17.8042 45 x 35 mm
17.8043 45 x 45 mm
 spitz
 sharp
 pointu
 agudo
 acuto



17.8044 25 x 35 mm
17.8045 25 x 45 mm
 stumpf
 blunt
 mousse
 romo
 smusso

HOEN

17.8040 27 cm
 mit 4 Valven 17.8042 - 17.8045
 with 4 blades 17.8042 - 17.8045
 avec 4 valves 17.8042 - 17.8045
 con 4 valvas 17.8042 - 17.8045
 con 4 valve 17.8042 - 17.8045

17.8041 27 cm
 Sperrer allein / Spreader only
 Ecarteur seul
 Separador suelto / Divaricatore solo



17.8052
 50 mm



17.8053
 64 mm

CLOWARD-HOEN

17.8050 25 cm
 mit je 2 Valven 17.8052, 17.8053
 with 2 ea. Valves 17.8052, 17.8053
 avec 2 paires de valves 17.8052, 17.8053
 con 2 valvas de c.u. Ref. 17.8052, 17.8053
 con 2 valve ad innesto 17.8052, 17.8053

17.8051 25 cm
 Sperrer allein / Spreader only / Ecarteur seul
 Separador suelto / Divaricatore solo



MISKIMON
17.8060 21cm
32 x 35 mm

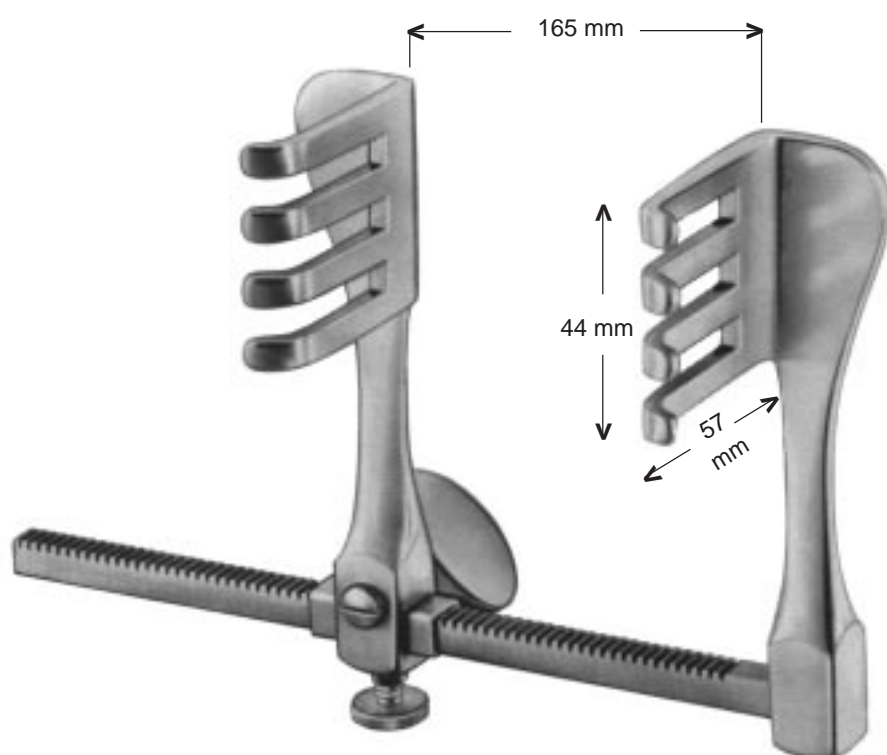

BADGLEY
17.8100



SCOVILLE-RICHTER

17.8130

bestehend aus:

- 17.8131 Rahmen, Spreizweite 14 cm
- 17.8132 Seitenvalve 3-zahnig 35 x 60 mm
- 17.8133 Seitenvalve 4-zahnig 50 x 60 mm

consisting of:

- 17.8131 Frame, spreading 14 cm
- 17.8132 Blade 3-prong, 35 x 60 mm
- 17.8133 Blade 4-prong, 50 x 60 mm

comprenant:

- 17.8131 Cadre, écartement 14 cm
- 17.8132 Valve à 3 dents 35 x 60 mm
- 17.8133 Valve à 4 dents 50 x 60 mm

compuesto de:

- 17.8131 Bastidor, extensión 14 cm
- 17.8132 Valva con 3 dientes 35 x 60 mm
- 17.8133 Valva con 4 dientes 50 x 60 mm

composto di:

- 17.8131 Telaio, apertura 14 cm
- 17.8132 valva con 3 denti, 35 x 60 mm
- 17.8133 valva con 4 denti, 50 x 60 mm

17.8131

Sperrer allein / Spreader only / Ecarteur seul / Separador
suelto / Divaricatore solo



SCOVILLE-RICHTER

17.8132 35x60 mm



17.8133 50x60 mm



17.8134 40x28 mm



17.8135 50x50 mm



17.8136 62x38 mm

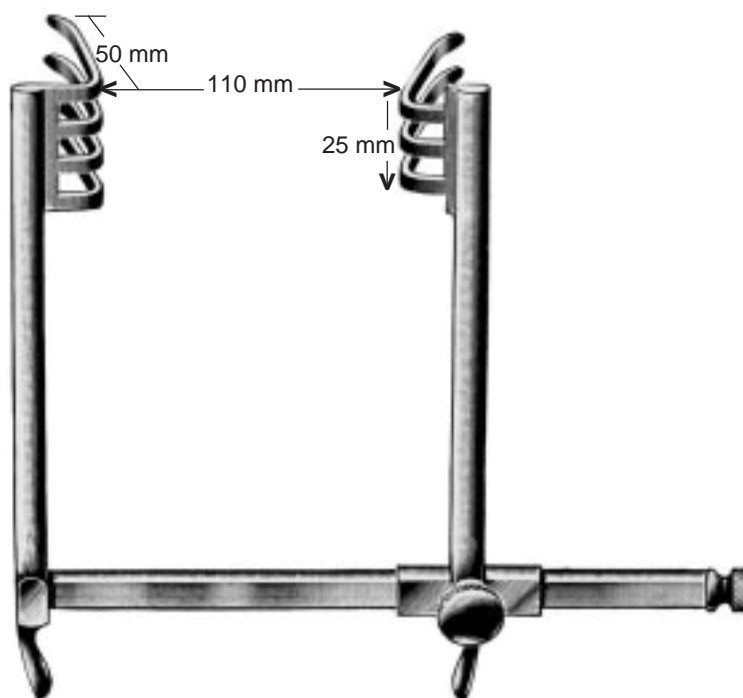

TEMPLE-FAY
17.8155



SCOVILLE

17.8161

bestehend aus:

17.8160 Rahmen, Spreizweite 15 cm

17.8172 Haken, stumpf 50 mm

17.8174 Valve gezahnt 64 x 24 mm

consisting of:

17.8160 Frame, spreading 15 cm

17.8172 blunt hook, 50 mm

17.8174 toothed blade 64 x 25 mm

comprenant:

17.8160 Cadre, écartement 15 cm

17.8172 Crochet mousse, 50 mm

17.8174 Valve dentelé 64 x 25 mm

compuesto de:

17.8160 Bastidor, extensión 15 cm

17.8172 Gancho romo, 50 mm

17.8174 Valva dentado 64 x 25 mm

composto di:

17.8160 Telaio, apertura 15 cm

17.8172 Uncino smusso 50 mm

17.8174 Valva dentato 64 x 25 mm

17.8160

Sperrer allein / Spreader only / Ecarteur seul /
Separador suelto / Divaricatore solo



SCOVILLE-HAVERFIELD

17.8164

bestehend aus:

- 17.8165 Rahmen mit Gelenk, Spreizweite 15 cm
- 17.8170 Haken, spitz 50 mm
- 17.8174 Valve gezahnt 64 x 24 mm

consisting of:

- 17.8165 Frame with joint, spreading 15 cm
- 17.8170 sharp hook, 50 mm
- 17.8174 toothed blade 64 x 25 mm

comprenant:

- 17.8165 Cadre avec articulation, écartement 15 cm
- 17.8170 Crochet pointu, 50 mm
- 17.8174 Valve dentelé 64 x 25 mm

compuesto de:

- 17.8165 Bastidor con articulación, extensión 15 cm
- 17.8170 Gancho agudo, 50 mm
- 17.8174 Valva dentado 64 x 25 mm

composto di:

- 17.8165 Telaio con articolazione, apertura 15 cm
- 17.8170 Uncino acuto 50 mm
- 17.8174 Valva dentato 64 x 25 mm

17.8165

Rahmen mit Gelenk Spreizweite 15 cm

Frame with joint, spreading 15 cm

Cadre avec articulation, écartement 15 cm

Bastidor con articulación, extension 15 cm

Telaio con articolazione, apertura 15 cm



SCOVILLE

17.8170 50 mm

17.8171 75 mm

spitz
sharp
pointu
agudo
acuto



SCOVILLE

17.8172 50 mm

17.8173 75 mm

stumpf
blunt
mousse
romo
smusso



SCOVILLE

17.8174 64 x 25 mm

17.8175 64 x 50 mm

17.8177 88 x 25 mm



SCOVILLE

17.8178 41 x 38 mm

17.8179 67 x 44 mm



TAYLOR

17.8181 48 x 51 mm

17.8182 64 x 50 mm

17.8183 80 x 57 mm

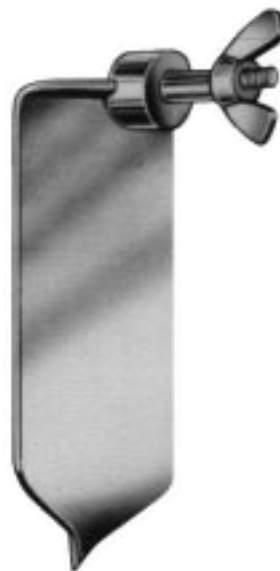

TAYLOR

17.8185 75 x 32 mm

17.8186 100 x 42 mm



HIBBS

17.8187 50 x 19 mm

17.8188 50 x 25 mm

17.8189 50 x 50 mm

17.8190 64 x 25 mm

17.8191 64 x 38 mm

17.8192 75 x 25 mm

17.8193 75 x 38 mm

17.8194 75 x 50 mm

17.8195 100 x 25 mm

17.8196 100 x 50 mm



MEYERDING

17.8201 50 x 25 mm

17.8203 75 x 25 mm

17.8205 90 x 50 mm

17.6542	MODULAR RETRAKTOR KIT II	
	bestehend aus:	Anzahl
17.6552	horizontale Stange	1
17.6554	Pfosten-Kupplung	1
17.6557	ovaler Rahmen 368 x 267 mm	1
17.6561	Spatel 51 x 152 mm biegsam	2
17.6562	Spatel 38 x 152 mm biegsam	1
17.6566	HARRINGTON Haken	1
17.6567	Spatel 72 x 152 mm biegsam	1
17.6568	KELLY Haken 51 x 76 mm	2
17.6569	KELLY Haken 51 x 102 mm	1
17.6570	KELLY Haken 51 x 127 mm	1
17.6571	KELLY Haken 51 x 152 mm	1
17.6576	BALFOUR Haken 67 x 76 mm	1
17.6577	GELPI Haken	1
17.6579	Standard Rasten	2
17.6580	Rasten schräg	6
17.6581	Tischpfosten	1
17.6582	Stange flexibel horizontal	1
17.6583	Rahmen geteilt 266 x 495 mm	1

17.6546	MODULAR REKTAL KIT	
	bestehend aus:	Anzahl
17.6584	runder Rahmen 216 mm	1
17.6585	Rektalvalve 73 mm lang	2
17.6586	Rektalvalve 98 mm lang	2

17.6547	MODULAR VAGINAL KIT	
	bestehend aus:	Anzahl
17.6554	PfostenKupplung	1
17.6580	Rasten schräg	4
17.6581	Tischpfosten	1
17.6582	Stange flexibel horizontal	1
17.6590	Vaginal Rahmen 203 x 266 mm	1
17.6591	MAGRINA Vaginal Haken 25 x 76 mm	1
17.6592	DEAVER Haken 25 x 89 mm	1
17.6593	DEAVER Haken 25 x 127 mm	1
17.6594	Vaginalhaken 25 x 114 mm	1

17.6578	MODULAR KIT FÜR KLEINE ERÖFFNUNGEN	
	bestehend aus:	Anzahl
17.6563	KELLY Spatel 51 x 51mm	1
17.6574	KELLY Haken 25 x 38 mm	1
17.6575	KELLY Haken 25 x 63 mm	1
17.6577	GELPI Haken	1
17.6584	runder Rahmen 216 mm	1

Sonderzubehör:

17.6553	Verlängerungsteil 305 mm
17.6556	ovaler Rahmen 267x470 mm
17.6558	ovaler Rahmen 203 x 311 mm
17.6559	runder Rahmen 266 mm
17.6560	runder Rahmen 317 mm
17.6565	KELLY Spatel 51 x 38 mm
17.6572	KELLY Haken 51 x 64mm
17.6587	Rahmen geteilt 216 x 356 mm
17.6588	Rahmen geteilt 317 x 495 mm
17.6635	Ring Segmente 216 mm (Paar)
17.6639	SCOVILLE Haken 50 mm
17.6640	SCOVILLE Haken 83 mm
17.6641	MEYERDING Haken 60x17 mm
17.6642	MEYERDING Haken 85x25 mm
17.6643	MEYERDING Haken 95x50 mm
17.6644	Haken 3-zahnig 19x17 mm
17.6645	Haken 4-zahnig 8x19 mm
17.6646	Haken 6-zahnig 8x25 mm

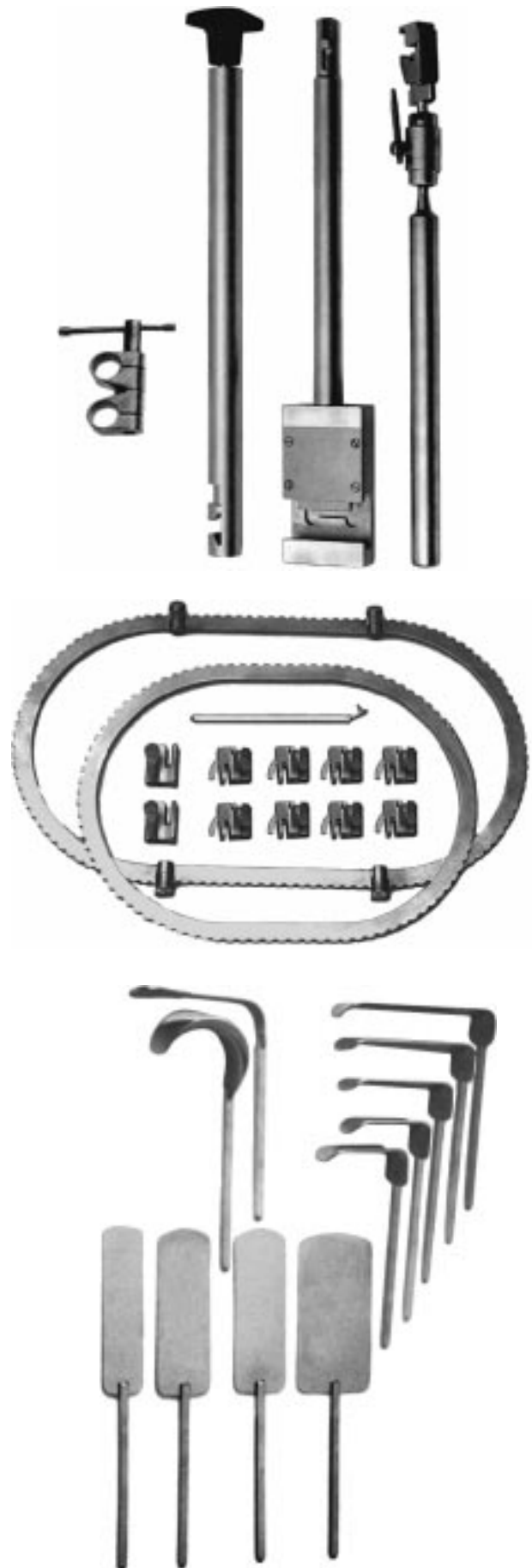

17.6542	MODULAR RETRACTOR KIT II	
	consisting of	Quantity
17.6552	Horizontal Bar	1
17.6554	Post Coupling	1
17.6557	Medium Oval Ring	1
17.6561	Spatulas mall. 152 x 51 mm	2
17.6562	"Spatula 6" x 1 1/2" malleable"	1
17.6566	HARRINGTON Retractor	1
17.6567	Spatula 72 x 152 mm malleable	1
17.6568	KELLY Retractor 51 x 76 mm	2
17.6569	KELLY Retractor 51 x 102 mm	1
17.6570	KELLY Retractor 51 x 127 mm	1
17.6571	KELLY Retractor 51 x 152 mm	1
17.6576	BALFOUR Blade 67 x 76 mm	1
17.6577	GELPI Point Blade	1
17.6579	Standard Ratchets	2
17.6580	Tilt Ratchets	6
17.6581	Table Post	1
17.6582	flexible Bar horizontal	1
17.6583	Segmented Ring 10 1/2 x 19 1/2"	1

17.6546	MODULAR RECTAL KIT	
	consisting of	Quantity
17.6584	Medium Round Ring 8 1/2" i.d"	1
17.6585	Rectal Blade 7/8" x 2 7/8"	2
17.6586	Rectal Blade 7/8" x 3 7/8"	2

17.6547	MODULAR VAGINAL KIT	
	consisting of	Quantity
17.6554	Post Coupling	1
17.6580	Tilt Ratchets	4
17.6581	Table Post	1
17.6582	flexible Bar horizontal	1
17.6590	Vaginal Retractor Ring 8 x 10 1/2"	1
17.6591	MAGRINA Vag. Retractor lateral blade	1
17.6592	DEAVER Blade 1" x 3 1/2"	1
17.6593	DEAVER Blade 1" x 5"	1
17.6594	DEAVER Blade 1" x 4 1/2"	1

17.6578	MODULAR SMALL INCISION KIT	
	consisting of	Quantity
17.6563	KELLY Spatula 2" x 2"	1
17.6574	KELLY Retractor 25 x 38 mm	1
17.6575	KELLY Retractor 25 x 63 mm	1
17.6577	GELPI Point Blade	1
17.6584	Medium Round Ring 8 1/2" i.d"	1

Optional accessories:	
17.6553	Vertical Extension Bar 12"
17.6556	Large Oval Ring 12" x 18 1/2"
17.6558	Small Oval Ring 8" x 12 1/4"
17.6559	Medium Round Ring 10 1/2" i."
17.6560	Large Round Ring 12 1/2" i."
17.6565	KELLY Spatula 2" x 1 1/2"
17.6572	KELLY Retractor 51 x 64mm
17.6587	Segmented Ring 8 1/2 x 14"
17.6588	Segmented Ring 12 1/2 x 19 1/2"
17.6635	Ring Segments 8 1/2" (pair)"
17.6639	SCOVILLE Hook 2"
17.6640	SCOVILLE Hook 3 1/4"
17.6641	MEYERDING Hook 2 1/3" x 1/3"
17.6642	MEYERDING Hook 3 1/3" x 1"
17.6643	MEYERDING Hook 3 3/4" x 2"
17.6644	Hook 3 pr. 3/4" x 2/3"
17.6645	Hook 4 pr. 1/3" x 3/4"
17.6646	Hook 6 pr. 1/3" x 1"

17.6542	MODULAR ECARTEUR KIT II	
	comprenant:	quantité
17.6552	Pied horizontal	1
17.6554	Connecteur p. rallongement	1
17.6557	Cadre medium	1
17.6561	Spatules mall 152x51 mm	2
17.6562	Spatule 38 x 152 mm malleable	1
17.6566	HARRINGTON Ecarteur	1
17.6567	Spatule 72 x 152 mm malleable	1
17.6568	KELLY Ecartuer 51 x 76 mm	2
17.6569	KELLY Ecartuer 51 x 102 mm	1
17.6570	KELLY Ecarteur 51 x 127 mm	1
17.6571	KELLY Ecarteur 51 x 152 mm	1
17.6576	BALFOUR Ecartuer 67 x 76 mm	1
17.6577	GELPI Ecarteur	1
17.6579	Crémaillère standard	2
17.6580	Crémaillère oblique	6
17.6581	Pied de Table	1
17.6582	Bras flexible horizontal	1
17.6583	Cadre segmentaire 266 x 495	1

17.6546	MODULAR RECTAL KIT	
	comprenant:	quantité
17.6584	Cadre ronde 216 mm	1
17.6585	Valve rectale 73 mm	2
17.6586	Valve rectale 98 mm	2

17.6547	MODULAR VAGINAL KIT	
	comprenant:	quantité
17.6554	Connecteur p.rallongement	1
17.6580	Crémaillère oblique	4
17.6581	Pied de Table	1
17.6582	Bras flexible horizontal	1
17.6590	Cadre vaginal 203 x 266 mm	1
17.6591	MAGRINA Ecarteur vaginal latéral 25 x 76 mm	1
17.6592	DEAVER Valve 25 x 89 mm	1
17.6593	DEAVER Valve 25 x 127 mm	1
17.6594	Valve vginale 25 x 114 mm	1

17.6578	MODULAR BOITE POUR PETITES INCISIONS	
	comprenant:	quantité
17.6563	KELLY Spatule 51 x 51 mm	1
17.6574	KELLY Ecarteur 25 x 38 mm	1
17.6575	KELLY Ecarteur 25 x 63 mm	1
17.6577	GELPI Ecarteur	1
17.6584	Cadre ronde 216 mm	1

Accessoires optionels:	
17.6553	Pièce/ rallongement 305 mm
17.6556	cadre oval 267 x 470 mm
17.6558	Cadre 203 x 311 mm
17.6559	Cadre ronde 266 mm
17.6560	Cadre ronde 317 mm
17.6565	KELLY Spatule 51 x 38 mm
17.6572	KELLY Ecarteur 51 x 64 mm
17.6587	Cadre segmentaire 216 x 356
17.6588	Cadre segmentaire 317 x 495
17.6635	Segment semi-circulaire Paire 216 mm
17.6639	SCOVILLE Crochet 50 mm
17.6640	SCOVILLE Crochet 83 mm
17.6641	MEYERDING Crochet 60x17 mm
17.6642	MEYERDING Crochet 85x25 mm
17.6643	MEYERDING Crochet 95x50 mm
17.6644	Crochet 3 dents 19x17 mm
17.6645	Crochet 4 dents 8x19 mm
17.6646	Crochet 6 dents 8x25 mm

17.6542	MODULAR SEPARADOR KIT II		
compuesto de:		cantidad	
17.6552	Poste horizontal	1	
17.6554	Connector p. empalme	1	
17.6557	Quadro medial	1	
17.6561	Espatulas mall.152x51 mm	2	
17.6562	Espatula 38 x 152 mm malleabl	1	
17.6566	HARRINGTON Separador	1	
17.6567	Espatula 72x152 mm malleable	1	
17.6568	KELLY Separador 51 x 76 mm	2	
17.6569	KELLY Separador 51 x 102 mm	1	
17.6570	KELLY Separador 51 x 127 mm	1	
17.6571	KELLY Separador 51 x 152 mm	1	
17.6576	BALFOUR Separador 67 x 76 mm	1	
17.6577	GELPI Separador	1	
17.6579	Cremallera standard	2	
17.6580	Cremallera obliquo	6	
17.6581	Poste vertical	1	
17.6582	Brazo flex. horizontal	1	
17.6583	Cuadro en segmentos 266 x 495 mm	1	

17.6546	MODULAR RECTAL KIT		
compuesto de:		cantidad	
17.6584	Quadro rondo 216 mm	1	
17.6585	Valva rectal 73 mm	2	
17.6586	Valva rectal 98 mm	2	

17.6547	MODULAR VAGINAL KIT		
compuesto de:		cantidad	
17.6554	Connector p. empalme	1	
17.6580	Cremallera obliquo	4	
17.6581	Poste vertical	1	
17.6582	Brazo flex. horizontal	1	
17.6590	Cuadro vaginal 203 x 266 mm	1	
17.6591	MAGRINA Separador vaginal lateral 25x76mm	1	
17.6592	DEAVER Valva 25 x 89 mm	1	
17.6593	DEAVER Valva 25 x 127 mm	1	
17.6594	Valva vaginal 25 x 114 mm	1	

17.6578	MODULAR KIT PARA INCISIONES PEQUENAS		
compuesto de:		cantidad	
17.6563	KELLY Espatula 51 x 51 mm	1	
17.6574	KELLY Separador 25 x 38 mm	1	
17.6575	KELLY Separador 25 x 63 mm	1	
17.6577	GELPI Separador	1	
17.6584	Quadro rondo 216 mm	1	

Accesorios opcionales:

17.6553	Pieza de empalme 305 mm		
17.6556	Cuadro oval 267 x 470 mm		
17.6558	Cuadro 203 x 311 mm		
17.6559	Quadro rondo 266 mm		
17.6560	Quadro rondo 317 mm		
17.6565	KELLY Espatula 51 x 38 mm		
17.6572	KELLY Separador 51 x 64 mm		
17.6587	Cuadro en segmentos 216 x 356 mm		
17.6588	Cuadro en segmentos 317 x 495 mm		
17.6635	Segmento semi-circular (par) 216 mm		
17.6639	SCOVILLE Gancho 50 mm		
17.6640	SCOVILLE Gancho 83 mm		
17.6641	MEYERDING Gancho 60x17 mm		
17.6642	MEYERDING Gancho 85x25 mm		
17.6643	MEYERDING Gancho 95x50 mm		
17.6644	Gancho 3 dientes 19x17 mm		
17.6645	Gancho 4 dientes 8x19 mm		
17.6646	Gancho 6 dientes 8x25 mm		

17.6542	MODULAR DIVARICATORE KIT II		
composta da:		quantita	
17.6552	Gambo orizzontale	1	
17.6554	Agganciamento di montante	1	
17.6557	Telaio ovale 368x267 mm	1	
17.6561	Spatola flessibile 152 x 51 mm	2	
17.6562	Spatola flessibile 389 x 152 mm	1	
17.6566	HARRINGTON Gancio	1	
17.6567	Spatola flessibile 72x152 mm	1	
17.6568	KELLY Gancio 51 x 76 mm	2	
17.6569	KELLY Gancio 51 x 102 mm	1	
17.6570	KELLY Gancio 51 x 127 mm	1	
17.6571	KELLY Gancio 51 x 152 mm	1	
17.6576	BALFOUR Gancio 67 x 76 mm	1	
17.6577	GELPI Gancio	1	
17.6579	Cremagliera standard	2	
17.6580	Cremagliera obliqua	6	
17.6581	Montante di tavola	1	
17.6582	Montane orizzontale flessibile	1	
17.6583	Telaio en segmentos 266 x 495 mm	1	

17.6546	MODULAR RECTAL KIT		
composta da:		quantita	
17.6584	Telaio mediano tondo 216 mm	1	
17.6585	Valva rettale 73 mm	2	
17.6586	Valva rettale 98 mm	2	

17.6547	MODULAR VAGINAL KIT		
composta da:		quantita	
17.6554	Agganciamento di montante	1	
17.6580	Cremagliera obliqua	4	
17.6581	Montante di tavola	1	
17.6582	Montane orizzontale flessibile	1	
17.6590	Telaio vaginal 203 x 266 mm	1	
17.6591	MAGRINA Gancio vaginal lateral 25x76mm	1	
17.6592	DEAVER Valva 25x89 mm	1	
17.6593	DEAVER Valva 25x127 mm	1	
17.6594	DEAVER Valva 25x114 mm	1	

17.6578	MODULAR KIT PER PICCOLE INCISIONE		
composta da:		quantita	
17.6563	KELLY Spatola 51 x 51 mm	1	
17.6574	KELLY Gancio 25 x 38 mm	1	
17.6575	KELLY Gancio 25 x 63 mm	1	
17.6577	GELPI Gancio	1	
17.6584	Telaio mediano tondo 216 mm	1	

Accessori opzionali:

17.6553	Gambo / prolunga verticale 305mm		
17.6556	Telaio ovale 267x470 mm		
17.6558	Telaio ovale 203x311 mm		
17.6559	Telaio tondo 266 mm		
17.6560	Telaio tondo 317 mm		
17.6565	KELLY Spatola 51 x 38 mm		
17.6572	KELLY Gancio 51 x 64 mm		
17.6587	Telaio en segmenti 216 x 356 mm		
17.6588	Telaio en segmenti 317 x 495 mm		
17.6635	Segmenti semi-circular 216 mm (paio)		
17.6639	SCOVILLE Gancio 50 mm		
17.6640	SCOVILLE Gancio 83 mm		
17.6641	MEYERDING Gancio 60 x 17 mm		
17.6642	MEYERDING Gancio 85 x 25 mm		
17.6643	MEYERDING Gancio 95 x 50 mm		
17.6644	Gancio 3 denti 19 x 17 mm		
17.6645	Gancio 4 denti 8 x 19 mm		
17.6646	Gancio 6 denti 8 x 25 mm		



PRO-MED

27.1480

Laminektomiesperrer Aluminium
Laminectomy retractor only Aluminium
Ecarteur pour laminectomie Aluminium
Separador para laminectomia Aluminium
Divaricatore per laminectomia Aluminium

bestehend aus:

27.1481 Sperrer alleine
27.1485 - 2 Paar Valven 40 x 12 mm
27.1486 - 2 Paar Valven 50 x 12 mm
27.1487 - 2 Paar Valven 65 x 12 mm

consisting of:

27.1481 Retractor only
27.1485 - 2 pairs of valves 40 x 12 mm
27.1486 - 2 pairs of valves 50 x 12 mm
27.1487 - 2 pairs of valves 65 x 12 mm

comprenant:

27.1481 Ecarteur seul
27.1485 - 2 paires de valves 40 x 12 mm
27.1486 - 2 paires de valves 50 x 12 mm
27.1487 - 2 paires de valves 65 x 12 mm

compuesto de:

27.1481 Separador suelto
27.1485 - 2 pares valvas 40 x 12 mm
27.1486 - 2 pares valvas 50 x 12 mm
27.1487 - 2 pares valvas 65 x 12 mm

composta da:

27.1481 Separatore solo
27.1485 - 2 paia di valve 40 x 12 mm
27.1486 - 2 paia di valve 50 x 12 mm
27.1487 - 2 paia di valve 65 x 12 mm

Ersatzvalven
Spare valves
Valves de rechange
Valvas di ricambio
Valve die ricambio



27.1485 40 x 12 mm

27.1486 50 x 12 mm

27.1487 65 x 12 mm

Paar
pair
paire
par
paio

27.1481

Sperrer allein / Spreader only / Ecarteur seul /
Separador suelto / Divaricatore solo



CLOWARD

27.1451

16 cm

Spreizweite	15 mm
opening	15 mm
écartement	15 mm
abertura	15 mm
apertura	15 mm



CLOWARD

27.1455

13 cm

Spreizweite	20 mm
opening	20 mm
écartement	20 mm
abertura	20 mm
apertura	20 mm



INGE-BABY

17 cm

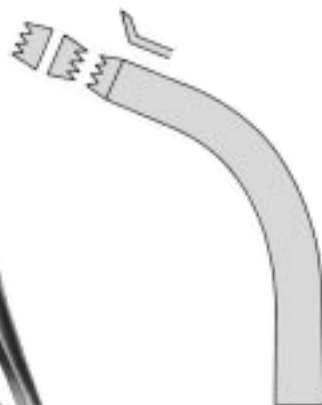

27.1460



27.1461



INGE
27 cm

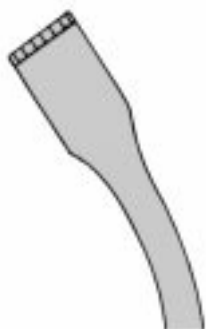

27.1465
9 mm

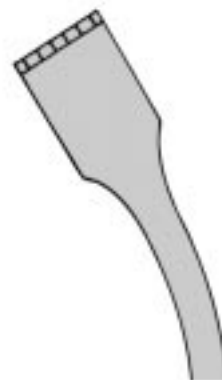

27.1466
12 mm



CASPAR
27.5050

Sperrer komplett mit 5 Valven 27.5062, 27.5072 - 27.5076
Retractor complete with 5 blades 27.5062, 27.5072 - 27.5076
Ecarteur complet avec 5 valves 27.5062, 27.5072 - 27.5076
Separador completo con 5 valvas 27.5062, 27.5072 - 27.5076
Divaricatore completo con 5 valve 27.5062, 27.5072 - 27.5076

27.5051

Sperrer allein / retractor only / ecarteur seul
separador solamente / divaricatore solo



27.5062 38 mm



27.5063 58 mm



- 27.5071** 32 x 22 mm
- 27.5072** 37 x 22 mm
- 27.5073** 43 x 22 mm
- 27.5074** 47 x 22 mm
- 27.5075** 52 x 22 mm
- 27.5076** 57 x 22 mm
- 27.5077** 62 x 22 mm
- 27.5078** 67 x 22 mm



- 27.5081** 32 x 37 mm
- 27.5082** 37 x 37 mm
- 27.5083** 43 x 37 mm
- 27.5084** 47 x 37 mm
- 27.5085** 52 x 37 mm
- 27.5086** 57 x 37 mm
- 27.5087** 62 x 37 mm
- 27.5088** 67 x 37 mm



- 27.5091** 32 x 52 mm
- 27.5092** 37 x 52 mm
- 27.5093** 43 x 52 mm
- 27.5094** 47 x 52 mm
- 27.5095** 52 x 52 mm
- 27.5096** 57 x 52 mm
- 27.5097** 62 x 52 mm
- 27.5098** 67 x 52 mm



CASPAR

17 cm

27.5000

Sperrer komplett mit 7 Valven 27.5021 - 27.5027

Retractor complete with 7 blades 27.5021 - 27.5027

Ecarteur complet avec 7 valves 27.5021 - 27.5027

Separador completo con 7 valvas 27.5021 - 27.5027

27.5001

Sperrer allein / retractor only

ecarteur seul / separador solamente

27.5021 40 mm



27.5022 45 mm



27.5023 50 mm



27.5024 55 mm



27.5025 60 mm



27.5026 65 mm



27.5027 70 mm





CASPAR
27.5100

Sperrer komplett mit 5 Valven 27.5183 - 27.5187
 Retractor complete with 5 blades 27.5183 - 27.5187
 Ecarteur complet avec 5 valves 27.5183 - 27.5187
 Separador completo con 5 valvas 27.5183 - 27.5187
 Divaricatore completo con 5 valve 27.5183 - 27.5187

27.5101

Sperrer allein / retractor only
 ecarteur seul / separador solamente / divaricatore solo



CASPAR
27.5110

Sperrer komplett mit 5 Valven 27.5183 - 27.5187
 Retractor complete with 5 blades 27.5183 - 27.5187
 Ecarteur complet avec 5 valves 27.5183 - 27.5187
 Separador completo con 5 valvas 27.5183 - 27.5187
 Divaricatore completo con 5 valve 27.5183 - 27.5187

27.5111

Sperrer allein / retractor only
 ecarteur seul / separador solamente / divaricatore solo



CASPAR
27.5120

Cervicalsperrer mit je 1 Valve
 27.5132 - 27.5136; 27.5152 - 27.5156

Cervical Retractor complete with 1 ea. Valve
 27.5132 - 27.5136; 27.5152 - 27.5156

Ecarteur cervical complet avec 1 chacun
 27.5132 - 27.5136; 27.5152 - 27.5156

Separador cervical completo con 1 c/u
 27.5132 - 27.5136; 27.5152 - 27.5156

Divaricatore completo con 1 ciascuno
 27.5132 - 27.5136; 27.5152 - 27.5156

27.5121

Sperrer allein / retractor only
 ecarteur seul / separador solamente /
 Divaricatore solo

Valven für CASPAR Sperrer
 Blades for CASPAR retractors
 Valves pour écarteurs CASPAR
 Valvas para separadores CASPAR
 Valve per divaricatore CASPAR



CASPAR TITANIUM

- 27.5122 40 x 25 mm
- 27.5123 45 x 25 mm
- 27.5124 50 x 25 mm
- 27.5125 55 x 25 mm
- 27.5126 60 x 25 mm

MEDIAL



CASPAR

- 27.5152 40 x 23 mm
- 27.5153 45 x 23 mm
- 27.5154 50 x 23 mm
- 27.5155 55 x 23 mm
- 27.5156 60 x 23 mm

LATERAL



CASPAR

- 27.5132 40 x 23 mm
- 27.5133 45 x 23 mm
- 27.5134 50 x 23 mm
- 27.5135 55 x 23 mm
- 27.5136 60 x 23 mm

MEDIAL



CASPAR

- 27.5164 50 x 25 mm
- 27.5166 60 x 25 mm



CASPAR TITANIUM

- 27.5142 40 x 25 mm
- 27.5143 45 x 25 mm
- 27.5144 50 x 25 mm
- 27.5145 55 x 25 mm
- 27.5146 60 x 25 mm

LATERAL



CASPAR

- 27.5183 45 x 23 mm
- 27.5184 50 x 23 mm
- 27.5185 55 x 23 mm
- 27.5186 60 x 23 mm
- 27.5187 65 x 23 mm



CASPAR

- 27.5199
- Pinzette zum Blattwechsel
- Forceps for changing valves
- Pince pour changer les valves
- Pinza para cambiari valvas
- Pinza per cambiare valve



- 27.5401 45 mm
- 27.5402 50 mm
- 27.5403 55 mm
- 27.5404 60 mm
- 27.5405 65 mm



modifiziertes Model
 improved model
 modèle modifié
 modelo modificado
 modello modific.

CASPAR
 27.5401 - 27.5405



CASPAR
 27.5440

Gegensperrer komplett bestehend aus:
 27.5441 Gegensperrer
 27.5430 - 27.5435 6 Valven 35, 40, 45, 50, 55, 60 mm
 Counter-Retractor complete, consisting of:
 27.5441 Counter Retractor
 27.5430 - 27.5435 6 Blades 35, 40, 45, 50, 55, 60 mm
 Contre-Ecarteur complet, comprenant:
 27.5441 Contre-Écarteur
 27.5430 - 27.5435 6 valves 35, 40, 45, 50, 55, 60 mm
 Contra-Separador completo, compuesto de:
 27.5441 Contra-separador
 27.5430 - 27.5435 6 valvas 35, 40, 45, 50, 55, 60 mm
 Contra-Divaricatore completo, composta da:
 27.5441 Contre-divaricatore
 27.5430 - 27.5435 6 valve 35, 40, 45, 50, 55, 60 mm

CASPAR
 27.5441

Gegensperrer alleine / Counter-Retractor only
 Contre-Ecarteur seul / Contra-Separador suelto
 Contra-Divaricatore solo



CASPAR



27.5030 45 mm



27.5031 50 mm



27.5032 55 mm



27.5033 60 mm



27.5034 65 mm



CASPAR

27.5420

Sperrer komplett mit 6 Valven 27.5430 - 27.5435
 Retractor complete with 6 blades 27.5430 - 27.5435
 Ecarteur complet avec 6 valves 27.5430 - 27.5435
 Separador completo con 6 valvas 27.5430 - 27.5435
 Divaricatore completo con 6 valve 27.5430 - 27.5435

27.5421

Sperrer allein / retractor only
 ecarteur seul / separador solamente / divaricatore solo

27.5430 35 mm



27.5431 40 mm



27.5432 45 mm



27.5433 50 mm



27.5434 55 mm



27.5435 60 mm



27.5436 65 mm



27.5437 75 mm



27.5438 85 mm





CASPAR

27.5500

Wirbelkörperdistraktor für Operationen an unterer und mittlerer Halswirbelsäule von rechts, bestehend aus:

- 27.5501 Distraktor
- 27.5509 Bohrlehre rechts
- 27.5520 Bohrer
- 27.5536 Distraktionsschrauben 16 mm (2 St.)
- 27.5550 Schraubendreher

Vertebral body distractor for surgical procedures of the cervical spine, from the right, consisting of:

- 27.5501 Distractor
- 27.5509 Drillguide, right
- 27.5520 Twist Drill
- 27.5536 Distraction screws 16 mm (2 pcs.)
- 27.5550 Screwdriver

Distracteur des corps vertébraux pour la chirurgie de la colonne cervicale, accès du côté droite, comprenant:

- 27.5501 Distracteur
- 27.5509 Guide-forets, droite
- 27.5520 Foret
- 27.5536 Vis à distraction 16 mm (2 pcs.)
- 27.5550 Tourne-vis

Distractor de los cuerpos vertebrales para la cirugía de la columna cervical, acceso del lado derecho, compuesto de:

- 27.5501 Distractor
- 27.5509 Guia para brocas, a la derecha
- 27.5520 Perforador
- 27.5536 Tornillos para distracción 16 mm (2 pzas.)
- 27.5550 Destornillador

Distrattore die corpi vertebrali per la chirurgia della colonna cervicale, acceso del lato destro, composta da:

- 27.5501 Distrattore
- 27.5509 Guide di perforatori, destra
- 27.5520 Perforatore
- 27.5536 Viti di distrazione 16 mm (2 pezzi)
- 27.5550 Cacciavite

27.5501

Distraktor alleine / Distractor only / Distracteur seul / Distractor suelto / Distrattore solo



27.5509

Bohrlehre, links für 27.5500
Drill Guide, left for 27.5500
Guide-forets, gauche pour 27.5500
Guia para brocas, a la izquierda para 27.5500
Guide di perforatori, sinistra - per 27.5500



27.5519

Bohrlehre, rechts für 27.5510
Drill Guide, right for 27.5510
Guide-forets, droite pour 27.5510
Guia para brocas, a la derecha para 27.5510
Guide di perforatori, destra - per 27.5510



CASPAR

27.5510

Wirbelkörperdistraktor für Operationen an unterer und mittlerer Halswirbelsäule von links, bestehend aus:

- 27.5511 Distraktor
- 28.5519 Bohrlehre links
- 27.5520 Bohrer
- 27.5536 Distraktionsschrauben 16 mm (2 St.)
- 27.5500 Schraubendreher

Vertebral body distractor for surgical procedures of the cervical spine, from the left, consisting of:

- 27.5511 Distractor
- 28.5519 Drillguide, right
- 27.5520 Twist Drill
- 27.5536 Distraction screws 16 mm (2 pcs.)
- 27.5500 Screwdriver

Distracteur des corps vertébraux pour la chirurgie de la colonne cervicale, accès du côté gauche, comprenant:

- 27.5511 Distracteur
- 28.5519 Guide-forets, gauche
- 27.5520 Foret
- 27.5536 Vis à distraction 16 mm (2 pcs.)
- 27.5500 Tourne-vis

Distractor de los cuerpos vertebrales para la cirugía de la columna cervical, acceso del lado izquierdo, compuesto de:

- 27.5511 Distractor
- 28.5519 Guia para brocas, a la izquierda
- 27.5520 Perforador
- 27.5536 Tornillos para distracción 16 mm (2 pzas.)
- 27.5500 Destornillador

Distrattore die corpi vertebrali per la chirurgia della colonna cervicale, acceso del lato sinistro, composta da:

- 27.5511 Distrattore
- 28.5519 Guide di perforatori, sinistra
- 27.5520 Perforatore
- 27.5536 Viti di distrazione 16 mm (2 pezzi)
- 27.5500 Cacciavite

27.5511

Distraktor alleine / Distractor only / Distracteur seul /
Distractor suelto / Distrattore solo



Bohrer
Drill
Mèche
Broca
Perforatore

CASPAR
27.5520
14,5 cm / 1,7 mm



Distraktionsschraube
Distraction screw
Vis à distraction
Tornillo para distracción
Viti di distrazione

CASPAR
27.5532 12 mm
27.5534 14 mm
27.5536 16 mm
27.5538 18 mm



Schraubenzieher
Screwdriver
Tourne-vis
Destornillador
Giravite

CASPAR
27.5550 20 cm



27.0700

LEYLA Retraktor Set 1-Arm
LEYLA Retractor Set 1-arm
LEYLA Ecarteur Jue 1-bras
LEYLA Separador Juego 1-brazo
LEYLA Divaricatore Set 1-braccio

bestehend aus:

27.0705 flexibler Spannarm
27.0706 Fixiervorrichtung für 1 Spannarm
27.0709 Spatelhalterung für flache Spateln

consisting of:

27.0705 flexible arm
27.0706 fixation base for 1 flexible arm
27.0709 support for flat spatulas

comprenant:

27.0705 bras tendeur flexibles
27.0706 étau crânien pour 1 bras flexible
27.0709 porte-spatules plates

compuesto de:

27.0705 brazo flexible
27.0706 dispositivo a fijación 1 brazo flexible
27.0709 soporte para espátulas llanas

composto da:

27.0705 braccio flessibile solo
27.0706 Fissatore per 1 braccio al cranio
27.0709 Sostegno per spatole piatte

27.0701

LEYLA Retraktor 2-Arme
LEYLA Retractor Set 2-arms
LEYLA Ecarteur Jue 2-bras
LEYLA Separador Juego 2-brazos
LEYLA Divaricatore Set 2-bracci

bestehend aus:

27.0705 2 flexible Spannarme
27.0707 1 Fixiervorrichtung für 2 Spannarme
27.0709 2 Spatelhalterungen für flache Spateln

consisting of:

27.0705 2 flexible arms
27.0707 1 fixation base for 2 flexible arms
27.0709 2 supports for flat spatulas

comprenant:

27.0705 2 bras tendeur flexibles
27.0707 1 étau crânien pour 2 bras flexibles
27.0709 2 portes-spatules plates

compuesto de:

27.0705 2 brazos flexibles
27.0707 1 dispositivo a fijación 2 brazos flexibles
27.0709 2 soportes para espátulas llanas

composto da:

27.0705 2 bracci flessibili
27.0707 1 Fissatore per bracci flessibili al cranio
27.0709 2 Sostegni per spatole piatte



27.0702

LEYLA Retraktor System zum Fixieren am OP-Tisch
 LEYLA Retractor System for fixation to Operating table
 LEYLA Ecarteur Système pour attacher à la table d'opération
 LEYLA Separador Sistema para fijar sobre la mesa de operaciones
 LEYLA Divaricatore Sistema per fissare all' tavolo operatorio

bestehend aus:

- 27.0705 LEYLA Spannarm allein
- 27.0709 LEYLA Flachspatelhalter
- 27.0711 LEYLA Haltearm starr
- 27.0712 LEYLA Kupplungskopf zur Aufnahme von 1 - 5 Spannarmen
- 27.0713 LEYLA Kugelgelenkkloben zum Befestigen des Haltearms am OP-Tisch
- 27.1031 HIRNSPATEL 200 / 9 mm
- 27.1032 HIRNSPATEL 200 / 12 mm

consisting of:

- 27.0705 LEYLA flexible arm only
- 27.0709 LEYLA Support f. flat Spatulas
- 27.0711 LEYLA Holding Rod rigid
- 27.0712 LEYLA coupling head for 1 - 5 flexible arms
- 27.0713 LEYLA Ball-and -socket joint for attaching Rod to operating table
- 27.1031 BRAIN SPATULA 200 / 9 mm
- 27.1032 BRAIN SPATULA 200 / 12 mm

comprenant:

- 27.0705 LEYLA bras tendeur flexible
- 27.0709 LEYLA porte-spatule pour spatules plats
- 27.0711 LEYLA potence, rigide
- 27.0712 LEYLA tete porte-bras pour 1 - 5 bras tendeur
- 27.0713 LEYLA Pièce de fixation pour attacher le bras à la table d'opération
- 27.1031 SPATULE cérébrale 200 / 9 mm
- 27.1032 SPATULE cérébrale 200 / 12 mm

compuesto de:

- 27.0705 LEYLA brazo flexible
- 27.0709 LEYLA porta-espátulas para espátulas planos
- 27.0711 LEYLA brazo rígido
- 27.0712 LEYLA cabeza porta-brazos para 1 - 5 brazos flexibles
- 27.0713 LEYLA Mecanismo para fijar el brazo sobre la mesa de operaciones
- 27.1031 ESPATULA cerebral 200 / 9 mm
- 27.1032 ESPATULA cerebral 200 / 12 mm

composto da:

- 27.0705 LEYLA braccio flessibile
- 27.0709 LEYLA Sostegno per spatole piatte
- 27.0711 LEYLA Braccio di fissaggio
- 27.0712 LEYLA Pezzo al combinare 1 - 5 bracci
- 27.0713 LEYLA Meccanismo per fissare il braccio all' tavolo operatorio
- 27.1031 SPATOLA cerebrale 200 / 9 mm
- 27.1032 SPATOLA cerebrale 200 / 12 mm

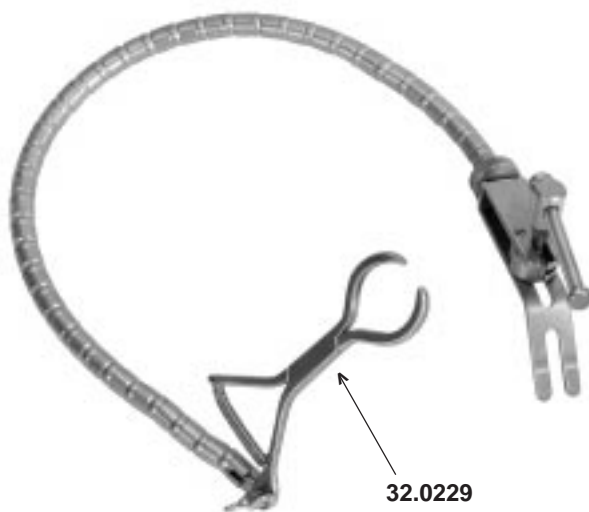

32.0220

LEYLA Ohrspekulahalter komplett

LEYLA Ear specula holder complete

LEYLA tendeur de spéculums auriculaires

LEYLA porta-especulos auriculares compl.

LEYLA Portaspecoli auricolari completo

32.0229

Ohrtrichterhalter

Ear specula holder

Tendeur de spéculums

Porta-especulos auriculares

Pinza portaspecoli auricolari

bestehend aus:

27.0705 LEYLA Spannarm allein

27.0708 LEYLA Fixiervorrichtung für Rohrteile

32.0229 LEYLA Ohrstrichterhalter

consisting of:

27.0705 LEYLA flexible arm only

27.0708 LEYLA Fixation base for mounting to bars

32.0229 LEYLA Ear specula holder

comprenant:

27.0705 LEYLA bras tendeur flexible

27.0708 LEYLA etau cranien simple pour attacher à potence etc.

32.0229 LEYLA Tendeur de spéculums

compuesto de:

27.0705 LEYLA brazo flexible

27.0708 LEYLA dispositivo a fijajion al brazo rigido

32.0229 LEYLA Porta-especulos auriculares

composto da:

27.0705 LEYLA braccio flessibile

27.0708 LEYLA Fissatore per 1 braccio al braccio

32.0229 LEYLA Pinza portaspecoli

27.0705

LEYLA Spannarm
flexible arm
Bras tendeur flexible
Brazo flexible
Braccio flessibile



27.0706

LEYLA Fixiervorrichtung für 1 Spannarm
fixation base for 1 flexible arm
étau crânien pour 1 bras flexible
dispositivo a fijación 1 brazo flexible
Fissatore per 1 braccio al cranio



27.0707

LEYLA Fixiervorrichtung für 2 Spannarme
fixation base for 2 flexible arms
étau crânien pour 2 bras flexibles
dispositivo a fijación 2 brazos flexibles
Fissatore per 2 bracci al cranio



27.0708

Fixiervorrichtung für 1 Spannarm 27.0705 zum Befestigen an Rohrteilen
Fixation base for 1 flexible arm 27.0205 for attaching to round bars
Pièce de fixation pour 1 bras 27.0205 aux tiges rondes
Fijador para 1 brazo 27.0705 para fijar al tubos
Fissatore per 1 braccio 27.0705 per il fissare al bracci rotondo



27.0709

LEYLA Flachspatelhalter
support for flat spatulas
porte-spatules plates
soporte para espátulas llanas
Sostegno per spatole piate



27.0710

LEYLA Rundspatelhalter
support for round spatulas
porte-spatules pour spatules ronds
porta-espátulas para espátulas rondos
Sostegno per spatole con asta rotonda



- 27.0711** LEYLA Haltearm starr
Holding Rod rigid
Potence, rigide
Brazo rigido
Braccio rigido



- 27.0712** Kupplungskopf zur Aufnahme von 1 - 5 Spannarmen 27.0705
Coupling head for 1-5 flexible arms 27.0705
tête porte-bras pour 1 - 5 bras tendeur 27.0705
cabeza porta-brazos para 1-5 brazos flexibles 27.0705
Pezzo al combinare 1 - 5 bracci 27.0705



- 27.0713** Kugelgelenkkolben zum Befestigen des Haltearms 27.0711 am OP-Tisch
Ball-and -socket joint for attaching Rod 27.0711 to operating table
Pièce de fixation pour attacher le bras 27.0711 à la table d'opération
Mecanismo para fijar el brazo 27.0711 sobre la mesa de operaciones
Meccanismo per fissare il braccio 27.0711 all' tavolo operatorio



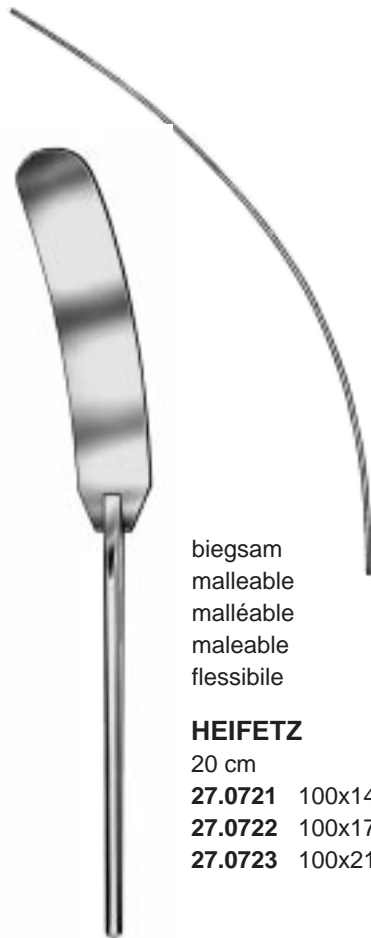

biegsam
 malleable
 malléable
 maleable
 flessibile

HEIFETZ

20 cm

27.0721 100x14 mm

27.0722 100x17 mm

27.0723 100x21 mm

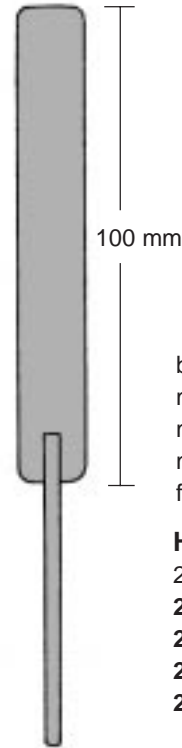

100 mm

biegsam
 malleable
 malléable
 maleable
 flessibile

HEIFETZ

20 cm

27.1026 8 mm

27.1027 11 mm

27.1028 14 mm

27.1029 17 mm



"AACHEN"

20 cm

27.1041 7/ 8 mm

27.1042 10/11 mm

27.1043 13/14 mm

27.1044 16/17 mm

27.1045 19/20 mm

27.1046 22/25 mm



DAVIS

18 cm

27.1050 6,0 mm

27.1051 9,5 mm

27.1052 13,5 mm

27.1053 16,0 mm

27.1054 19,0 mm

27.1055 25,0 mm

27.1056 32,0 mm

27.1057 38,0 mm



SCOVILLE

20 cm

27.1060 10/13 mm

27.1061 16/19 mm

biegsam / malleable / malléable / maleable / flessibile



27.1031 200 x 9 mm
27.1032 200 x 12 mm
27.1033 250 x 12 mm

biegsam
 malleable
 malléable
 maleable
 flessibile



27.1034 "MEMORY" 200 x 9 mm
27.1035 "MEMORY" 200 x 12 mm
27.1036 "MEMORY" 200 x 14 mm
27.1037 "MEMORY" 200 x 18 mm
27.1038 "MEMORY" 200 x 20 mm
27.1039 "MEMORY" 200 x 25 mm

biegsame "MEMORY"-Legierung
 malleable "MEMORY" alloy
 alliage flexible "MEMORY"
 aleación flexible "MEMORY"
 lega flessibile "MEMORY"



OLIVECRONA

konkav / concave
 concave / cóncavas
 concave

18 cm

27.1000 7 x 9 mm
27.1001 11 x 13 mm
27.1002 15 x 18 mm
27.1003 18 x 22 mm



OLIVECRONA

konvex / convex
 convexe / convexas
 convesse

18 cm

27.1005 7 x 9 mm
27.1006 11 x 13 mm
27.1007 15 x 18 mm
27.1008 18 x 22 mm



CUSHING

27.1010

17 cm 8 x 10 mm

27.1012

20 cm 13 x 15 mm



40.0670

a	b	c	d
55 mm	100 mm	170 mm	130 mm

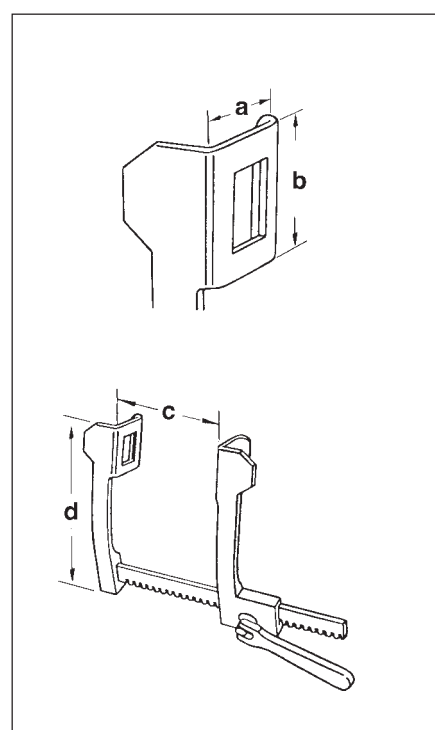



90x15 mm

MATHIEU
48.1030
 19,5 cm

ALAN-PARKS

48.1050 15 cm
 komplett
 complete
 complet
 completo

48.1051
 Sperrer allein
 retractor only
 ecarteur seul
 separador solamente
 divaricatore solo

48.1054
 95x24 mm
 Mittelvalve alleine
 Center blade only
 Valve centrale aeul
 Valva central solomenta
 Valva centrale solo



48.1052
 75 x 24 mm



48.1053
 95 x 24 mm



SMITH-BUIE
48.1060 15 cm



BARR
48.1070 17 cm



ST. MARKS
48.1080 22 cm



MILLIN
51.0020
28 cm



MILLIN
51.0080

komplett, mit 2 Seitenvalven 57x25 mm und 80x25 mm, 1 Mittelvale 120x45 mm
complete, with 2 lateral valves 57x25 mm and 80x25 mm, 1 center blade 120x45 mm
complet, avec 2 valves latérales 57x25 mm et 80x25 mm, 1 valve centrale 120x45 mm
completo, con 2 valvas laterales 57x25 mm y 80x25 mm, 1 valva central 120x45 mm
completo, con 2 valve laterali 57x25 mm e 80x25 mm, 1 valva centrale 120x45 mm



JUDD-MASSON
51.0070

Spreizweite 100 mm
spread 100 mm
ouverture 100 mm
apertura 100 mm
apertura 100 mm



JUDD-MASSON
51.0072

komplett, mit 2 Seitenvalven 70x25 mm und 1 Mittelvalve 84x24 mm
 complete, with 2 lateral valves 70x25 mm and 1 center blade 84x24 mm
 complet, avec 2 valves latérales 70x25 mm et 1 valve centrale 84x24 mm
 completo, con 2 valvas laterales 70x25 mm y 1 valva central 84x24 mm
 completo, con 2 valve laterali 70x25 mm e 1 valva centrale 84x24 mm



THOMSON-WALKER
51.0090

komplett, mit 2 Seitenvalven 70x25 mm und 75x25 mm, 1 Mittelvalve 90x25 mm
 complete, with 2 lateral valves 70x25 mm and 75x25 mm, 1 center blade 90x25 mm
 complet, avec 2 valves latérales 70x25 mm et 75x25 mm, 1 valve centrale 90x25 mm
 completo, con 2 valvas laterales 70x25 mm y 75x25 mm, 1 valva central 90x25 mm
 completo, con 2 valve laterali 70x25 mm e 75x25 mm, 1 valva centrale 90x25 mm



HRYNTSCHAK
51.0098

Rahmen allein
 Frame only
 Cadre seul
 Bastidor solo
 Telaio solo

HRYNTSCHAK
51.0099

Mittelvalve 35x100mm
 Center blade 35x100mm
 Valve centrale 35x100mm
 Valva central 35x100mm
 Valva centrale 35x100mm

HRYNTSCHAK
51.0097

Spreizweite 110 mm
 spread 110 mm
 ouverture 110 mm
 apertura 110 mm
 apertura 110 mm



KOGAN
55.0530 24 cm



KOGAN
55.0532 24 cm



LATERAL
55.0550
22 cm

NAHT
SUTURE
SUTURE
SUTURA
SUTURA





CASTROVIEJO



18.0800 14 cm
18.0802 18 cm
18.0804 22 cm

18.1800 14 cm
18.1802 18 cm
18.1804 22 cm



18.0810
18.0812
18.0814

18.1810
18.1812
18.1814



18.0801 14 cm
18.0803 18 cm
18.0805 22 cm

18.1801 14 cm
18.1803 18 cm
18.1805 22 cm



18.0811
18.0813
18.0815

18.1811
18.1813
18.1815



CASTROVIEJO



CASTROVIEJO
18.0840 13 cm



CASTROVIEJO
18.1840 13 cm



BOYNTON
18.1850 12 cm



18.0860

ARRUGA
16 cm



18.0861



18.1860

ARRUGA
16 cm



18.1861



18.1864

ARRUGA
14 cm



18.1865



KALT
18.0870 14 cm



KALT
18.1870 14 cm



KALT-ARRUGA
18.1875 14 cm





STEVENS
 18.1880 11 cm



STEVENS
 18.1884 13 cm
 18.1886 15 cm



COHAN
 18.1940
 7,5 cm
 gebogen ohne Sperre
 curved without lock
 courbe sans arrêt
 curvo sin cierre
 curvo senza caramagliera



COHAN
 18.1942
 7,5 cm
 gebogen mit Sperre
 curved with lock
 courbe avec arrêt
 curvo con cierre
 curvo con caramagliera



18.1912



18.1913

BARRAQUER-TROUTMANN
 10 cm



18.1914



18.1915

BARRAQUER-TROUTMANN
 10 cm



BARRAQUER
 18.1910 13 cm



BARRAQUER
 18.1911 11 cm



BARRAQUER
 18.1900
 12 cm



BARRAQUER
 18.1901
 12 cm



BARRAQUER
 18.1902
 12 cm



BARRAQUER
 18.1903
 12 cm



BARRAQUER
 18.1917
 14 cm



18.1920 18.1921

CASTROVIEJO-MICRO
 9 cm



18.1924 18.1925

CASTROVIEJO-MICRO
 9 cm



18.1930 18.1931

CASTROVIEJO-MICRO
 14 cm



18.1932 18.1933

CASTROVIEJO-MICRO
 14 cm



28.3100
15 cm



28.3101
15 cm



28.3102
15 cm



28.3103
15 cm

REILL

REILL



ohne Sperre
without lock
sens arrêt
sin cierre
senza caramagliera



28.3130
12,5 cm / Ø 7 mm
gerade
straight
droit
recto
retto

28.3131
12,5 cm / Ø 7 mm
gebogen
curved
courbe
curvo
curvo



mit Sperre
with lock
avec arrêt
con cierre
con caramagliera



28.3132
12,5 cm / Ø 7 mm
gerade
straight
droit
recto
retto

28.3133
12,5 cm / Ø 7 mm
gebogen
curved
courbe
curvo
curvo



28.3140
15 cm / Ø 8 mm

28.3150
18 cm / Ø 8 mm

gerade
straight
droit
recto
retto



28.3141
15 cm / Ø 8 mm

28.3151
18 cm / Ø 8 mm

gebogen
curved
courbe
curvo
curvo



28.3142
15 cm / Ø 8 mm

28.3152
18 cm / Ø 8 mm

gerade mit Sperre
straight with lock
droit avec arrêt
recto con cierre
retto con caramagliera



28.3143
15 cm / Ø 8 mm

28.3153
18 cm / Ø 8 mm

gebogen mit Sperre
curved with lock
courbe avec arrêt
curvo con cierre
curvo con caramagliera



mit Sperre
with lock
avec arrêt
con cierre
con caramagliera

21 cm

28.3154
gerade
straight
droit
recto
retto

28.3155
gebogen
curved
courbe
curvo
curvo



mit Sperre
with lock
avec arrêt
con cierre
con caramagliera

23 cm

28.3156
gerade
straight
droit
recto
retto

28.3157
gebogen
curved
courbe
curvo
curvo



15 cm

28.3242
gerade
straight
droit
recto
retto

28.3243
gebogen
curved
courbe
curvo
curvo



18 cm

28.3252
gerade
straight
droit
recto
retto

28.3253
gebogen
curved
courbe
curvo
curvo



21 cm

28.3254

gerade
straight
droit
recto
retto

28.3255

gebogen
curved
courbe
curvo
curvo



23 cm

28.3256

gerade
straight
droit
recto
retto

28.3257

gebogen
curved
courbe
curvo
curvo



JACOBSON



28.3400
18,5 cm
28.3402
21 cm
28.3404
23 cm



JACOBSON



28.3406
18,5 cm
28.3408
21 cm



MIKRO-
NADELHALTER



28.3450
23 cm



28.3451
23 cm



Diamantbeschichtete Spitzen
Diamond coated tips
Avec bouts de diamant
Puntas con cascós de diamante
Morsi con rivestimento di diamante



Maul 2 mm breit gerieft
Jaws 2 mm wide serrated
mors 2 mm, dentelées
boca 2 mm, dentadas
morso 2 mm, dentate

28.3662

18 cm / 10 mm

28.3664

21 cm / 10 mm

GREGORY



28.3662D

18 cm / 10 mm

28.3664D

21 cm / 10 mm























GREGORY

TITANIUM



Diamantbeschichtete Spitzen
 Diamond coated tips
 Avec bouts de diamant
 Puntas con cascos de diamante
 Morsi con rivestimento di diamante

ohne Sperre
 without lock
 sens arrêt
 sin cierre
 senza caramagliera







							
0,4mm				0,4mm			
15 cm	28.3600	28.3600SD	28.3600S	15 cm	28.3601	28.3601SD	28.3601S
18 cm	28.3602	28.3602SD	28.3602S	18 cm	28.3603	28.3603SD	28.3603S
21 cm	28.3604	28.3604SD	28.3604S	21 cm	28.3605	28.3605SD	28.3605S
23 cm	28.3606	28.3606SD	28.3606S	23 cm	28.3607	28.3607SD	28.3607S
							
0,8mm				0,8mm			
15 cm	28.3610	28.3610SD	28.3610S	15 cm	28.3611	28.3611SD	28.3611S
18 cm	28.3612	28.3612SD	28.3612S	18 cm	28.3613	28.3613SD	28.3613S
21 cm	28.3614	28.3614SD	28.3614S	21 cm	28.3615	28.3615SD	28.3615S
23 cm	28.3616	28.3616SD	28.3616S	23 cm	28.3617	28.3617SD	28.3617S
TITANIUM				TITANIUM			







TITANIUM









Diamantbeschichtete Spitzen
 Diamond coated tips
 Avec bouts de diamant
 Puntas con cascós de diamante
 Morsi con rivestimento di diamante







mit Sperre
 with lock
 avec arrêt
 con cierre
 con arresto

			
0,4mm			
15 cm	28.3630	28.3630SD	28.3630S
18 cm	28.3632	28.3632SD	28.3632S
21 cm	28.3634	28.3634SD	28.3634S
23 cm	28.3636	28.3636SD	28.3636S

			
0,4mm			
15 cm	28.3631	28.3631SD	28.3631S
18 cm	28.3633	28.3633SD	28.3633S
21 cm	28.3635	28.3635SD	28.3635S
23 cm	28.3637	28.3637SD	28.3637S

			
0,8mm			
15 cm	28.3640	28.3640SD	28.3640S
18 cm	28.3642	28.3642SD	28.3642S
21 cm	28.3644	28.3644SD	28.3644S
23 cm	28.3646	28.3646SD	28.3646S

TITANIUM

			
0,8mm			
15 cm	28.3641	28.3641SD	28.3640S
18 cm	28.3643	28.3643SD	28.3642S
21 cm	28.3645	28.3645SD	28.3644S
23 cm	28.3647	28.3647SD	28.3647S

TITANIUM

TITANIUM



Diamantbeschichtete Spitzen
 Diamond coated tips
 Avec bouts de diamant
 Puntas con cascos de diamante
 Morsi con rivestimento di diamante

ohne Sperre
 without lock
 sens arrêt
 sin cierre
 senza caramagliera

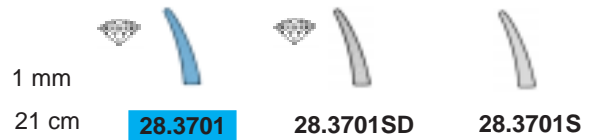

TITANIUM

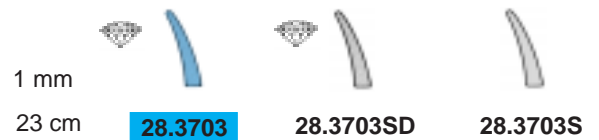

TITANIUM



28.3504 20,0 cm
28.3506 22,0 cm



28.3501 16,0 cm
28.3505 20,0 cm
28.3507 22,0 cm
28.3509 24,0 cm



28.3520 16,0 cm
28.3522 18,0 cm



28.3521 16,0 cm
28.3523 18,0 cm



DERF
 18.0010 12 cm



HALSEY-MICRO
 12 cm



HALSEY
 13 cm

18.0016

18.0018
 glatt
 smooth
 lisse
 lisa
 liscio

18.0020
 18.0020 L
 für Linkshänder
 for left-handers
 pour gauchers
 para zurdos
 per mono sinistra

18.0025
 glatt
 smooth
 lisse
 lisa
 liscio



WEBSTER
 13 cm



BAUMGARTNER
 18.0030 14 cm



KILNER
 13 cm

18.0026
 glatt
 smooth
 lisse
 lisa
 liscio

18.0029

18.0040

18.0042
 glatt
 smooth
 lisse
 lisa
 liscio



NEIVERT
18.0050 12 cm



BABY-CRILE-WOOD
18.0069 15 cm



CRILE-WOOD

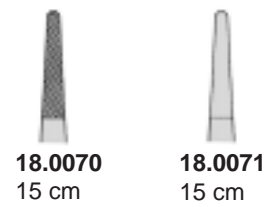

18.0070
15 cm

18.0071
15 cm

18.0070L
15 cm
für Linkshänder
for left-handers
pour gauchers
para zurdos
per mono sinistra



18.0072
18 cm



18.0074
20 cm



18.0076
23 cm

18.0072L
18 cm

18.0074L
20 cm

18.0076L
23 cm

für Linkshänder / for left-handers / pour gauchers
para zurdos / per mono sinistra

TITANIUM

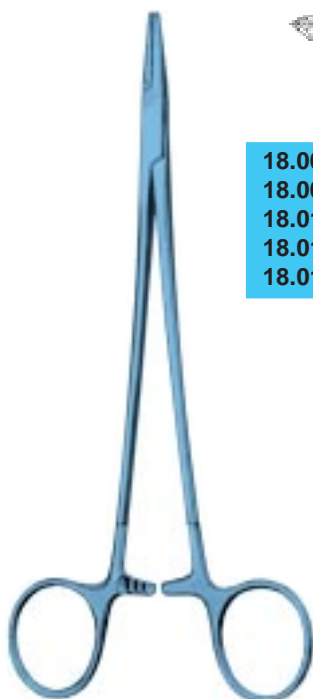

MICRO-VASCULAR







- 18.0016TD** 12,5 cm
- 18.0070TD** 14,5 cm
- 18.0100TD** 17,5 cm
- 18.0102TD** 19,5 cm
- 18.0104TD** 22,5 cm

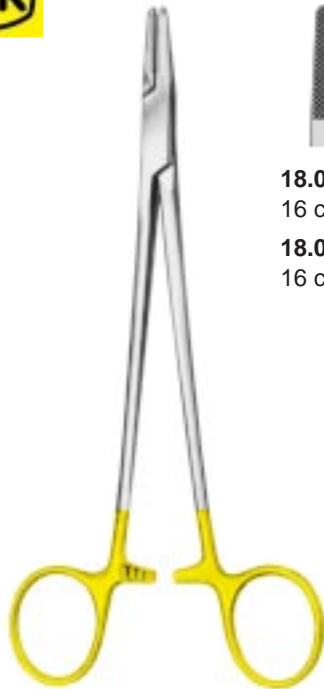





Diamantbeschichtete Spitzen
 Diamond coated tips
 Avec bouts de diamant
 Puntas con cascós de diamante
 Morsi con rivestimento di diamante



MAYO-HEGAR

				
18.0080 16 cm	18.0082 18 cm	18.0084 20 cm	18.0086 24 cm	18.0088 26 cm
18.0080L 16 cm	18.0082L 18 cm	18.0084L 20 cm	18.0086L 24 cm	18.0088L 26 cm

für Linkshänder / for left-handers / pour gauchers / para zurdos / per mono sinistra

			
18.0090 30 cm	18.0092 35 cm	18.0094 37 cm	18.0096 40 cm

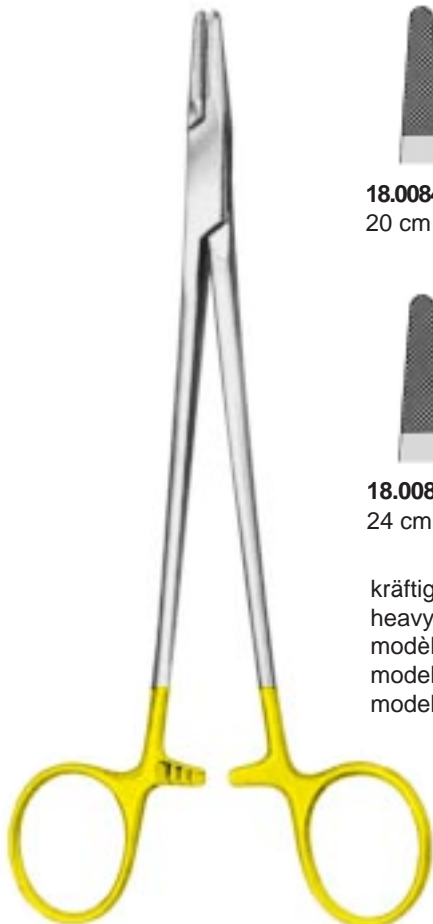

MAYO-HEGAR





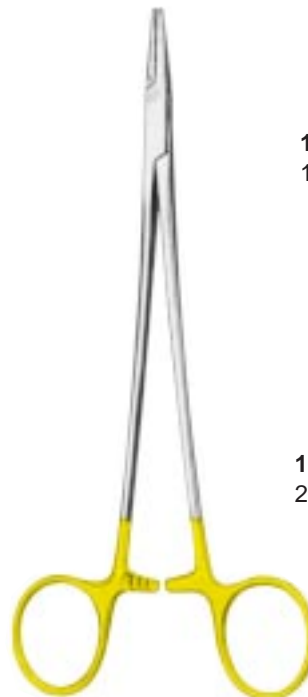

18.0084HP
20 cm

18.0086HP
24 cm

kräftige Modelle
 heavy patterns
 modèles forts
 modelos robustos
 modelli robusti



DEBAKEY

		
18.0100 18 cm	18.0102 20 cm	18.0104 23 cm
		
18.0106 26 cm	18.0108 30 cm	18.0110 37 cm



Diamantbeschichtete Spitzen
 Diamond coated tips
 Avec bouts de diamant
 Puntas con cascós de diamante
 Morsi con rivestimento di diamante



DEBAKEY-SELECT



JULIAN

18.0113 20 cm
18.0115 23 cm



NEW ORLEANS

18.0120
18 cm



MICRO-VASCULAR



MICRO-VASCULAR-SELECT



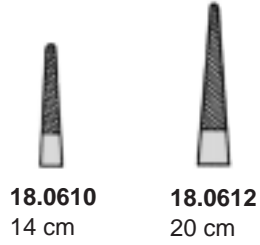

INTRACARDIAC

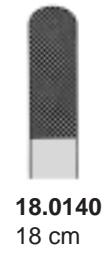

BERRY STERNAL



TOENNIS
 18.0142 18 cm
 18.0144 20 cm



18.0146
18 cm

18.0148
20 cm

TOENNIS-RYDER



LANGENBECK

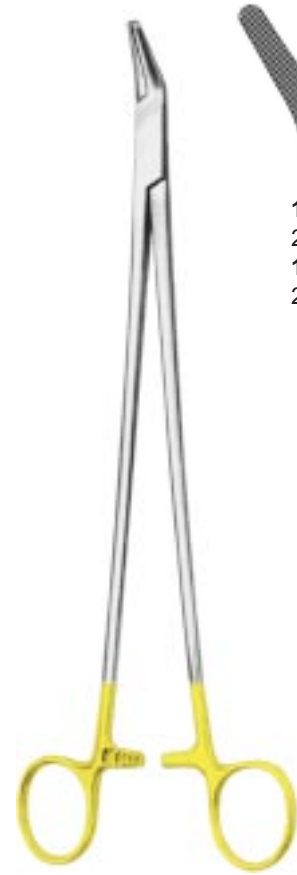
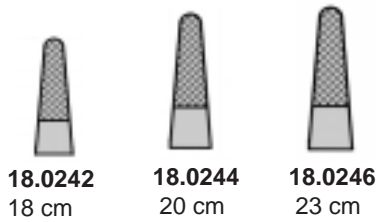

FINOCHIETTO



18.0150
21 cm
18.0152
27 cm



BOZEMANN

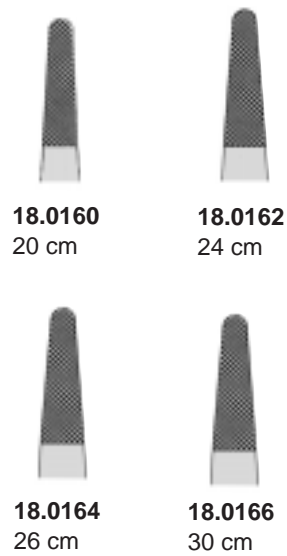



MASSON
18.0170 27 cm



WANGENSTEEN
18.0180 28 cm



HEANEY



18.0190
20 cm



18.0192
24 cm



18.0194
26 cm



18.0202
21 cm



18.0204
23 cm

STRATTE



18.0210
15 cm

18.0212
18 cm

18.0214
27 cm

SAROT



18.0220
26 cm

NAUNTON-MORGAN



MATHIEU

18.0250
14 cm

18.0252
17 cm

18.0254
20 cm

18.0256
24 cm



MATHIEU

18.0260
14 cm

18.0262
17 cm

18.0264
20 cm

18.0266
23 cm

mit Innensperre
 with inside ratchet
 avec crémaillère interne
 con cremallera interior
 con cremagliera interna



MATHIEU-KOCHER

18.0270
14 cm

18.0272
17 cm

18.0274
20 cm



LICHTENBERG

18.0280
20 cm



HÖSEL
18.0286 20 cm
18.0288 25 cm



HÖSEL
18.0289 25 cm



FOSTER-GILLIES
18.0310 12 cm
18.0310L 12 cm
für Linkshänder
for left-handers
pour gauchers
para zurdos
per mano sinistra



18.0320
15,5 cm

GILLIES-MINI



18.0322
16 cm

GILLIES



18.0330 12 cm
18.0330L 12 cm
 für Linkshänder
 for left-handers
 pour gauchers
 para zurdos
 per mano sinistra

OLSEN-HEGAR



18.0332
14 cm

18.0334
16,5 cm

18.0336
18,5 cm

OLSEN-HEGAR



18.0340
12 cm
 gerieft
 serrated
 strié
 estriada
 con striatura

KAYE

18.0341
12 cm
 glatt
 smooth
 lisse
 lisa
 liscio

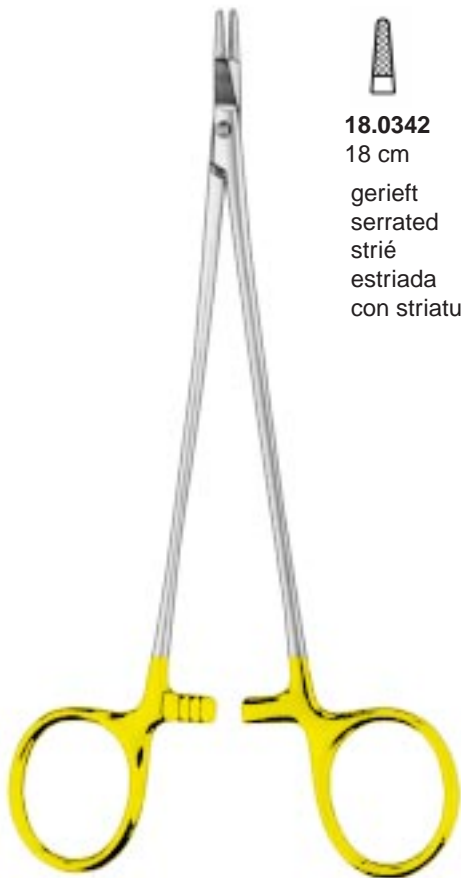

KAYE



18.0342
 18 cm
 gerieft
 serrated
 strié
 estriada
 con striatura



18.0343
 18 cm
 glatt
 smooth
 lisse
 lisa
 liscio

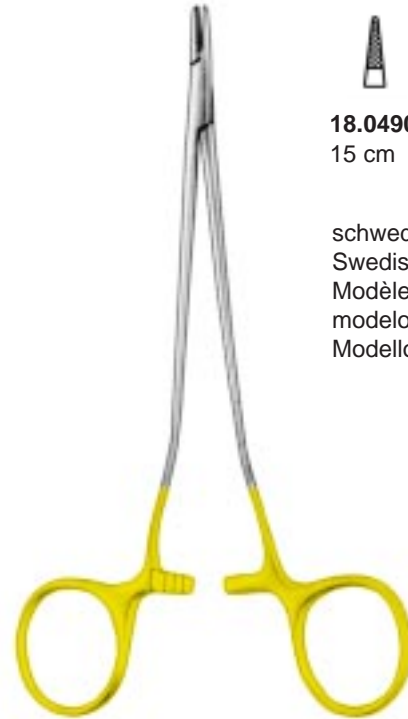

PRO-MED



18.0490
 15 cm

schwedisches Modell
 Swedish model
 Modèle suédoise
 modelo sueco
 Modello svedese



RYDER



18.0530
 13 cm



18.0532
 15 cm



18.0534
 18 cm



18.0536
 20 cm



18.0538
 23 cm



18.0540
 26 cm

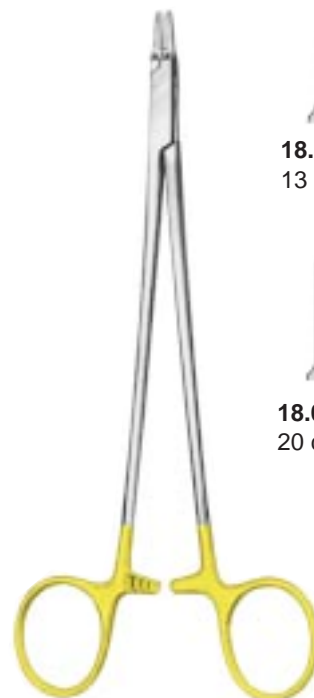

RYDER-MINI



18.0550
 13 cm



18.0552
 15 cm



18.0554
 18 cm



18.0556
 20 cm



18.0558
 23 cm



18.0560
 25 cm



Diamantbeschichtete Spitzen
Diamond coated tips
Avec bouts de diamant
Puntas con cascós de diamante
Morsi con rivestimento di diamante



RYDER-MINI-SELECT

18.0552D 15 cm
18.0554D 18 cm
18.0556D 20 cm
18.0558D 23 cm



DIETRICH

18.0600 18 cm
18.0602 20 cm
18.0604 23 cm
18.0606 26 cm



18.1010
12 cm

DERF



18.1012
12,5 cm



COLLIER
18.1015 12,5 cm



HALSEY
13 cm



18.1020



18.1025



WEBSTER
18.1026 13 cm



BAUMGARTNER
18.1030 14 cm



DOYEN
18.1035 12,5 cm



KILNER
18.1040 13 cm



Maul glatt mit Spezialkehle
 Smooth jaws, with special groove
 Mâchoires lisses, avec cannelure spécial
 Bocas lisas, con acanaladura especial
 morso liscio con scannellatura speciale



NEIVERT
 18.1050 12 cm



CRILE
 18.1060 15 cm



CRILE-MURRAY
 18.1065 15 cm



CRILE-WOOD
 18.1070 15 cm



CRILE-WOOD

18.1072
 18 cm

18.1074
 20 cm

18.1076
 23 cm

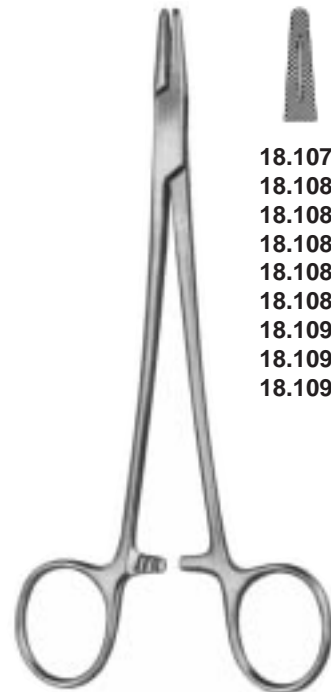

MAYO-HEGAR

- 18.1078** 14 cm
- 18.1080** 16 cm
- 18.1082** 18 cm
- 18.1084** 20 cm
- 18.1086** 24 cm
- 18.1088** 26 cm
- 18.1090** 30 cm
- 18.1092** 35 cm
- 18.1094** 40 cm



METZENBAUM
18.1100 18 cm



ADSON
18.1110 18 cm



FINOCHIETTO
18.1152 21 cm
18.1154 27 cm



JOHNSON
18.1160 27 cm



JOHNSON
18.1161 20 cm
18.1162 24 cm
18.1164 26 cm



MASSON
18.1170 27 cm



WANGENSTEEN
18.1180 27 cm



HEANEY (HEGAR)
18.1190 20 cm



STRATTE
18.1200 23 cm



SAROT
18.1212 18 cm
18.1214 26 cm



18.1250
14 cm



18.1252
17 cm



18.1254
20 cm



MATHIEU



18.1260 14 cm
18.1262 17 cm



MATHIEU-SLIM



mit Innensperre
with inside ratchet
avec crémaillère interne
con cremallera interior
con cremagliera interna



MATHIEU
18.1270 14 cm
18.1272 17 cm
18.1274 20 cm



GILLIES-MINI
18.1320 16 cm



GILLIES
18.1322 15 cm



OLSEN-HEGAR
18.1330 12 cm
18.1330L 12 cm



für Linkshänder/for left-handers/pour gauchers
para zurdos/per mono sinistra



OLSEN-HEGAR
18.1332 14 cm
18.1334 16,5 cm
18.1336 18 cm



MICHEL
18.3000
12 cm



MICHEL
18.3010
12 cm



MICHEL-FINO
18.3015
12 cm



CHILDE
18.3020
14,5 cm



CHILDE
18.3022
17,5 cm



HEGENBARTH
18.3050
12,5 cm



WACHENFELDT
18.3060
12 cm



WACHENFELDT
18.3065
12 cm



mm	1000 Stück/pieces pièces/piezas/pezzi
7,5 x 1,75	18.3071
11 x 2	18.3072
12 x 3	18.3074
14 x 3	18.3075
16 x 3	18.3076
18 x 3	18.3077
20 x 3	18.3078
22 x 3	18.3079

MICHEL

Fadenpinzetten
 Suture Forceps
 Pinces à sutures
 Pinzas para suturas
 Pinze per sutura



COLLIN
 18.3100 14 cm



RICHTER-HEATH
 18.3110 14 cm



OCHSNER
 18.3130 14 cm



CORN
 18.3140 15 cm



18.3150 16 cm/Ø1,6 mm
18.3152 16 cm/Ø2,2 mm

Wundklammerbesteck
Suture Clip Set
Trousse à agrafes
Juego de agrafes
Set per fermagli



MICHEL
18.3300

bestehend aus:

MICHEL Wundklammerpinzette 12 cm
WACHENFELDT Wundrandfaßpinzette
MICHEL Wundklammern 12x3 mm
Metalletui

consisting of:

MICHEL Clip Forceps
WACHENFELDT Approximation Forceps
MICHEL Clips 12x3 mm
Metal case

comprenant:

MICHEL Pince à poser agrafes
WACHENFELDT Pince à affronter
MICHEL Agrafes 12x3mm
Boîte en métal

compuesto de:

MICHEL Pinza p. poner grapas
WACHENFELDT Pinza aproximadora
MICHEL Grapas 12x3mm
Caja metálica

composto di:

MICHEL Pinza p. applicare le agrafe
WACHENFELDT Pinza per avvicinare
MICHEL Agrafe 12x3 mm
Scatola metallica



POCKET-MINI
18.3340

Nahtbesteck bestehend aus:

- 1 MATHIEU Nadelhalter 14 cm
- 1 Packung Nähseide steril
- 3 Nähnadeln, verschiedene Grössen
- 1 Nadeldose gelocht
- 1 MICHEL Wundklammerzängchen
- 20 MICHEL Wundklammern auf Halter
- 1 Skalpellgriff # 4
- 3 Skalpellklingen, verschiedene Grössen
- 1 chirurgische Schere, 13 cm, gerade sp/st
- 1 anatomische Pinzette 12,5 cm
- Metalletui

Suture Set consisting of:

- 1 MATHIEU needle holder 14 cm
- 1 package of silk, sterile
- 3 surgical needles, different sizes
- 1 needle case, perforated
- 1 MICHEL suture clip forceps
- 20 MICHEL suture clips, on clip holder
- 1 scalpel handle # 4
- 3 scalpel blades, different sizes
- 1 operating scissors 13 cm straight sh/bl
- 1 dressing forceps 12,5 cm
- metal case

Trousse à suture comprenant:

- 1 porte-aiguille MATHIEU, 14 cvm
- 1 flacon de soie à suture, stérile
- 3 aiguilles à suture, assorties
- 1 boîte pour aiguilles, perforée
- 1 pince à agrafes MICHEL
- 20 agrafes MICHEL, sur porte-agrales
- 1 manche à bistouri # 4
- 3 lames de bistouris, assorties
- 1 ciseaux 13 cm, droits, pt/mo
- 1 pince à dissection 12,5 cm
- boîte métal

Estuche para suturas compuesto de:

- 1 MATHIEU porta-agujas 14 cm
- 1 paquete de seda, estéril
- 3 agujas diferentes para suturas
- 1 cajita perforada para agujas
- 1 MICHEL pinza para agrafes
- 20 MICHEL agrafes, en dispositivo
- 1 mango de bisturi # 4
- 3 hojas diferentes de bisturi
- 1 tijera, 13 cm recta, ag./ro.
- 1 pinza de disección 12,5 cm
- caja metálica

Set per sutura composto di:

- 1 MATHIEU portaghi 14 cm
- 1 flacone de seta per sutura, sterile
- 3 aghi assortiti per sutura
- 1 astuccio per aghi, perforato
- 1 MICHEL pinza per agrafes
- 20 MICHEL agrafes, con supporto
- 1 manico per bisturi # 4
- 3 lame per bisturi, assortite
- 1 forbice chirurgica, 13 cm retta, ap/sm
- 1 pinza anatomica 12,5 cm
- contenitore metallico

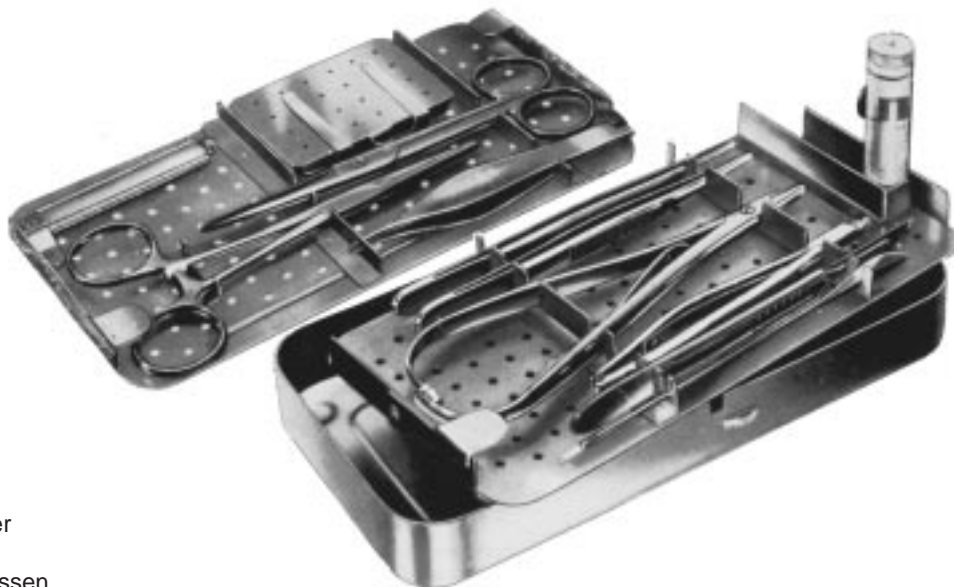

POCKET-MULTI
18.3345

Nahtbesteck bestehend aus:

- 1 MATHIEU Nadelhalter 17 cm
- 1 Packung Nähseide steril
- 6 verschiedene Nähnadeln
- 1 Nadeldose gelocht
- 1 MICHEL Wundklammerzängchen
- 20 MICHEL Wundklammern auf Halter
- 1 Skalpellgriff # 4
- 4 Skalpellklingen, verschiedene Grössen
- 1 chirurgische Schere, 14,5 cm, gerade sp/st
- 1 anatomische Pinzette 14,5 cm
- 1 chirurgische Pinzette 14,5 cm 1x2 Zähne
- 1 FEILCHENFELDT Splitterpinzette 11,5 cm
- 1 KOCHER Arterienklemme 14 cm, 1x2 Zähne
- 1 Myrtenblattsonde 13 cm
- Metalletui mit 2 herausnehmbaren Lagerungseinsätzen

Suture Set consisting of:

- 1 MATHIEU needle holder 17 cm
- 1 Package of silk, sterile
- 6 different surgical needles
- 1 needle case, perforated
- 1 MICHEL suture clip forceps
- 20 MICHEL suture clips
- 1 scalpel handle # 4
- 4 different scalpel blades
- 1 operating scissors 14,5 cm straight, sh/bl
- 1 dressing forceps 14,5 cm
- 1 dissecting forceps 14,5 cm 1x2 teeth
- 1 FEILCHENFELDT splinter forceps 11,5 cm
- 1 KOCHER artery forceps 14 cm 1x2 teeth
- 1 myrtle leaf probe 13 cm
- metal case with 2 perforated storage trays

Trousse à suture comprenant:

- 1 MATHIEU porte-aiguille 17 cm
- 1 flacon de soie à suture, stérile
- 6 aiguilles à suture, assorties
- 1 boîte pour aiguilles, perforée
- 1 MICHEL Pince à agrafes
- 20 MICHEL agrafes, sur porte-agrales
- 1 manche à bistouri # 4
- 4 lames de bistouri, assorties
- 1 ciseaux 14,5 cm, droits pt/mo
- 1 pince à dissection 14,5 cm
- 1 pince à dissection 14,5 cm 1x2 dents
- 1 FEILCHENFELDT pince à écharde 11,5 cm
- 1 KOCHER Pince hémostatique 14 cm 1x2 dents
- 1 sonde mirtiliforme 13 cm
- boîte métal avec 2 plateaux perforés

Estuche para suturas compuesto de:

- 1 MATHIEU porta-agujas 17 cm
- 1 paquete de seda, estéril
- 6 agujas diferentes para suturas
- 1 cajita perforada para agujas
- 1 MICHEL pinza para agrafes
- 20 MICHEL agrafes, en dispositivo
- 1 mango de bisturi # 4
- 4 hojas diferentes de bisturi
- 1 tijera 14,5 cm recta ag/ro
- 1 pinza de disección 14,5 cm
- 1 pinza de disección 14,5 cm 1x2 dientes
- 1 FEILCHENFELDT Pinza para espinas 11,5 cm
- 1 KOCHER Pinza hemostática 14 cm, 1x2 dientes
- 1 sonda mirtiliforme 13 cm
- caja metálica con 2 bandejas perforadas para instrumentos

Set per sutura composto di:

- 1 MATHIEU porthagi 17 cm
- 1 flacone di seta per sutura, sterile
- 6 aghi assortiti per sutura
- 1 astuccio per aghi, perforato
- 1 MICHEL pinza per agrafes
- 20 MICHEL agrafes, con supporto
- 1 manico per bisturi # 4
- 4 lame per bisturi, assortite
- 1 forbice chirurgica retta, 14,5 cm retta, ap/sm
- 1 pinza anatomica 14,5 cm
- 1 pinza chirurgica 14,5 cm 1x2 denti
- 1 sonda mirtiliforme 13 cm
- caja metalica con 2 bacinelle perforate per gli strumenti

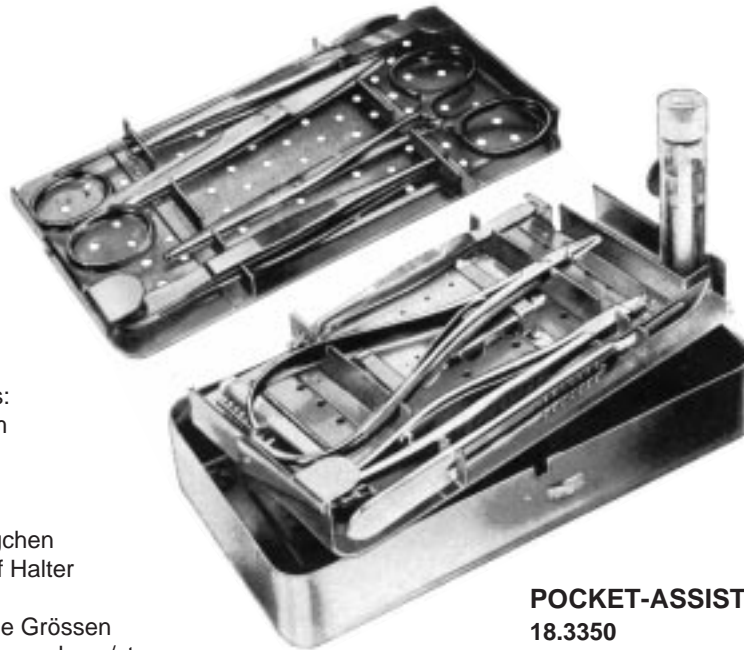

POCKET-ASSISTENT
18.3350

Taschenbesteck bestehend aus:

- 1 MATHIEU Nadelhalter 14 cm
- 1 Packung Nähseide, steril
- 6 verschiedene Nähnadeln
- 1 Nadeldose gelocht
- 1 MICHEL Wundklammerzängchen
- 20 MICHEL Wundklammern auf Halter
- 1 Skalpellgriff # 4
- 4 Skalpellklingen, verschiedene Größen
- 1 chirurgische Schere, 13 cm, gerade sp/st
- 1 anatomische Pinzette 11,5 cm
- 1 chirurgische Pinzette 12 cm 1x2 Zähne
- 1 HUNTER Splitterpinzette 10,5 cm
- 1 KOCHER Arterienklemme 13 cm, 1x2 Zähne
- 1 Myrtenblattsonde 13 cm
- Metalletui mit 2 herausnehmbaren Lagereinsätzen

Suture Set consisting of:

- 1 MATHIEU needle holder 14 cm
- 1 Package of silk, sterile
- 6 different surgical needles
- 1 needle case, perforated
- 1 MICHEL suture clip forceps
- 20 MICHEL suture clips on clip holder
- 1 scalpel handle # 4
- 4 different scalpel blades
- 1 operating scissors 13 cm straight sh/bl
- 1 dressing forceps 11,5 cm
- 1 dissecting forceps 12 cm, 1x2 teeth
- 1 HUNTER splinter forceps 10,5 cm
- 1 KOCHER artery forceps 13 cm, 1x2 teeth
- 1 myrtle leaf probe 13 cm
- metal case with 2 perforated storage trays

Trousse à suture comprenant:

- 1 MATHIEU porte-aiguille 14 cm
- 1 flacon de soie à suture, stérile
- 6 aiguilles à suture, assorties
- 1 boîte pour aiguilles, perforée
- 1 MICHEL Pince à agrafes
- 20 MICHEL agrafes, sur porte-agrafe
- 1 manche à bistouri # 4
- 4 lames de bistouri, assorties
- 1 ciseaux 13 cm, droits pt/mo
- 1 pince à dissection 11,5 cm
- 1 pince à dissection 12 cm 1x2 dents
- 1 HUNTER pince à échardes 10,5 cm
- 1 KOCHER pince hémostatique 13 cm, 1x2 dents
- 1 sonde mirtifforme 13 cm
- boîte métal avec 2 plateaux perforés

Estuche para suturas compuesto de:

- 1 MATHIEU porta-agujas 14 cm
- 1 paquete de seda, estéril
- 6 agujas diferentes para suturas
- 1 cajita perforada para agujas
- 1 MICHEL pinza para agrafes
- 20 MICHEL agrafes, en dispositivo
- 1 mango de bisturi # 4
- 4 hojas diferentes de bisturi
- 1 tijera 13 cm recta ag/ro
- 1 pinza de disección 11,5 cm
- 1 pinza de disección 12 cm 1x2 dientes
- 1 HUNTER pinza para espinas 10,5 cm
- 1 KOCHER pinza hemostática 13 cm, 1x2 dientes
- 1 Sonda miritforme 13 cm
- caja metálica con 2 bandejas perforadas para instrumentos

Set per sutura composto di:

- 1 MATHIEU porthagi 14 cm
- 1 flacone di seta per sutura, sterile
- 6 aghi assortiti per sutura
- 1 astuccio per aghi, perforato
- 1 MICHEL pinza per agrafes
- 20 MICHEL agrafes, con supporto
- 1 manico per bisturi # 4
- 4 lame per bisturi, assortite
- 1 forbice chirurgica, 13 cm retta, ap/sm
- 1 pinza anatomica 11,5 cm
- 1 pinza chirurgica 12 cm 1x2 denti
- 1 HUNTER pinza per scheggie 10,5 cm
- 1 KOCHER pinza emostatica 13 cm, 1x2 denti
- 1 Sonda miritforme 13 cm
- scatola metallica con 2 bacinelle perforate per gli strumenti

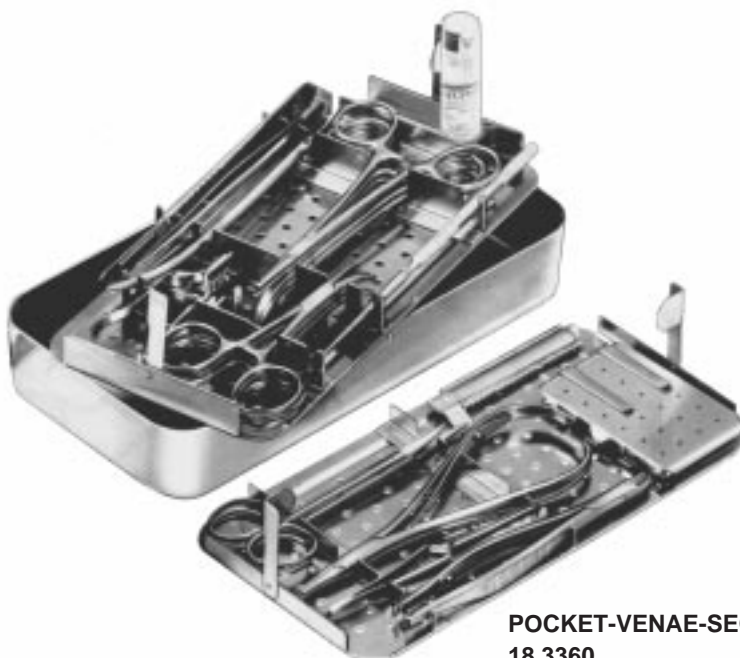

**POCKET-VENAE-SECTIO
18.3360**

Venae-Sectio Besteck bestehend aus:

- 1 Skalpellgriff # 4
- 4 verschiedene Skalpellklingen
- 1 Gefäßschere 11,5 cm gerade mit Knopfende
- 1 Schere 10,5 cm gebogen sp/sp
- 1 SEMKEN anatomische Pinzette 12 cm
- 1 SEMKEN chirurgische Pinzette 12 cm 1x2 Zähne
- 2 MOSQUITO Arterienklemmen 12,5 cm gebogen
- 2 MOSQUITO Arterienklemmen 12,5 cm gerade 1x2 Zähne
- 3 BACKHAUS Tuchklemmen 8 cm
- 1 FINSEN Wundsperrer 7 cm, feststellbar
- 1 DOYEN Hohlsonde 14 cm, gebogen
- 1 MATHIEU Nadelhalter 14 cm
- 3 verschiedene Nähnadeln
- 1 Nadeldose gelocht
- 1 LANGE Wundbrandpinzette 10 cm, selbsthaltend
- 1 MICHEL Wundklammerzängchen
- 20 MICHEL Wundklammern auf Halter
- 1 Unterbindungsnadel fein
- Metalletui mit 2 herausnehmbaren Lagereinsätzen

Venae-Sectio Set consisting of:

- 1 scalpel handle # 4
- 4 different scalpel blades
- 1 vascular scissors 11,5 cm straight, button-end
- 1 scissors 10,5 cm curved, sh/sh
- 1 SEMKEN dressing forceps 12 cm
- 1 SEMKEN dissecting forceps 12 cm, 1x2 teeth
- 2 MOSQUITO artery forceps 12,5 cm, curved
- 2 MOSQUITO artery forceps 12,5 cm, straight, 1x2 teeth
- 3 BACKHAUS towel clamps 8 cm
- 1 FINSEN spreader 7 cm, adjustable
- 1 DOYEN grooved director 14 cm, curved
- 1 MATHIEU needle holder 14 cm
- 3 different surgical needles
- 1 needle case, perforated
- 1 LANGE approximation forceps 10 cm
- 1 MICHEL suture clip forceps
- 20 MICHEL suture clips on clip holder
- 1 ligature needle, delicate
- metal case with 2 perforated storage trays

Trouse pour venae sectio comprenant:

- 1 manche à bistouri # 4
- 4 lames de bistouri, assorties
- 1 ciseaux vasculaires aboutonnés, 11,5 cm droits
- 1 ciseaux 10,5 cm courbes pt/pt
- 1 SEMKEN pince à dissection 12 cm
- 1 SEMKEN pince à dissection 12 cm, 1x2 dents
- 2 MOSQUITO pinces hémostatiques 12,5 cm courbes
- 2 MOSQUITO pinces hémostatiques 12,5 cm droites, 1x2 dents
- 3 BACKHAUS pinces à champs 8 cm
- 1 FINSEN écarteur 7 cm, arrêtant
- 1 DOYEN sonde cannelée 14 cm courbe
- 1 MATHIEU porte-aiguille 14 cm
- 3 aiguilles à suture, assorties
- 1 boîte pour aiguilles, perforée
- 1 LANGE pince pour les bords de la plaie, autostatique
- 1 MICHEL Pince à agrafes
- 20 MICHEL agrafes sur porte-agrales
- 1 aiguille à ligatures, fine
- boîte métal avec 2 plateaux perforés

Estuche para Venaesectio compuesto de:

- 1 mango de bisturi # 4
- 4 hojas diferentes de bisturi
- 1 tijera vascular, recta, abotonada, 11,5 cm
- 1 tijera 10,5 cm curva ag/ro
- 1 SEMKEN pinza de disección, 12 cm
- 1 SEMKEN pinza de disección 12 cm 1x2 dientes
- 2 MOSQUITO pinzas hemostáticas, recta 1x2 dientes
- 3 BACKHAUS pinzas de campo 8 cm
- 1 FINSEN separador, ajustable, 7 cm
- 1 DOYEN sonda acanalada, curva, 14 cm
- 1 MATHIEU porta-agujas 14 cm
- 3 agujas diferentes para suturas
- 1 cajita perforada para agujas
- 1 cajita perforada para agujas
- 1 LANGE pinza aproximadora, autostática, 10 cm
- 1 MICHEL pinza para agrafes
- 20 MICHEL agrafes, en dispositivo
- 1 aguja para ligaduras, fina
- caja metálica con 2 bandejas perforadas para instrumentos

Set per venae sectio composto di:

- 1 manico per bisturi # 4
- 4 lame per bisturi, assortite
- 1 forbice vascolare con punte a bottone 11,5 cm retta
- 1 forbice 10,5 cm, curve ac/ac
- 1 SEMKEN pinza anatomica 12 cm
- 1 SEMKEN pinza chirurgica 12 cm, 1x2 denti
- 2 MOSQUITO pinze emostatiche 12,5 cm curve
- 2 MOSQUITO pinze emostatiche 12,5 cm rette, 1x2 denti
- 3 BACKHAUS pinze fissateli 8 cm
- 1 FINSEN divaricatore 7 cm, regolabile
- 1 DOYEN sonda cannulata 14 cm, curva
- 1 MATHIEU portaghi 14 cm
- 3 aghi assortiti per sutura
- 1 astuccio per aghi, perforato
- 1 LANGE pinza per i bordi della ferita autostatica
- 1 MICHEL pinza per agrafes
- 20 MICHEL agrafes con porte-agrales
- 1 ago per legatura, fino
- contenitore metallico con 2 bacinelle perforate per gli strumenti



REVERDIN
18.4001 – 18.4034



1

18.4001 15 cm
18.4011 19 cm
18.4021 21 cm
18.4031 23 cm



2

18.4002 15 cm
18.4012 19 cm
18.4022 21 cm
18.4032 23 cm



3

18.4003 15 cm
18.4013 19 cm
18.4023 21 cm
18.4033 23 cm



4

18.4004 15 cm
18.4014 19 cm
18.4024 21 cm
18.4034 23 cm

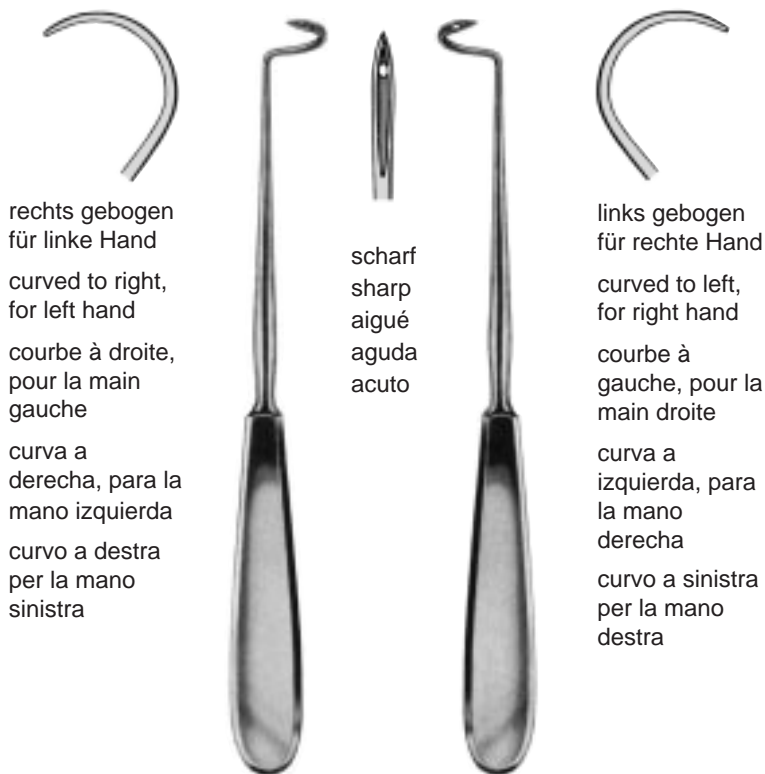

rechts gebogen
für linke Hand

curved to right,
for left hand

courbe à droite,
pour la main
gauche

curva a
derecha, para la
mano izquierda

curvo a destra
per la mano
sinistra

scharf
sharp
aigué
aguda
acuto

links gebogen
für rechte Hand

curved to left,
for right hand

courbe à
gauche, pour la
main droite

curva a
izquierda, para
la mano
derecha

curvo a sinistra
per la mano
destra

DESCHAMPS

18.4100	21 cm	18.4101
18.4104	24 cm	18.4105
18.4108	27 cm	18.4109

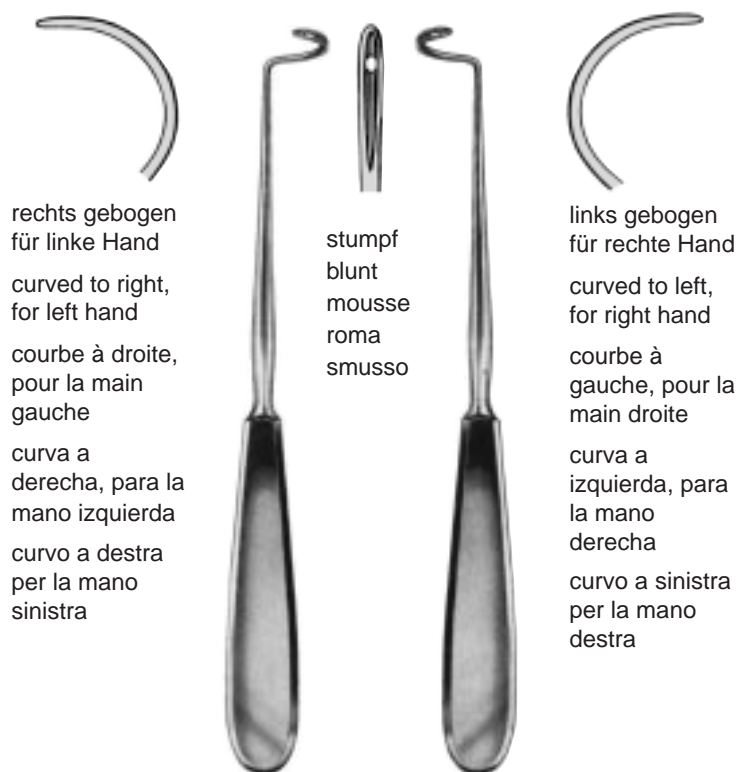

rechts gebogen
für linke Hand

curved to right,
for left hand

courbe à droite,
pour la main
gauche

curva a
derecha, para la
mano izquierda

curvo a destra
per la mano
sinistra

stumpf
blunt
mousse
roma
smusso

links gebogen
für rechte Hand

curved to left,
for right hand

courbe à
gauche, pour la
main droite

curva a
izquierda, para
la mano
derecha

curvo a sinistra
per la mano
destra

DESCHAMPS

18.4102	21 cm	18.4103
18.4106	24 cm	18.4107
18.4110	27 cm	18.4111

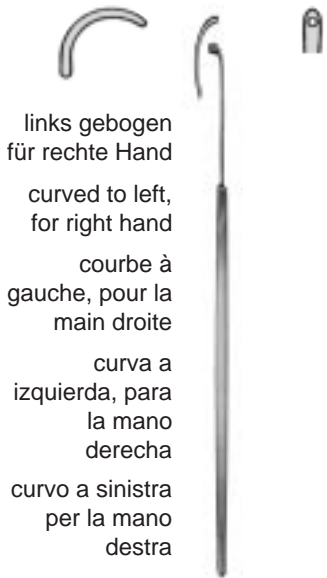

links gebogen
für rechte Hand
curved to left,
for right hand
courbe à
gauche, pour la
main droite
curva a
izquierda, para
la mano
derecha
curvo a sinistra
per la mano
destra

KRONECKER
18.4130 13 cm



rechts gebogen
für linke Hand
curved to right,
for left hand
courbe à droite,
pour la main
gauche
curva a
derecha, para la
mano izquierda
curvo a destra
per la mano
sinistra

KRONECKER
18.4131 13 cm



links gebogen
für rechte Hand
curved to left,
for right hand
courbe à
gauche, pour la
main droite
curva a
izquierda, para
la mano
derecha
curvo a sinistra
per la mano
destra

KRONECKER
18.4132 13 cm

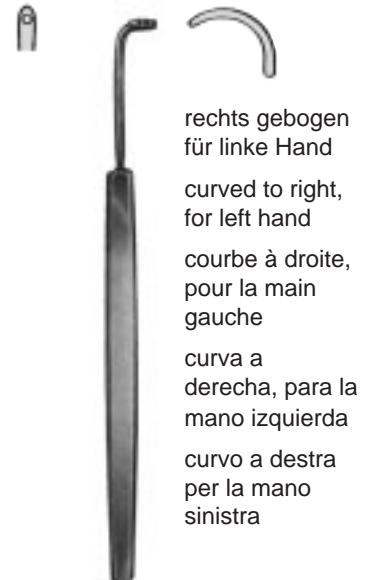

rechts gebogen
für linke Hand
curved to right,
for left hand
courbe à droite,
pour la main
gauche
curva a
derecha, para la
mano izquierda
curvo a destra
per la mano
sinistra

KRONECKER
18.4133 13 cm



biegsam
malleable
malléable
maleable
malleabili

LIGATURE
18.4140 19 cm



biegsam
malleable
malléable
maleable
malleabili

COOPER
18.4150 20 cm

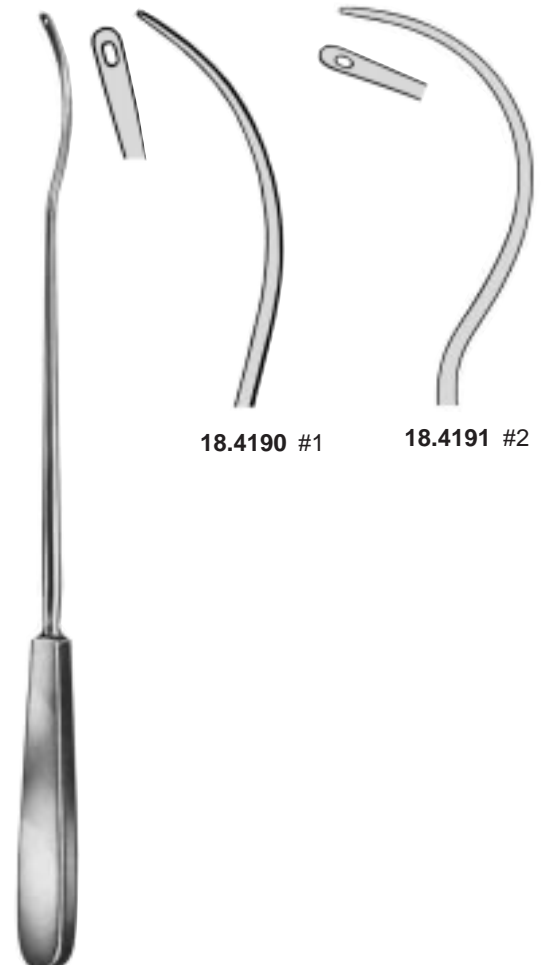

18.4190 #1

18.4191 #2

BRUNNER
30 cm



PAYR
18.4211 20 cm



PAYR
18.4212 22 cm



PAYR
18.4213 22 cm



KOENIG

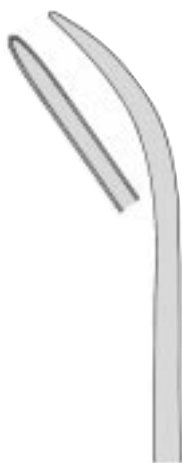

18.4241
19 cm / 3 mm



18.4243
19 cm / 5 mm



18.4245
20 cm / 7 mm



18.4261
1

18.4263
2

BRUNNER
30 cm

Fadengabel
Ligature fork
Pousse-fil
Horquilla para ligaduras
Forchetta da sutura



BRUNNER-FERROZELL
18.4301 18 cm
18.4303 27 cm

FERROZELL
18.4340 19 cm
gerade/straight
droite/rectas/retto
18.4341 19 cm
gebogen/curved
courbe/curvas/curvo



LIGATURE
18.4250 23 cm



MOD. WIEN
18.4255 23,5 cm

Fadenfänger
Suture catcher
Porte-ligature
Porta-ligadura
Portalegature

SONDEN, ASPIRATION, PUNKTION, INJEKTION
PROBES, ASPIRATION, PUNCTURE, INJECTION
STYLETS, ASPIRATION, PUNCTURE, INJECTION
ESTILETES, ASPIRACION, PUNCIÓN, INYECCION
SPECILLI, ASPIRAZIONE, PUNTURA, INIEZIONE

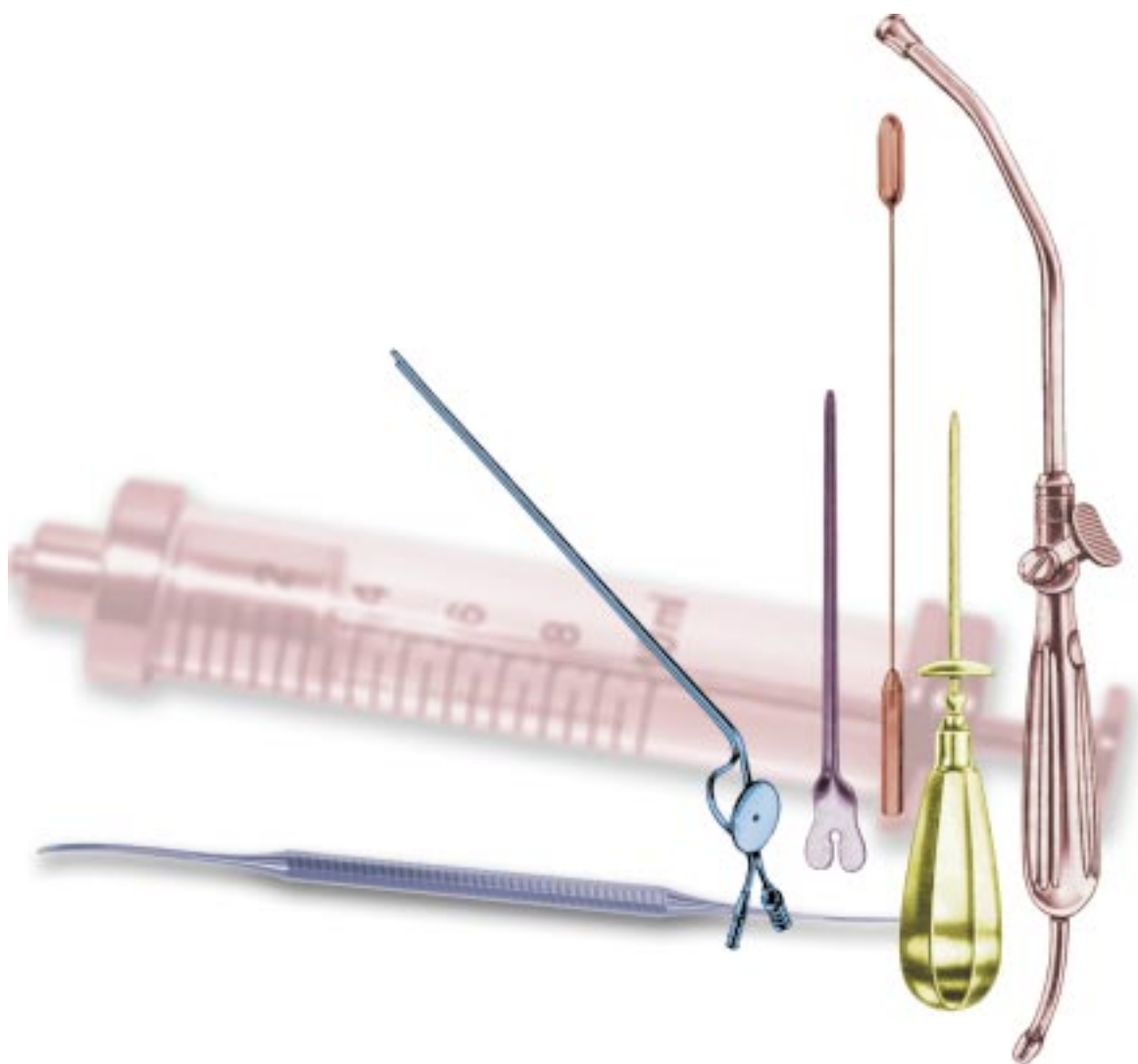

Tränenkanalsonden und -dilatoren
 Lacrimal Probes and Dilators
 Stylets et dilateurs pour le canal lacrimal
 Sondas exploradoras y dilatadoras para canal lacrimal
 Sonde esploratrici e dilatatori per canale lacrimale



		\varnothing / mm
30.1700	#00/0 NS	0,7 / 0,8
30.1701	# 0/1 NS	0,8 / 0,9
30.1702	# 1/2 NS	0,9 / 1,1
30.1703	# 2/3 NS	1,1 / 1,3
30.1704	# 3/4 NS	1,3 / 1,4
30.1705	# 4/5 NS	1,4 / 1,5
30.1706	# 5/6 NS	1,5 / 1,6
30.1707	# 6/7 NS	1,6 / 1,8
30.1708	# 7/8 NS	1,8 / 1,9

Neusilber
 German silver
 Argent blanc
 plata alemana
 argentone

BOWMAN



		\varnothing / mm
30.1738	#0000/000 NS	0,5 / 0,6
30.1740	# 00/0 NS	0,7 / 0,8
30.1741	# 0/1 NS	0,8 / 0,9
30.1742	# 1/2 NS	0,9 / 1,1
30.1743	# 2/3 NS	1,1 / 1,3
30.1744	# 3/4 NS	1,3 / 1,4
30.1745	# 4/5 NS	1,4 / 1,5
30.1746	# 5/6 NS	1,5 / 1,6
30.1747	# 6/7 NS	1,6 / 1,8
30.1748	# 7/8 NS	1,8 / 1,9

Neusilber
 German silver
 Argent blanc
 plata alemana
 argentone

BOWMAN

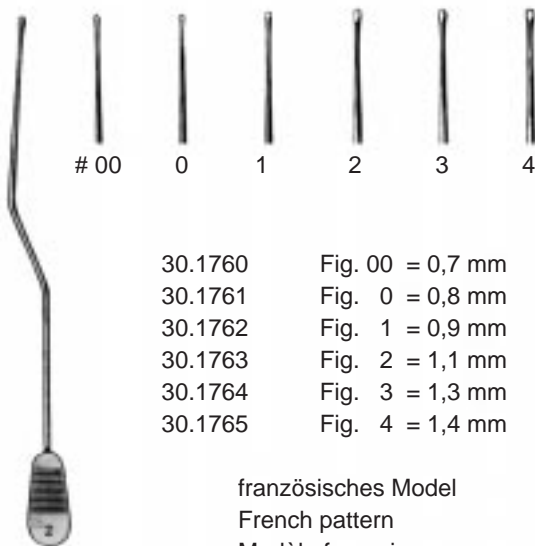

30.1760	Fig. 00 = 0,7 mm
30.1761	Fig. 0 = 0,8 mm
30.1762	Fig. 1 = 0,9 mm
30.1763	Fig. 2 = 1,1 mm
30.1764	Fig. 3 = 1,3 mm
30.1765	Fig. 4 = 1,4 mm

12,5 cm

französisches Model
 French pattern
 Modèle française
 Modelo francés
 Modello francese



WILDER
30.1601
11 cm #1



WILDER
30.1602
11 cm #2



WILDER
30.1603
11 cm #3



INFANT
30.1605
8 cm



MULDOON
30.1606
12,5 cm



CASTROVIEJO
30.1620
12 cm



WORST
30.1630
15 cm

"Pigtail" Sonde mit Loch
"Pigtail" sound with eye
"Pigtail" sonde avec oeillet
"Pigtail" sonda con ojo
"Pigtail" sonda con occhiello

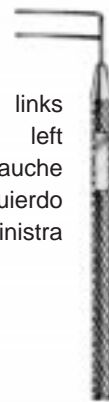

links
left
à gauche
izquierdo
sinistra

HARMS
30.1640
5 cm

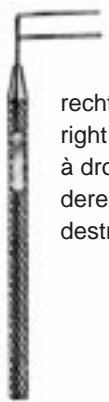

rechts
right
à droite
derecho
destra

HARMS
30.1642
5 cm

19.0101

13,0 cm /Ø 1,0 mm

19.0102

14,5 cm /Ø 1,0 mm

19.0103

16,0 cm /Ø 1,0 mm

19.0104

18,0 cm /Ø 1,0 mm

19.0105

20,0 cm /Ø 1,0 mm

19.0106

25,0 cm /Ø 1,0 mm

19.0109

10,5 cm /Ø 1,5 mm

19.0110

11,5 cm /Ø 1,5 mm

19.0111

13,0 cm /Ø 1,5 mm

19.0112

14,5 cm /Ø 1,5 mm

19.0113

16,0 cm /Ø 1,5 mm

19.0114

18,0 cm /Ø 1,5 mm

19.0115

20,0 cm /Ø 1,5 mm

19.0116

25,0 cm /Ø 1,5 mm

19.0117

30,0 cm /Ø 1,5 mm

19.0119

10,5 cm /Ø 2,0 mm

19.0120

11,5 cm /Ø 2,0 mm

19.0121

13,0 cm /Ø 2,0 mm

19.0122

14,5 cm /Ø 2,0 mm

19.0123

16,0 cm /Ø 2,0 mm

19.0124

18,0 cm /Ø 2,0 mm

19.0125

20,0 cm /Ø 2,0 mm

19.0126

25,0 cm /Ø 2,0 mm

19.0127

30,0 cm /Ø 2,0 mm

Ø 4,0 mm

19.0128

40 cm

19.0200

11,5 cm /Ø 2,0 mm

19.0201

13,0 cm /Ø 2,0 mm

19.0202

14,5 cm /Ø 2,0 mm

19.0203

16,0 cm /Ø 2,0 mm

19.0204

18,0 cm /Ø 2,0 mm

19.0205

20,0 cm /Ø 2,0 mm

19.0206

25,0 cm /Ø 2,0 mm

19.0207

30,0 cm /Ø 2,0 mm

Silber
Silver
Argent
Plata
Argento

19.0210

11,5 cm /Ø 2,0 mm

19.0211

13,0 cm /Ø 2,0 mm

19.0212

14,5 cm /Ø 2,0 mm

19.0213

16,0 cm /Ø 2,0 mm

19.0214

18,0 cm /Ø 2,0 mm

19.0215

20,0 cm /Ø 2,0 mm

19.0216

25,0 cm /Ø 2,0 mm

mit Öhr / with eye / avec oeillet / con ojo / con occhello



19.0302
 14,5 cm
19.0303
 16 cm

MYRTLE



19.0320
 11,5 cm
19.0321
 13 cm
19.0322
 14,5 cm
19.0323
 16 cm
19.0324
 18 cm
19.0325
 20 cm



19.0332
 14.5 cm

DOYEN



19.0351
 11,5 cm
19.0352
 13 cm
19.0353
 14,5 cm
19.0354
 16 cm
19.0355
 18 cm
19.0356
 20 cm



NELATON
 19.0363 16 cm



LOCKHART-MUMMERY
 16,5 cm



19.0371
 # 1



19.0372
 # 2



19.0373
 # 3



19.0374
 # 4

Ohr- und Sinussonden
Ear- and Sinus Probes
Sondes auriculaires et nasales
Sondas auriculares y para seno
Sonde auricolari e per sino



Silber
Silver
Argent
Plata
Argento

STACKE
19.0249
11 cm /Ø 1mm



FISH
19.0250
14 cm /Ø 2 mm
19.0252
18 cm /Ø 2 mm



RITTER-HALLE
33.1120 16 cm /Ø 2,5 mm
33.1122 16 cm /Ø 3,0 mm
33.1124 16 cm /Ø 4,0 mm
33.1125 16 cm /Ø 5,0 mm



GARRETT
40.2800 -
40.2828

40.2810
14 cm /1,0-5,0 mm
Satz /Set/Jeu/Juego/Set
40.2800-40.2808

40.2830
22 cm /1,0-5,0 mm
Satz /Set/Jeu/Juego/Set
40.2820-40.2828



DEBAKEY
40.3000 -
40.3041

40.3012
19 cm /0,5-0,9 mm
Satz /Set/Jeu/Juego/Set
40.3000-40.3011

40.3042
35 cm /0,5-0,9 mm
Satz /Set/Jeu/Juego/Set
40.3030-40.3041

GARRETT 14 cm
22 cm

DEBAKEY 19 cm
35 cm



0,5 mm Ø



1,0 mm Ø

40.2800
40.2820



1,5 mm Ø

40.2801
40.2821



2,0 mm Ø

40.2802
40.2822



2,5 mm Ø

40.2803
40.2823



3,0 mm Ø

40.2804
40.2824



3,5 mm Ø

40.2805
40.2825



4,0 mm Ø

40.2806
40.2826

GARRETT 14 cm
22 cm

DEBAKEY 19 cm
35 cm



4,5 mm Ø

40.2807
40.2827



5,0 mm Ø

40.2808
40.2828



7,0 mm Ø

40.3009
40.3010



9,0 mm Ø

40.3011
40.3041

GARRETT 14 cm
22 cm

DEBAKEY 19 cm
35 cm

40.3008
40.3038

40.3009
40.3039

40.3010
40.3040

40.3011
40.3041



PRATT
21,5 cm



48.1301
#1



48.1302
#2



48.1303
#3

Cystikus-Häkchen (Fistelsonden)
Crypt hooks (Fistula probes)
Crochets à crypte (Sondes pour fistules)
Ganchos para cripta (Sondas para fistula)
Ganci a cripta (Sonde per fistola)



BUIE
48.1310
16 cm



MIXTER
50.0010
 30 cm



DESJARDINS
 30 cm
 federnd
 elastic
 élastique
 elásticos
 elastico

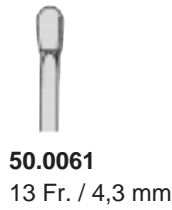

50.0061
 13 Fr. / 4,3 mm



50.0062
 18 Fr. / 6,0 mm

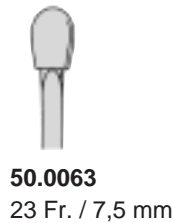

50.0063
 23 Fr. / 7,5 mm

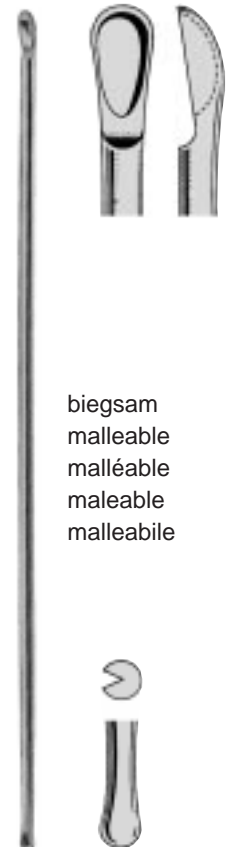

biegsam
 malleable
 malléable
 maleable
 malleabile

MOYNIHAN
50.0140
 34 cm

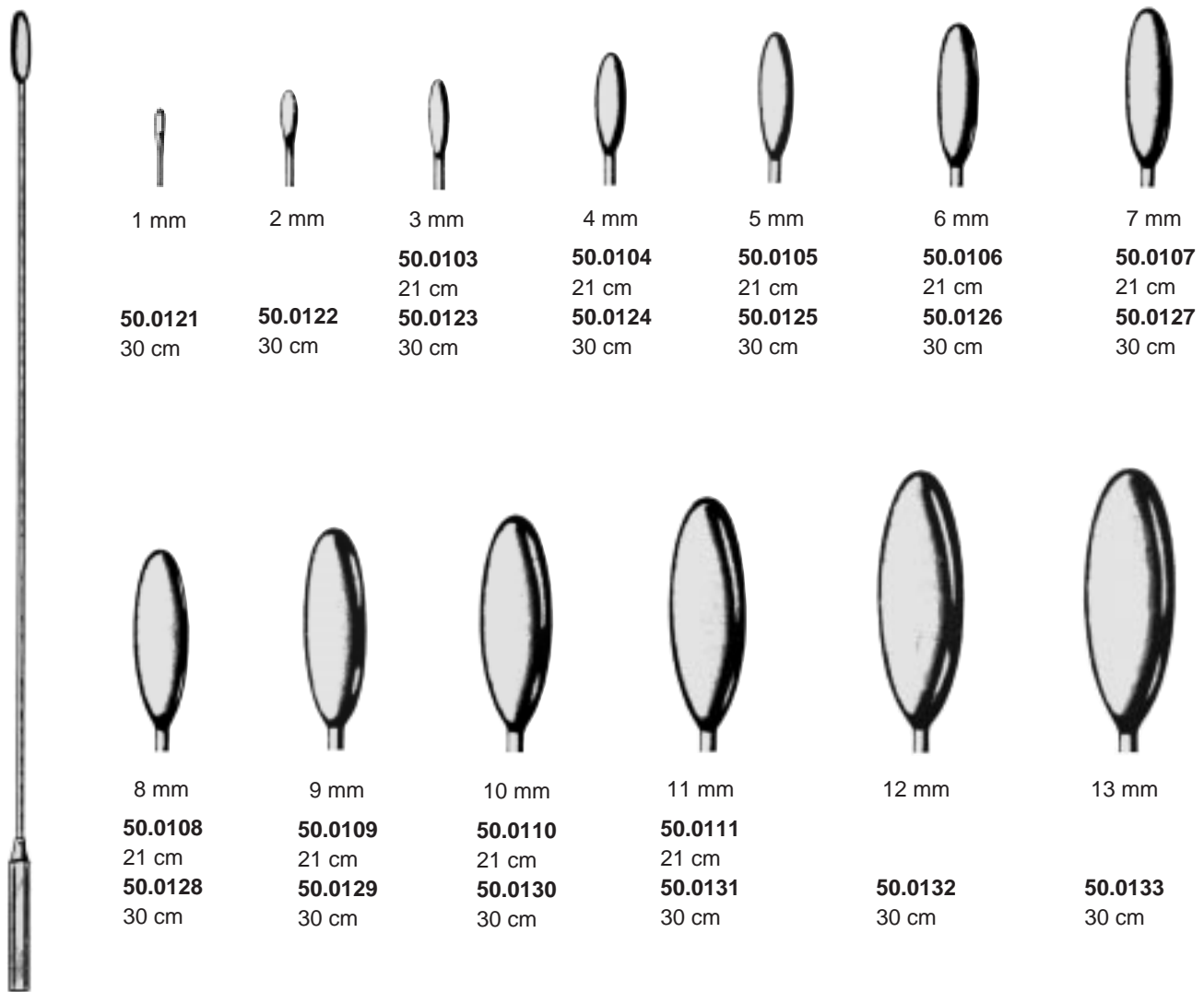

BAKES

Schaft biegsam
 malleable shaft
 tige malléable
 vástago maleable
 gambo flessibile

50.0100

Satz / set / jeu / juego / set
 50.0103-50.0111
 21 cm 3 - 11 mm

50.0120

Satz / set / jeu / juego / set
 50.0121-50.0131
 30 cm 1 - 13 mm

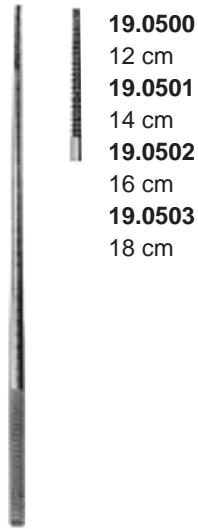

19.0500
12 cm
19.0501
14 cm
19.0502
16 cm
19.0503
18 cm

FARRELL



19.0510
12 cm
19.0511
14 cm
19.0512
16 cm
19.0513
18 cm

FARRELL



19.0520
12 cm
19.0521
14 cm
19.0522
16 cm
19.0523
18 cm



19.0530
12 cm
19.0531
14 cm
19.0532
16 cm
19.0533
18 cm



48.1602
38 cm



48.1603
38 cm



UCKERMANN
19.0540 15 cm



JOBSON-HORNE
19.0550 14,5 cm
19.0553 18 cm

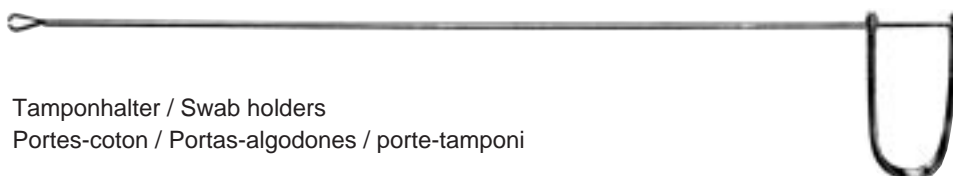

Tamponhalter / Swab holders
Portes-coton / Portas-algodones / porte-tamponi

27.0003	3 Fr. 14,5 cm
27.0004	4 Fr. 14,5 cm
27.0005	5 Fr. 14,5 cm
27.0006	6 Fr. 14,5 cm
27.0007	7 Fr. 14,5 cm
27.0008	8 Fr. 14,5 cm
27.0009	9 Fr. 14,5 cm
27.0010	10 Fr. 14,5 cm
27.0011	11 Fr. 14,5 cm
27.0012	12 Fr. 14,5 cm
27.0013	3 Fr. 16,0 cm
27.0014	4 Fr. 16,0 cm
27.0015	5 Fr. 16,0 cm
27.0016	6 Fr. 16,0 cm
27.0017	7 Fr. 16,0 cm
27.0018	8 Fr. 16,0 cm
27.0019	9 Fr. 16,0 cm
27.0020	10 Fr. 16,0 cm
27.0021	11 Fr. 16,0 cm
27.0022	12 Fr. 16,0 cm
27.0023	3 Fr. 18,0 cm
27.0024	4 Fr. 18,0 cm
27.0025	5 Fr. 18,0 cm
27.0026	6 Fr. 18,0 cm
27.0027	7 Fr. 18,0 cm
27.0028	8 Fr. 18,0 cm
27.0029	9 Fr. 18,0 cm
27.0030	10 Fr. 18,0 cm
27.0031	11 Fr. 18,0 cm
27.0032	12 Fr. 18,0 cm
27.0033	3 Fr. 21,5 cm
27.0034	4 Fr. 21,5 cm
27.0035	5 Fr. 21,5 cm
27.0036	6 Fr. 21,5 cm
27.0037	7 Fr. 21,5 cm
27.0038	8 Fr. 21,5 cm
27.0039	9 Fr. 21,5 cm
27.0040	10 Fr. 21,5 cm
27.0041	11 Fr. 21,5 cm
27.0042	12 Fr. 21,5 cm

biegsam / malleable / maléable /
maleable / malleablile



FUKUSHIMA
27.0003 - 27.0042



ADSON
27.0056
 21 cm / 4 mm
 Charr. / Fr. 12



ADSON
27.0057
 21 cm / 4 mm
 Charr. / Fr. 12



FRAZIER
27.0066 10 cm / 2,0 mm
27.0067 10 cm / 2,5 mm
27.0068 10 cm / 3,0 mm



27.0070
 1,8 + 1,8 mm



27.0071
 2,5 + 2,0 mm

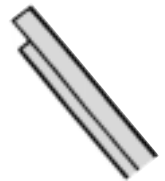

27.0072
 3,0 + 2,0 mm



HOUSE
 18 cm



HOUSE
27.0073 9 cm / 0,9 + 0,7 mm
27.0074 9 cm / 1,2 + 0,9 mm
27.0075 9 cm / 1,5 + 1,2 mm



FISCH
27.0076 9 cm / 1,8 + 1,8 mm
27.0077 9 cm / 2,5 + 2,0 mm
27.0078 9 cm / 3,0 + 2,0 mm
27.0079 9 cm / 4,5 + 2,0 mm



27.0094
 Ø 0,4 mm



27.0096
 Ø 0,6 mm



27.0098
 Ø 0,8 mm

WULLSTEIN

27.0090 Mikro-Absaugrohr komplett, bestehend aus:
 27.0091 Saugerhandgriff 14 cm
 27.0094 Mikro-Saugkanüle 0,4 mm Ø
 27.0096 Mikro-Saugkanüle 0,6 mm Ø
 27.0098 Mikro-Saugkanüle 0,8 mm Ø

Micro-canule aspiratrice complète, comprenant:
 27.0091 Manche pour canule d'aspiration
 27.0094 Micro Canule aspiratrice 0,4 mm Ø
 27.0096 Micro Canule aspiratrice 0,6 mm Ø
 27.0098 Micro Canule aspiratrice 0,8 mm Ø

Micro-suction tube complete, consisting of:
 27.0091 Suction handle
 27.0094 Micro Suction Canula 0,4 mm Ø
 27.0096 Micro Suction Canula 0,6 mm Ø
 27.0098 Micro Suction Canula 0,8 mm Ø

Micro-Tubo de aspiración completo, compuesto de:
 27.0091 Mango para cánula de aspiración
 27.0094 Micro Canula de aspiración 0,4 mm Ø
 27.0096 Micro Canula de aspiración 0,6 mm Ø
 27.0098 Micro Canula de aspiración 0,8 mm Ø

Micro-Tubo completo, composto di:
 27.0091 Manico d'aspirazione
 27.0094 Tubo aspirazione 0,4 mm Ø
 27.0096 Tubo aspirazione 0,6 mm Ø
 27.0098 Tubo aspirazione 0,8 mm Ø

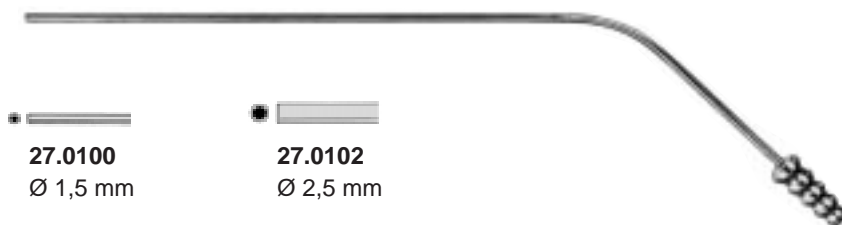

27.0100
 Ø 1,5 mm

27.0102
 Ø 2,5 mm

27.0101
 Ø 2,0 mm

27.0103
 Ø 3,5 mm

YASARGILL
 150 mm



FRAZIER

27.0170	6 Charr. / Fr.
27.0171	7 Charr. / Fr.
27.0172	8 Charr. / Fr.
27.0173	9 Charr. / Fr.
27.0174	10 Charr. / Fr.
27.0175	11 Charr. / Fr.
27.0176	12 Charr. / Fr.
27.0176E	12 Charr. / Fr.
27.0179	15 Charr. / Fr.

E = isoliert / insulated / isolé / con aislamiento / isolare



FERGUSON

27.0180	6 Charr. / Fr.
27.0181	7 Charr. / Fr.
27.0181E	7 Charr. / Fr.
27.0182	8 Charr. / Fr.
27.0183	9 Charr. / Fr.
27.0183E	9 Charr. / Fr.
27.0184	10 Charr. / Fr.
27.0185	11 Charr. / Fr.
27.0185E	11 Charr. / Fr.
27.0186	12 Charr. / Fr.
27.0187	15 Charr. / Fr.

E = isoliert / insulated / isolé / con aislamiento / isolare



FRAZIER

27.0190	6 Charr. / Fr.
27.0191	7 Charr. / Fr.
27.0192	8 Charr. / Fr.
27.0193	9 Charr. / Fr.
27.0194	10 Charr. / Fr.
27.0195	11 Charr. / Fr.
27.0196	12 Charr. / Fr.

27.0199

Reinigungsdraht für FRAZIER/FERGUSON
Replacement Stylet for FRAZIER/FERGUSON
Tige de rechange pour FRAZIER/FERGUSON
Alambre de recambio para FRAZIER/FERGUSON
Filo-puliere per FRAZIER/FERGUSON

Griff mit LUER-Konus, passend für
 WULLSTEIN Spül- und Saugrohre

Handle with LUER-cone, for
 WULLSTEIN irrigating- and suction tubes

Manche à cône LUER, pour tubes
 aspirateurs/irrigateurs de WULLSTEIN

Mango con cono LUER, para tubos de
 aspiracion y lavado según WULLSTEIN

Manico con cono LUER, per cannule
 per aspirazione e lavaggio di WULLSTEIN



WULLSTEIN
32.1160



WULLSTEIN
32.1161
 16 cm /1,5 mm Ø
32.1162
 16 cm /2,0 mm Ø



WULLSTEIN
32.1163
 16 cm /7,5 mm Ø
 konisch
 conical
 conique
 cónico
 conico



PLESTER
32.1166
 19,5 cm 1,5 mm Ø
32.1167
 19,5 cm 2,0 mm Ø
32.1168
 19,5 cm 2,5 mm Ø
32.1169
 19,5 cm 3,0 mm Ø



ROSEN
32.1170
 80 x 0,7 mm Ø
32.1172
 80 x 0,9 mm Ø
32.1174
 80 x 1,2 mm Ø



ROSEN
32.1177 65 x 0,5 mm Ø
32.1171 65 x 0,7 mm Ø
32.1173 65 x 0,9 mm Ø
32.1175 65 x 1,2 mm Ø
32.1178 65 x 1,5 mm Ø
32.1179 65 x 2,0 mm Ø



ZOELLNER
32.1181
 Saugkanüle alleine
 Aspirating tube only
 Tube à aspiration seul
 Tubo aspirador suelto
 canula aspiratrice sola

ZOELLNER
32.1180
 Absaugröhrchen mit Griffplatte, komplett
 mit 1 Kanüle 0,7 mm Ø
 Suction tube with finger plate, complete
 with 1 slip-on cannula 0,7 mm Ø
 Tube aspirateur à appui-doigt, complet
 avec 1 canule démontable 0,7 mm Ø
 Tubito de succión, con mango plano,
 completo con 1 cánula desmontable 0,7 mm Ø
 Cannula per aspirazione con appoggiadita, completo
 con 1 cannula applicabile 0,7 mm Ø

Aufsetzbare Mikrokanülen
 Micro Cannulae
 Microcannules démontables
 Microcánulas desmontable
 Microcannula applicabile

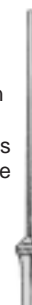

ZOELLNER
32.1185 30 mm, 0,5 mm Ø
32.1187 30 mm, 0,7 mm Ø
32.1188 30 mm, 0,9 mm Ø
32.1189 30 mm, 1,2 mm Ø

Spülkatheter für Nase und Kieferhöhle
 Irrigating Tubes for Nose and maxillary cavity
 Sondes à lavage pour nez et sinus maxillaire
 Sondas irrigadoras para nariz y el seno maxilar
 Cannuas irrigatrice per naso e seno mascellare



HARTMAN
32.1190
 für rechtes Ohr
 for right ear
 pour oreille droite
 para oido recto
 per orecchio destro

HARTMANN
32.1191
 für linkes Ohr
 for left ear
 pour oreille gauche
 para oido sinistro
 per orecchio sinistro



32.1193
 11 cm / 3 mm
32.1194
 11 cm / 3,5 mm

32.1195
 3 cm / 4 mm

konisch / conical / conique / cónico / conico



BARON
33.1130 7,5 cm charr. 3
33.1131 7,5 cm charr. 5
33.1132 7,5 cm charr. 7
33.1135 10,0 cm charr. 3
33.1136 10,0 cm charr. 5
33.1137 10,0 cm charr. 7

EICKEN-KILLIAN
33.1154
 15cm, 2,5 mm Ø
33.1155
 15cm, 3,0 mm Ø

GUILLEN
33.1156
 19 cm

33.1170
 16 cm 5 mm Ø

KILLIAN
33.1180
 17cm 1,5mm Ø



33.1204 2,5mm Ø
33.1205 3,5mm Ø

33.1214 2,5mm Ø
33.1215 3,5mm Ø

SIEBENMANN
 13,5 cm



Mandrin
 stylet
 doigt
 estilete
 stiletto

MAGILL
 24,5 cm
33.1220 3,0mm Ø
33.1221 3,5mm Ø
33.1222 4,0mm Ø
33.1223 Reinigungsdraht
 Cleaningwire
 Tige à nettoyage
 Alambre-limpieza
 Filo-puliere



GORNEY
33.1890
 18 cm
 Saugdissektor
 Suction Dissector
 Dissecteur à aspiration
 Disecador para aspiración
 Dissetore a aspirazione



SCHMID
 15 cm

40.3103
 3,0 mm Ø



40.3104
 4,0 mm Ø



40.3105
 5,0 mm Ø



40.3106
 6,0 mm Ø



Gefäß-Spülkanülen
 Vessel Irrigating Cannulas
 Canules pour irrigation vasculaire
 Cánulas para irrigación vascular
 Cannule per irrigazione vascolare



ANDREW-PYNCHON
19.0700 24 cm



COUPLAND
33.1160 26 cm

mit 2 Ansätzen
with 2 tips
avec 2 embouts
con 2 puntas
con 2 punte
1,5 / 2,0 mm Ø



YANKAUER
19.0710 27 cm
19.0711 36 cm
19.0712 40 cm
19.0713 46 cm
Ø 10 mm
komplett
complete
complet
completo

19.0718



mit Absperrventil u. abschraubbarem Rohr
with stopcock and removeable tube
avec robinet et canule demontable
con llave y tubo desmontable
con interruttore e tubo svitabile

YANKAUER
19.0715 33 cm
Ø 10 mm



POOLE
19.0726
20 cm, Ø 5,5mm



POOLE
19.0727
20 cm, Ø 5,5mm



POOLE
19.0720
23 cm / 30 Fr.



POOLE
19.0721 20 cm / 23 Fr.
19.0722 30 cm / 18 Fr.
19.0723 36 cm
19.0724 46 cm
Ø 8 mm



WIJNEN
19.0738
33 cm Ø 12 mm



DEBAKEY
19.0746
31 cm Ø 9 mm



DEBAKEY
19.0747
16 cm Ø 5 mm
19.0748
27 cm Ø 5 mm

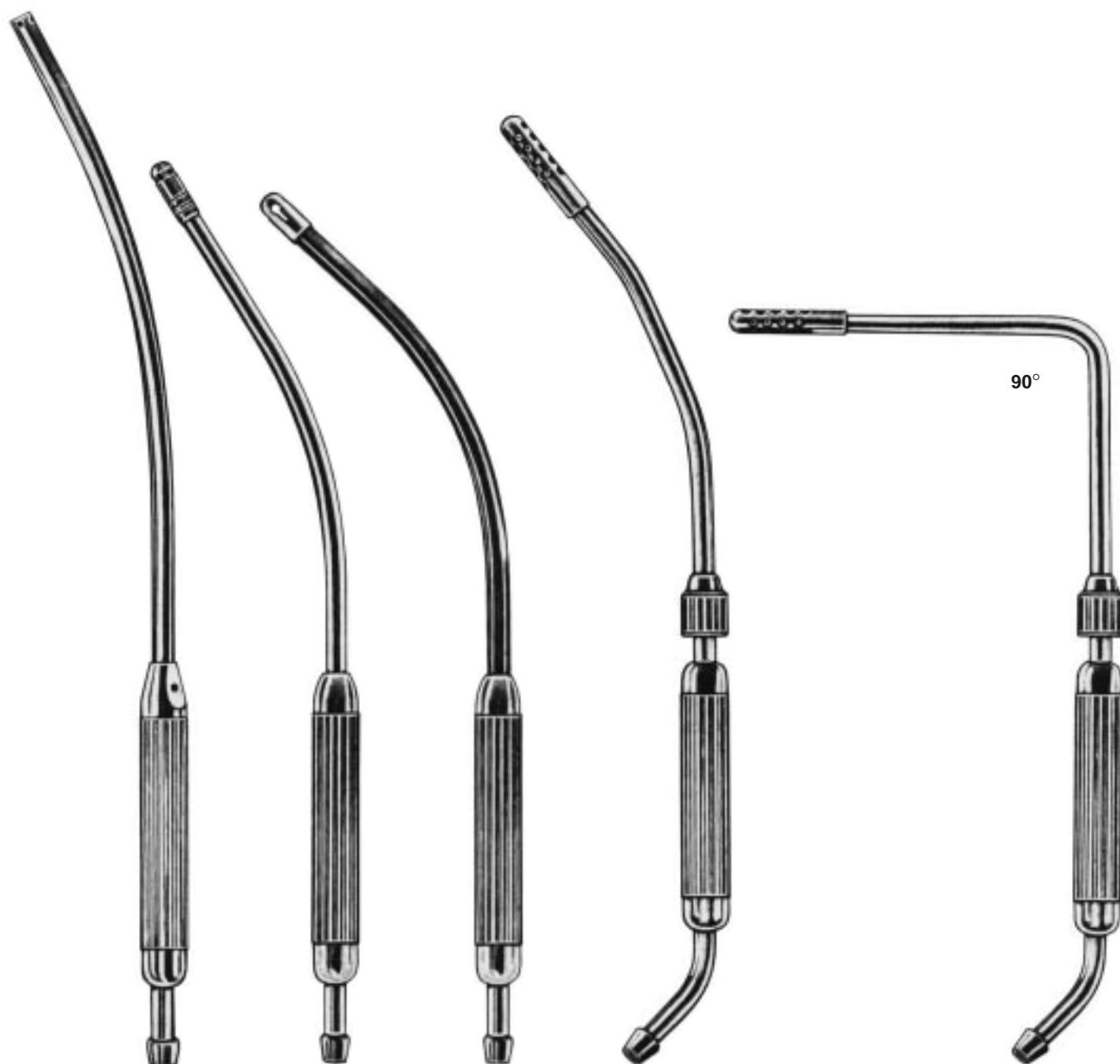

COOLEY
19.0750
36 cm
Ø 8 mm #1

COOLEY
19.0751
31 cm
Ø 7 mm #2

COOLEY
19.0752
31 cm
Ø 10 mm #3

COOLEY
19.0753
35 cm
Ø 8 mm #4

COOLEY
19.0754
25 cm
Ø 9 mm #5



REDON

20 cm

- 19.0760** 8 Charr
- 19.0761** 10 Charr
- 19.0762** 12 Charr
- 19.0763** 14 Charr
- 19.0764** 16 Charr
- 19.0765** 18 Charr



REDON

20 cm

- 19.0770** 8 Charr
- 19.0771** 10 Charr
- 19.0772** 12 Charr
- 19.0773** 14 Charr
- 19.0774** 16 Charr
- 19.0775** 18 Charr



19.1010
mit 4 Trokaransätzen
with 4 trocar tips
avec 4 embouts de trocars
con 4 puntas de trócar
con 4 punte di trequarti
1,7, 3,0, 4,5 + 6,0 mm Ø

UNIVERSAL
14 cm



Ø
19.1020 3,0 mm
19.1021 3,5 mm
19.1022 4,0 mm
19.1023 4,5 mm
19.1024 5,0 mm
19.1025 5,5 mm
19.1026 6,0 mm

UNIVERSAL



Ø
19.1030 3,0 mm
19.1031 3,5 mm
19.1032 4,0 mm
19.1033 4,5 mm
19.1034 5,0 mm
19.1035 5,5 mm
19.1036 6,0 mm

mit Absperrventil
with stopcock
avec robinet
con interruptor
con interruttore

UNIVERSAL



LICHTWITZ
19.1050
19 cm Ø1,75 mm



OCHSNER
15 cm

Ø
19.1199 9 Fr. / 3,0 mm
19.1200 10 Fr. / 3,5 mm
19.1201 12 Fr. / 4,0 mm
19.1202 14 Fr. / 4,5 mm
19.1204 16 Fr. / 5,5 mm
19.1205 18 Fr. / 6,0 mm
19.1206 20 Fr. / 6,5 mm



Ø
19.1210 25 Fr./ 8 mm
19.1211 30 Fr./10 mm
19.1212 33 Fr./11 mm
19.1213 35 Fr./12 mm

NELSON
21 cm



LANDAU
19.1220 2 mm Ø
19 cm



COAKLEY
19.1300 2,25 mm Ø
16 cm



PIERCE
19.1310 3,0 mm Ø
19.1311 4,0 mm Ø
19.1312 5,0 mm Ø
15 cm



KRAUSE
19.1320
16 cm 5,5 mm Ø



DOUGLAS
33.1100
3,0 mm Ø



LERMOYEZ
33.1102 2,0 mm Ø
33.1103 2,5 mm Ø
33.1104 3,0 mm Ø



VAN ALYEA
33.1110
11,5 cm 1,75 mm Ø



NABATOFF

19.2000

Krampfaderbesteck komplett
 Varicose Vein Probe Set complete
 Trousse à varices complète
 Juego para varices completo
 Set di sondi per varici completo

19.2001

Metall-Etui alleine
 Metal case only
 Boîte métallique seule
 Estuche de metal solo
 Astuccio metallico solo

Ersatzteile / spare parts / pieces de rechange /
 piezas de repuesto / pezzi di ricambio

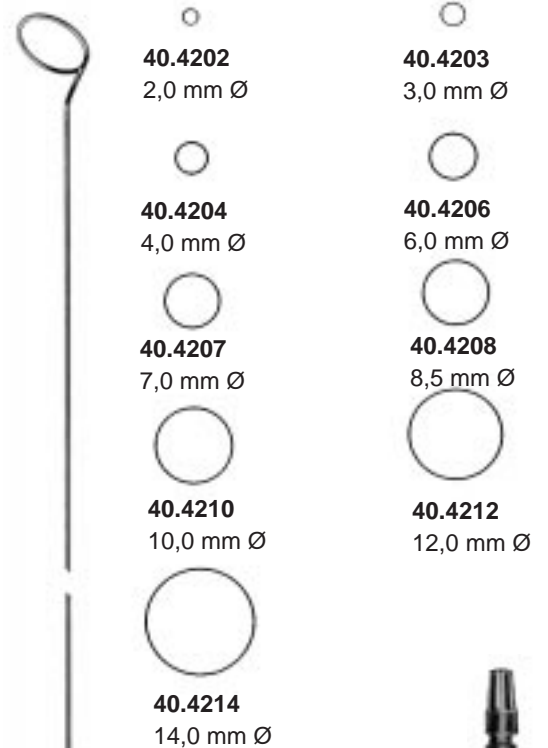
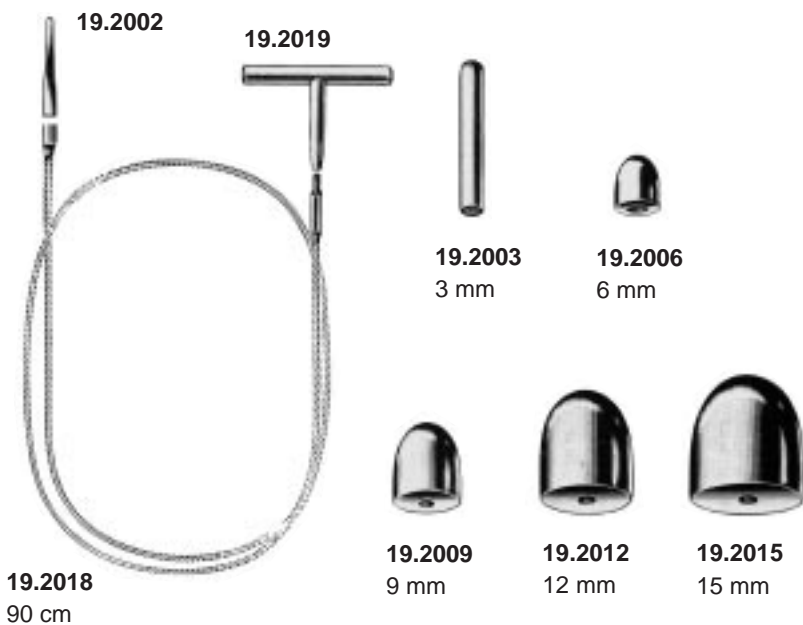

VOLLMAR

50 cm
 Ringstripper
 Ring Strippers
 Strippers à anelli
 Fleboextractor
 Stripper anello

40.4219

GRIFFF für Ringstripper
 Handle of Ring Strippers
 Manche pour Strippers à anneau
 Mango para Fleboextractores
 Manico per stripper
 40.4202 - 40.4214





VARADY
19.2101
 18 cm

Phlebodissektor
 Phlebodissector
 Dissecteur pour phlébite
 Flebodisecador
 Flebo-dissettore

VARADY
19.2102
 18 cm

Phlebextraktor
 Phleboextractor
 Extracteur pour phlébite
 Flebextractor
 Flebo-estrattore

VARADY
19.2103
 18 cm

VARADY
19.2104
 18 cm

Mikro-Dissektor
 Micro Dissector
 Micro dissecteur
 Micro disecador
 Micro-dissettore

VARADY
19.2105
 18 cm

Mini-Phlebextraktor
 Mini Phleboextractor
 Mini extracteur pour phlébite
 Mini Flebextractor
 Mini-estrattore per flebiti

VARADY
19.2106
 18 cm



für Leberblindpunktion, mit Stoppsonde
for liver blind puncture, with stopping probe
pour ponction aveugle du foie, avec clou d'arrêt
para punción ciega del hígado, con aguja limitadora
per puntatura con ago limitatore

MENGHINI

- 19.3000 1,00 x 35 mm
- 19.3001 1,00 x 70 mm
- 19.3010 1,20 x 70 mm
- 19.3011 1,20 x 100 mm
- 19.3020 1,40 x 70 mm
- 19.3021 1,40 x 100 mm
- 19.3030 1,60 x 70 mm
- 19.3040 1,80 x 80 mm
- 19.3041 1,80 x 100 mm



für gezielte Leberpunktion
for controlled liver puncture
pour ponction contrôlée du foie
para punción controlada del hígado
per puntatura controllata del fegato

MENGHINI

- 19.3043 1,40 x 168 mm
- 19.3044 1,80 x 168 mm



QUINCKE

- 19.3100 0,7 x 76 mm
- 19.3105 0,7 x 89 mm
- 19.3110 1,0 x 76 mm
- 19.3115 1,0 x 89 mm
- 19.3120 1,2 x 76 mm
- 19.3125 1,2 x 89 mm



KLIMA-ROSSEGER

- 19.3300 1,8 x 35 mm

Sternal-Punktionskanüle
Sternal puncture needle
Aiguille pour la ponction sternale
Aguja para punción esternal
Ago per la puntura dello sterno



FRANKLIN-SILVERMAN

19.3051 2,0 x 100 mm

19.3053 2,5 x 145 mm



Knochenmark
 Bone Marrow
 Moelle osseuse
 Médula
 Midollo osseo

WESTERMAN (JENSEN)

19.3060 LL 50 x Ø 2,4 mm 13 G

19.3061 LL 85 x Ø 2,4 mm 13 G

19.3062 LL 100 x Ø 3,0 mm 11 G

19.3064 LL 150 x Ø 3,0 mm 11 G

19.3065 LL 100 x Ø 4,0 mm 9 G

19.3066 LL 150 x Ø 4,0 mm 9 G

Brustfellpunktionskanülen
 Pleura puncture needles
 Aiguilles à ponction pleurale
 Agujas para la punción de la pleura
 Aghi per la puntura della pleura

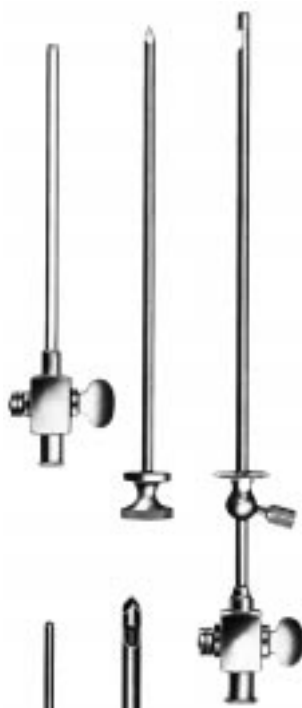

ABRAMS

19.3500

Ø 4 x 90mm



RAMEL

19.3510



Insufflationskanülen mit Durchflußhahn, Luer-Lock
Insuflation Canulas with stop-cock, Luer-Lock
Canules pour insufflation avec robinet de circulation, Luer-Lock
Cánulas para insuflación con llave de paso, Luer-Lock
Cannule per insufflazione con rubinetto regolatore del passaggio,

VERRES

19.3550	55 x 2,0 mm
19.3552	100 x 2,0 mm
19.3554	120 x 2,0 mm
19.3556	140 x 2,0 mm



Mit Knopfende und Schlaucholive
with button end and tube connector
aboutonné avec connecteur pour tubes
abotonado con conexión para tubos
bottonuta, con raccordo per tubi

VENAE

19.3399	1,00 x 80 mm
19.3400	1,20 x 80 mm
19.3401	1,40 x 80 mm
19.3402	1,50 x 80 mm
19.3403	1,60 x 80 mm
19.3404	1,80 x 80 mm
19.3405	2,00 x 80 mm

Heparinnadeln
Heparin Flushing Needles
Aiguilles pour héparine
Agujas para heparin
Agi per eparina



HEPARIN
19.3600 4,5 cm / 3 mm



HEPARIN
19.3602 5,5 cm / 3,7 mm



MOCK
19.3610 6 cm

Pudendus-Anästhesiekanüle
Pudendus Anaesthesia Needle
Canule pour anesthésie transvaginale
Cánula para anestesia transvaginal
Cannula per anestesia trasvaginale



IOWA
56.0740 15 cm

56.0749
Kanüle 1,00 x 185 mm
Cannula 1,00 x 185 mm
Canule 1,00 x 185 mm
Cánula 1,00 x 185 mm
Cannula 1,00 x 185 mm



REKORD

19.5001	1 ml Luer
19.5002	2 ml Luer
19.5003	5 ml Luer
19.5004	10 ml Luer
19.5005	20 ml Luer
19.5007	50 ml Luer

Spritzen mit Glaszylinder und LUER-Konus
 Syringes with glass barrel and LUER cone
 Seringues avec cylindre en verre et cône LUER
 Jeringas con cilindro de vidrio y cono LUER
 Siringhe con cilindro di vetro e cono LUER



19.5011	1 ml Luer
19.5012	2 ml Luer
19.5013	5 ml Luer
19.5014	10 ml Luer
19.5015	20 ml Luer
19.5017	50 ml Luer

Ersatzzylinder mit LUER-Konus
 Spare barrels with LUER cone
 Cylindres de rechange avec cône LUER
 Cilindros de repuesto con cono LUER
 Cilindri di ricambio con cono LUER



REKORD

19.5021	1 ml Luer-Lock
19.5022	2 ml Luer-Lock
19.5023	5 ml Luer-Lock
19.5024	10 ml Luer-Lock
19.5025	20 ml Luer-Lock
19.5027	50 ml Luer-Lock

Spritzen mit Glaszylinder und LUER-Lock Ansatz
 Syringes with glass barrel and LUER-Lock connection
 Seringues avec cylindre en verre et raccord LUER-Lock
 Jeringas con cilindro de vidrio y conexión LUER-Lock
 Siringhe con cilindro di vetro e raccordo LUER-Lock



19.5031	1 ml Luer-Lock
19.5032	2 ml Luer-Lock
19.5033	5 ml Luer-Lock
19.5034	10 ml Luer-Lock
19.5035	20 ml Luer-Lock
19.5037	50 ml Luer-Lock

Ersatzzylinder mit LUER-Lock
 Spare barrels with LUER-Lock
 Cylindres de rechange avec LUER-Lock
 Cilindros de repuesto con LUER-Lock
 Cilindri di ricambio con LUER-Lock



- 19.5801** 2 ml Luer-Lock
- 19.5802** 5 ml Luer-Lock
- 19.5803** 10 ml Luer-Lock
- 19.5804** 20 ml Luer-Lock

Dreiring-Spritzen, Glaszylinder, bewegliche Ringe, LUER-Lock
3-Ring Syringes, glass barrel, revolving rings, LUER-Lock
Seringues à 3 anneaux, cylindre en verre, LUER-Lock
Jeringas de 3 anillos girables, cilindro de vidrio, LUER-Lock
Siringe da 3 anelli mobili, cilindro di vetro, LUER-Lock



- 19.5032** 2 ml Luer-Lock
- 19.5033** 5 ml Luer-Lock
- 19.5034** 10 ml Luer-Lock
- 19.5035** 20 ml Luer-Lock

Ersatzzylinder mit LUER-Lock
Spare barrels with LUER-Lock
Cylindres de rechange avec LUER-Lock
Cilindros de repuesto con LUER-Lock
Cilindri di ricambio con LUER-Lock

Kanülen für Spritzen 19.5001-19.5007, 19.5021-19.5027
Cannulas, Needles for Syringes 19.5001-19.5007, 19.5021-19.5027
Canules, Aiguilles pour seringues 19.5001-19.5007, 19.5021-19.5027
Cánulas, agujas para jeringas 19.5001-19.5007, 19.5021-19.5027
Cannule per siringhe 19.5001-19.5007, 19.5021-19.5027

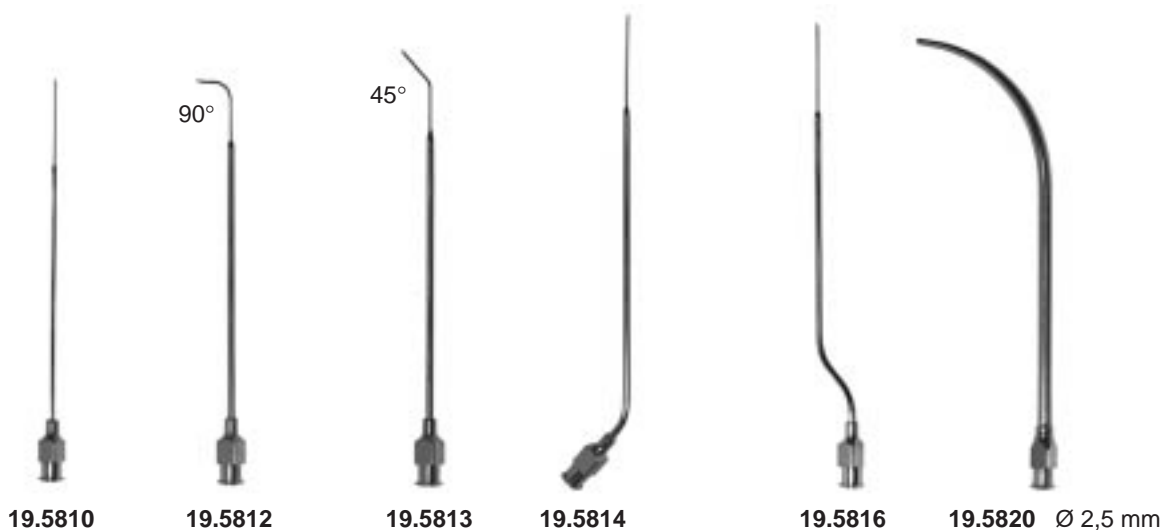

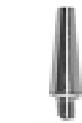

JANET
19.5898



JANET
19.5899



JANET
19.5881 50 ml
19.5882 75 ml
19.5883 100 ml
19.5884 150 ml
19.5885 200 ml

JANET
19.5891 50 ml
19.5892 75 ml
19.5893 100 ml
19.5894 150 ml
19.5895 200 ml

mit 2 auswechselbaren Aufsätzen
with 2 exchangeable tips
avec 2 raccords interchangeable
con 2 puntas intercambiables
con 2 punte intercambiabili



AUTOFILL

32.0280

Ganzmetall-Ohrspritze LL selbstfüllend, 10 ml, komplett
All metal ear syringe LL, self-filling, 10 ml, complete
Seringue auriculaire LL, tout métal, auto-remplissante, 10 ml, complète
Jeringa para oído LL, todo metal, auto-rellena, 10 ml, completa
Siringa auricolare LL, di metallo, auto-riempente, 10 ml, completa



AUTOFILL

32.0281

10 ml
Spritze / Syringe
Seringue / Jeringa
Siringa



32.0282

Ventilaufsatz
Valve Attachment
Soupape
Válvula de conexión
Valvola di connessione



32.0283

Verbindungsschlauch
Connecting tube
Tube de connection
Tubo de conexión
Tubo di connessione



32.0284

Saugansatz
Suction Nozzle
Embout à aspiration
Pieza de succión
Aspiratore



32.0285

Schutzschild
Protecting Shield
Plaque de protection
Disco protector
Disco protettivo



32.0286

Metallolive
Metal Olive
Olive en métal
Oliva metálica
Oliva in metallo



32.0287

Konischer Ansatz
Conical Tip
Pointe conique
Punta cónica
Punta conica



32.0288

Geknöpfte Ansatz
Button-end Tip
Pointe boutonnée
Punta de botón
Punta a bottone



32.0289

Gewindeaufsatz
Threaded Tip
Pointe filetée
Punta de rosca
Punta filettata

REINER-ALEXANDER

32.0301 75cc

32.0301 100cc

32.0301 150cc

komplett mit Teller und 2 Ansätzen
complete with protecting shield and 2 tips
complète avec plaque de protection et 2 embouts
completo con disco protector y 2 puntas
completo con disco protettivo e 2 punte



32.0297

Kanüle für Wasserspritze 32.0296
Cannula only for 32.0296
Canule seule pour 32.0296
Canula, sola para 32.0296
Canula, sola per 32.0296

32.0296

Ganzmetallspritze LL, selbstfüllend 10 ml, mit 1 Kanüle 32.0297
Metal water syringe LL, self-filling 10 ml, with Cannula 32.0297
Seringue à eau métallique LL, auto-remplissante, 10 ml, avec canule 32.0297
Jeringa metallica de agua LL, auto-rellena, 10 ml, con canula 32.0297
Siringa d'acqua di metallo LL, auto-riempente, 10 ml, con canula 32.0297



19.5929

Aufsatz für Ampullenspritzen 19.5918, 19.5922
Tip only for syringes 19.5918, 19.5922
Embout seuls pour Seringues 19.5918, 19.5922
Adaptador sola para Jeringas 19.5918, 19.5922
Punta sola per cartuccia 19.5918, 19.5922

DENTAL

19.5918 1,8 ml
19.5922 2,2 ml

Ampullenspritzen komplett mit Aufsatz Nr. 19.5929
Cartridge Syringes complete with Tip 19.5929
Seringues à carpules complète avec embout 19.5929
Jeringas para cartucho-ampollas completa con adaptador 19.5929
Siringhe per cartuccia-fiala completa con punta 19.5929

PRO-MED

VERBAND, GIPS
DRESSING, PLASTER CAST
PANSEMENT ET PLATRE
VENDAJES Y YESO
BENDAGGI E GESSO



Verband- und Gipsscheren siehe Seiten 135 - 138
Bandage- and Plaster Scissors see pages 135 - 138
Ciseaux à pansements et à plâtre voir pages 135 - 138
Tijeras para vendajes y per yeso véase pag. 135 - 138
Forbici per bendaggi e per gesso vedi pag. 135 - 138



ESMARCH
21.0010 18 cm



REINER
21.0020 19 cm



HOPKINS
21.0030 20 cm



WIGMORE
21.0050 19 cm



ENGEL
21.0060 16 cm



BERGMANN
21.0070 23 cm

Verband- und Gipsscheren siehe Seiten 135 - 138
Bandage- and Plaster Scissors see pages 135 - 138
Ciseaux à pandements et à plâtre voir pages 135 - 138
Tijeras para vendajes y per yeso véase pag. 135 - 138
Forbici per bendaggi e per gesso vedi pag. 135 - 138



WOLFF
21.0100 18 cm



WOLFF
21.0102 24 cm

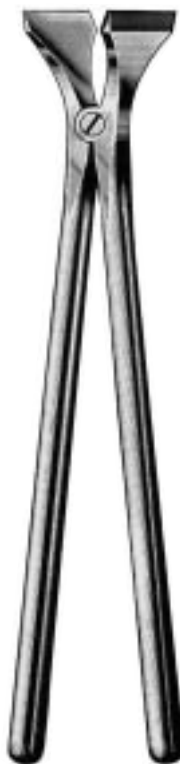

BEESON
21.0110 30 cm



HENNING
21.0120 27 cm



WALTON
21.0130 23 cm



STILLE-HAGLUND
21.0140 28 cm



HERMANN
21.0150 46 cm



OSCILLOW-E.P.

21.3010 230 V, 50 Hz, 500 W

21.3011 110 V, 60 Hz, 500 W

Technische Daten:

230 Volt, 50 Hz bzw. 110 Volt, 60Hz, 500 W
6500 - 24000 Schwingungen pro Minute
Motorschutzschalter, funkentstört und schutzisoliert
Schutzklasse II DIN/EN 60601, Typ BF

mit

21.3007 1 Sägeblatt Ø 50 mm
21.3008 1 Sägeblatt Ø 65 mm
21.3009 2 Schraubenschlüssel
21.3019 1 Bereitschaftskoffer

Technical Data:

230 Volt, 50 cycles, resp. 110 Volt, 60 cycles, 500 Watt
6500 - 24000 oscillations per minute
overload protection, interferences suppression and shockproof
Safety class II DIN/EN 60601, Type BF

with:

21.3007 1 Saw blade Ø
21.3008 1 Saw blade Ø 65 mm
21.3009 2 Wrenches
21.3019 1 Plastic case

Caractéristiques techniques:

230 Volt, 50 Hz resp. 110 Volt, 60Hz, 500 Watt
6500 - 24000 oscillations par minute
disjoncteur-protecteur, antiparasité et double isolation
Classe de protection II DIN/EN 60601, Type BF

avec.

21.3007 1 Lame de rechange Ø 50 mm
21.3008 1 Lame de rechange Ø 65 mm
21.3009 2 Clés
21.3019 1 Valise plastique

Especificaciones técnicas:

230 Voltios, 50 HZ o 110 Voltios 60 HZ, 500 Vatios
6500 - 24000 oscilaciones por minuto
protección coner sobrecarga, supresión de las interferencias
y aislamiento protector
Clase de protección II DIN/EN 60601, Tipo BF

con:

21.3007 1 Hoja di sierra Ø 50 mm
21.3008 1 Hoja di sierra Ø 65 mm
21.3009 2 Llaves
21.3019 1 Maletin de plástico

Dati tecnici:

230 Vold, 50 HZ o 110 Volt, 60 HZ, 500 Watt
6500 - 24000 oscillazioni al minuto
Interruttore di protezione, suppressione d'interferenze e isolato
Classe protettiva II DIN/EN 60601, Tipo BF

con:

21.3007 1 Lame di ricambio Ø 50 mm
21.3008 1 Lame di ricambio Ø 65 mm
21.3009 2 Chiavi
21.3019 1 Valigetta di plastico



OSCILLOW-VAC 220 V

21.3030

Gipssäge mit Staubabsaugung

Electric Plaster Cast Cutter with Dust Evacuation

Scie à plâtre électrique avec aspiration de la poussière

Sierra para vendajes completo con vacuum y soporte movil

Sega elettrica per gessi con aspirazione di polvo

21.3039

FILTERSET für OSCILLOW-VAC Gipssäge 21.3030

6 Staubbeutel, 6 Dufttabletten, 1 HEPA-Filter

FILTERSET for OSCILLOW-VAC

6 dustbags, 6 deo-tabs, 1 HEPA-Filter

Jeu de consommables pour OSCILLOW-VAC

6 sacs, 1 filtre, 6 pastilles déodorant, 1 filtre HEPA

FILTERSET para OSCILLOW-VAC

6 sacs de papel de repuesto, 6 tabletas aromáticas, 1 filtro HEPA

FILTERSET per OSCILLOW-VAC

6 Sachetti di carta di ricambio, 6 pillole aromatici, 1 filtro HEPA

Ersatz-Sägeblätter
Spare saw blades
Lames de rechange
Hojas di sierra
Lame di ricambio



21.3005 50 mm

21.3006 65 mm

für Hartverbände
for synthetic casts
pour plâtre synthétique
para vendajes sinteticós
per ingessature in materia plastica

21.3007 50 mm

21.3008 65 mm

für Gipsverbände
for plaster casts
pour plâtre naturel
para vendajes de yeso
per bendaggi en gesso



21.3009

2 Schraubenschlüssel zum Sägeblattwechsel
2 wrenches for exchange of saw blades
2 clés pour échanger les lames de scie
2 llaves para cambia las hojas de sierra
2 chiavi per cambiare lame per sega



21.3019

Bereitschaftskoffer für OSCILLOW Gipssäge
Plastic case for OSCILLOW Plaster Saw
Valise plastique pour OSCILLOW scie à plâtre
Maletin de plástico para OSCILLOW sierra para vendajes
Valigetta di plastica per sega per gessi

BARIATRISCHE CHIRURGIE
BARIATRIC SURGERY
CHIRURGIE BARIATRIQUE
CIRUGIA BARIATRICA
CHIRURGIA BARIATRICA



Scheren / Scissors / Ciseaux / Tijeras / Forbici



METZENBAUM
13.0614
36 cm



METZENBAUM
13.0615
36 cm

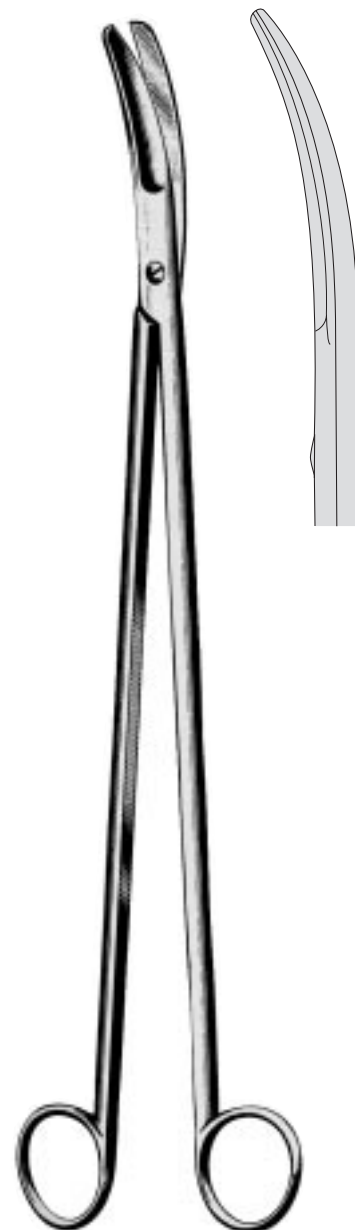

CRAFOORD
13.1083
31,5 cm



Scheren / Scissors / Ciseaux / Tijeras / Forbici

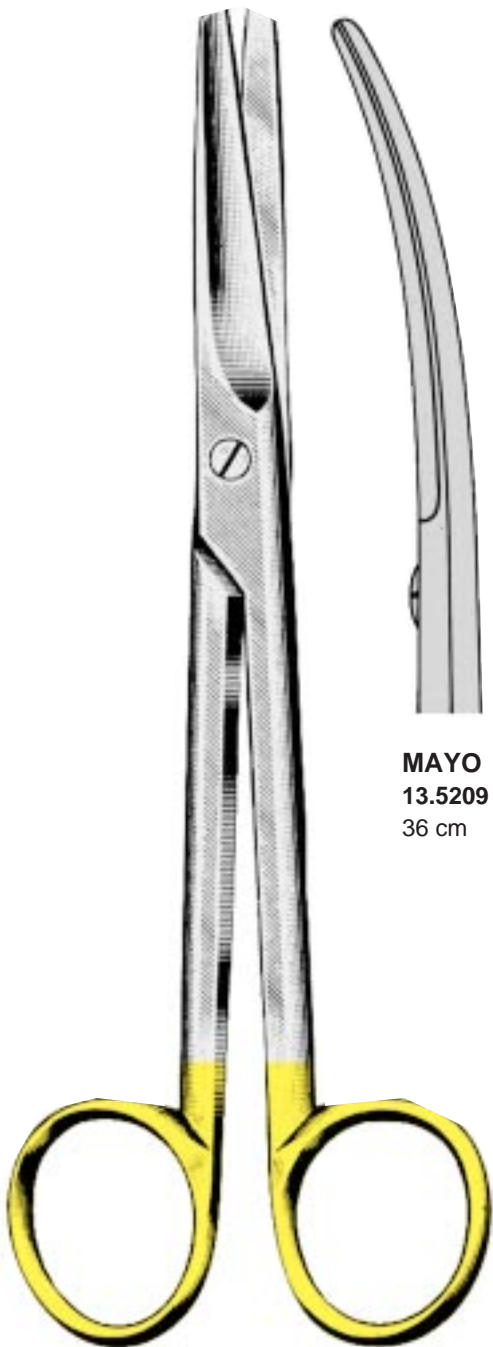

MAYO
13.5208
36 cm

MAYO
13.5209
36 cm



METZENBAUM
13.5382
36 cm

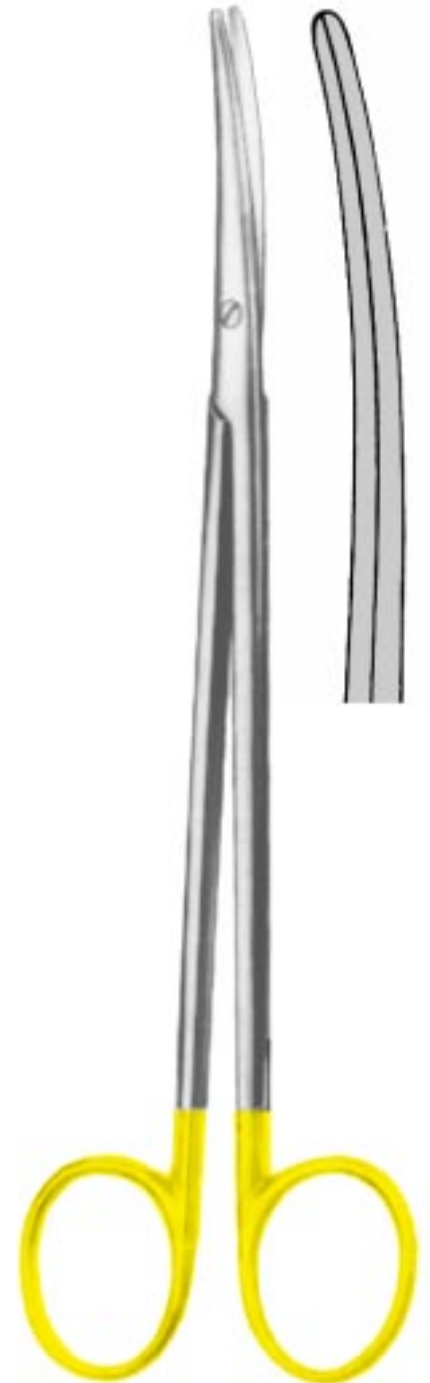

METZENBAUM
13.5383
36 cm

Pinzetten / Dressing- and Tissue Forceps / Pincés à dissection / Pinzas de disección / Pinze per dissezione



DRESSING
14.0132
36 cm



TISSUE
14.0632
36 cm
1x2



RUSSIAN
14.0938
36 cm

Pinzetten / Dressing- and Tissue Forceps / Pincès à dissection /
Pinzas de disección / Pinze per dissezione

Arterien- und Präparierklemmen
Hemostatic- and Dissecting Forceps
Pincès hémostatiques et à disséquer
Pinzas hemostáticas y para preparación
Pinze emostatiche e per preparazione



SINGLE
14.0958
36 cm



DEBAKEY
14.1018
36 cm/2 mm



DEBAKEY-COLLIER
15.0269
36 cm

Arterien- und Präparierklemmen / Hemostatic- and Dissecting Forceps /
Pinces hémostatiques et à disséquer / Pinzas hemostáticas y para preparación /
Pinze emostatiche e per preparazione



ROCHESTER-PEAN
15.0478
36 cm



ROCHESTER-PEAN
15.0479
36 cm

Arterien- und Präparierklemmen / Hemostatic- and Dissecting Forceps /
Pinces hémostatiques et à disséquer / Pinzas hemostáticas y para preparación /
Pinze emostatiche e per preparazione



CRAFOORD-SELLORS
15.0497
36 cm



SAROT
15.0503
36 cm

Arterien- und Präparierklemmen / Hemostatic- and Dissecting Forceps /
Pincés hémostatiques et à disséquer / Pinzas hemostáticas y para preparación /
Pinze emostatiche e per preparazione



ROCH.-OCHSNER
15.0634
36 cm



ROCH.-OCHSNER
15.0635
36 cm

Arterien- und Präparierklemmen / Hemostatic- and Dissecting Forceps /
Pincas hémostatiques et à disséquer / Pinzas hemostáticas y para preparación /
Pinze emostatiche e per preparazione



GEMINI
15.0778
36 cm



GUYON
15.1936
36 cm



HARRINGTON
40.0705
36 cm



ALLIS
48.0019
36 cm
5 x 6

Arterien- und Präparierklemmen / Hemostatic- and Dissecting Focreps /
Pinces hémostatiques et à disséquer / Pinzas hemostaticas y para preparaci3n /
Pinze emostatiche e per preparazione

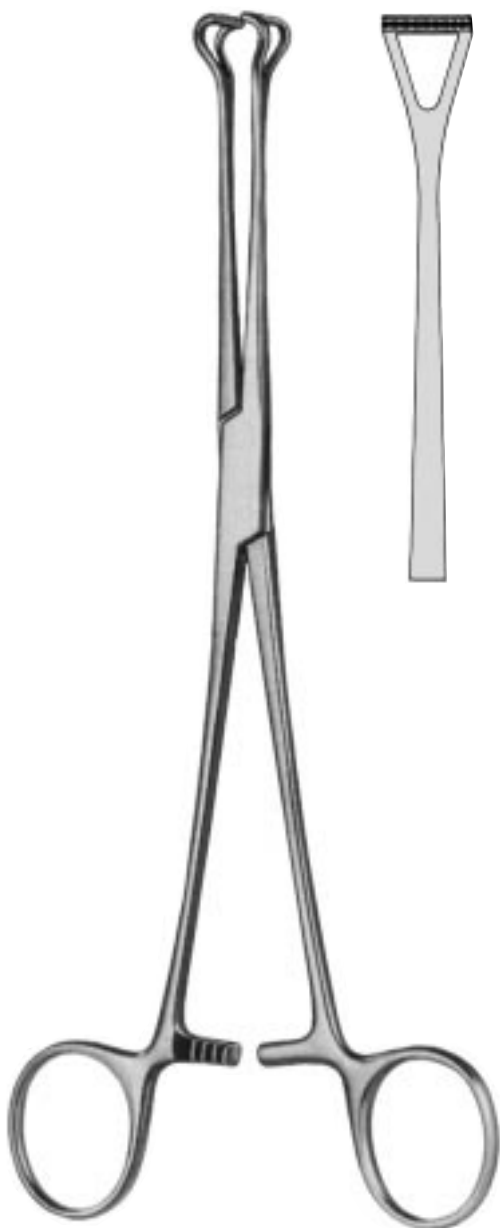

BABCOCK
48.0069
36 cm

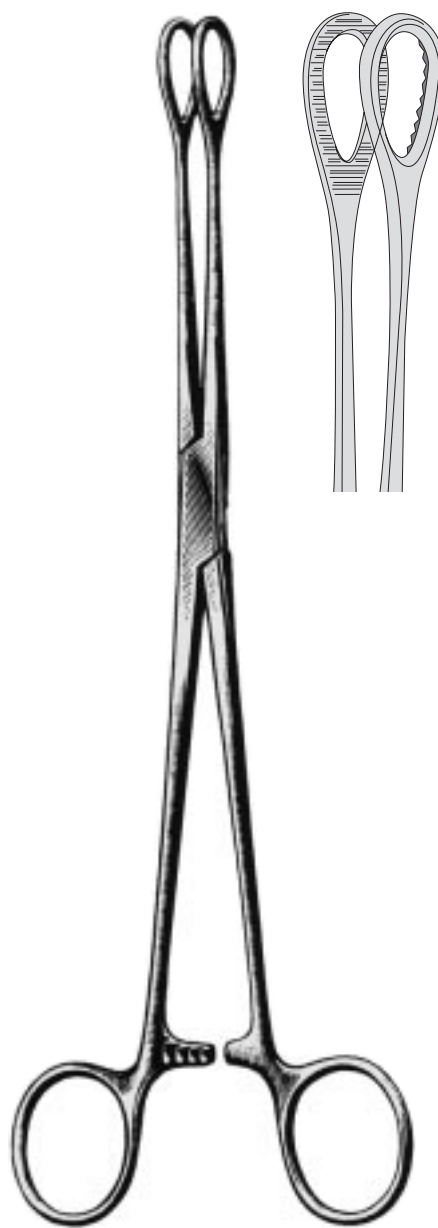

FOERSTER
16.0436
36 cm
gerieft
serrated
strié
estriada
con striatura

Wundhaken und Wundsperrer / Retractors / Ecarteurs / Separadores / Divaricatori



CUSHING
17.0576
36 cm
11x12 mm



DEAVER
17.1275
36cm / 25 mm



DEAVER
17.1275.36
36 cm / 65 mm

Wundhaken und Wundsperrer / Retractors / Ecarteurs / Separadores / Divaricatori

**O'SULLIVAN-O'CONNOR**

17.6265 bestehend aus:
17.6266 Rahmen mit 2 Seitenvalven 150 x 25 mm
17.6262 2 Valven 85 x 45 mm
17.6263 1 Valve 70 x 105 mm

consisting of:
17.6266 Frame with 2 lateral valves 150 x 25 mm
17.6262 2 Valves 85 x 45 mm
17.6263 1 Valve 70 x 105 mm

comprenant:
17.6266 Cadre avec 2 valves latérales 150 x 25 mm
17.6262 2 Valves 85 x 45 mm
17.6263 1 Valve 70 x 105 mm

compuesto de:
17.6266 Cuadro con 2 valvas laterales 150 x 25 mm
17.6262 2 Valvas 85 x 45 mm
17.6263 1 Valva 70 x 105 mm

composta da:
17.6261 Telaio con 2 valve laterali 150 x 25 mm
17.6262 2 Valve 85 x 45 mm
17.6263 1 Valva 70 x 105 mm



Nadelhalter / Needle holders / Porte-aiguilles / Porta-agujas / Portaghi



MAYO-HEGAR
18.0092 35 cm
18.0094 37 cm
18.0096 40 cm



CRILE-WOOD
18.0110
36 cm

Nadelhalter / Needle holders /
Porte-aiguilles / Porta-agujas /
Portaghi

Probes, Suction Tubes / Sondes, Tubes d'aspiration /
Sondas, Tubos de aspiración / Sonde, Tubi d'aspirazione



MAYO-HEGAR

18.1090 30 cm
18.1092 35 cm
18.1094 40 cm



19.0117
30,0 cm / 1,5 mm
19.0127
30,0 cm / 2,0 mm
19.0128
40,0 cm / 2,0 mm

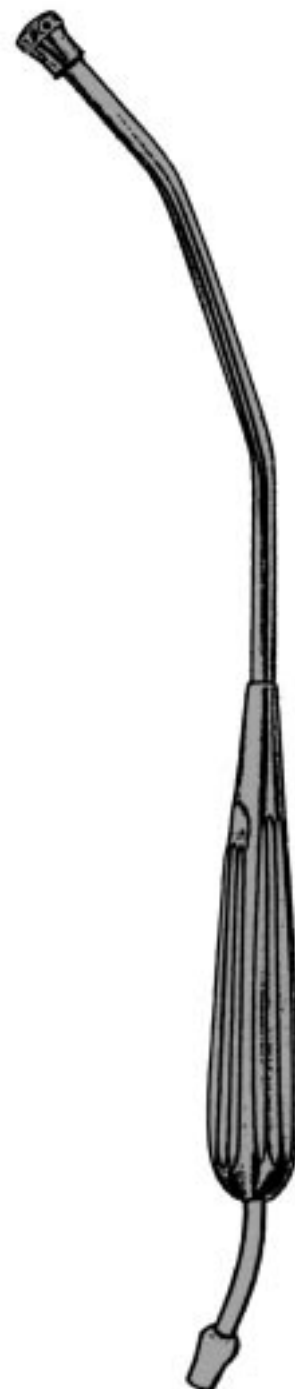

YANKAUER

19.0711 36 cm
19.0712 40 cm
19.0713 46 cm

Probes, Suction Tubes / Sondes, Tubes d'aspiration / Sondas, Tubos de aspiración / Sonde, Tubi d'aspirazione



POOLE
19.0722 30 cm
19.0723 35 cm
19.0724 46 cm



COOLEY
19.0750
36cm Ø 8mm



WIJNEN
19.0738
33cm Ø 12 mm

Knochenchirurgie / Bone Surgery / Chirurgie osseuse / Cirugia osea / Chirurgia ossea



- 23.0790 35 cm, 13 mm
- 23.0792 35 cm, 16 mm
- 23.0794 35 cm, 19 mm
- 23.0796 35 cm, 25 mm



- 28 cm
- 23.1220.28 # 0000
 - 23.1222.28 # 000
 - 23.1224.28 # 00
 - 23.1226.28 # 0
 - 23.1228.28 # 1
 - 23.1230.28 # 2
 - 23.1232.28 # 3
 - 23.1234.28 # 4
 - 23.1236.28 # 5
 - 23.1238.28 # 6
- 38 cm
- 23.1220.38 # 0000
 - 23.1222.38 # 000
 - 23.1224.38 # 000
 - 23.1226.38 # 0
 - 23.1228.38 # 1
 - 23.1230.38 # 2
 - 23.1232.38 # 3
 - 23.1234.38 # 4
 - 23.1236.38 # 5
 - 23.1238.38 # 6

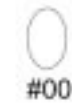

- 28 cm
- 23.1221.28 # 0000
 - 23.1223.28 # 000
 - 23.1225.28 # 00
 - 23.1227.28 # 0
 - 23.1229.28 # 1
 - 23.1231.28 # 2
 - 23.1233.28 # 3
 - 23.1235.28 # 4
 - 23.1237.28 # 5
 - 23.1239.28 # 6
- 38 cm
- 23.1221.38 # 0000
 - 23.1223.38 # 000
 - 23.1225.38 # 00
 - 23.1227.38 # 0
 - 23.1229.38 # 1
 - 23.1231.38 # 2
 - 23.1233.38 # 3
 - 23.1235.38 # 4
 - 23.1237.38 # 5
 - 23.1239.38 # 6



Knochenchirurgie / Bone Surgery / Chirurgie osseuse / Cirugia osea / Chirurgia ossea



BANDIT-LEKSELL
40 cm



23.2897
3mm



23.2898
5mm



23.2899
8mm



DALE RONGEUR
23.2921
37 cm

AUTOPSIE
POST MORTEM
AUTOPSIE
AUTOPSIA
AUTOPSIA

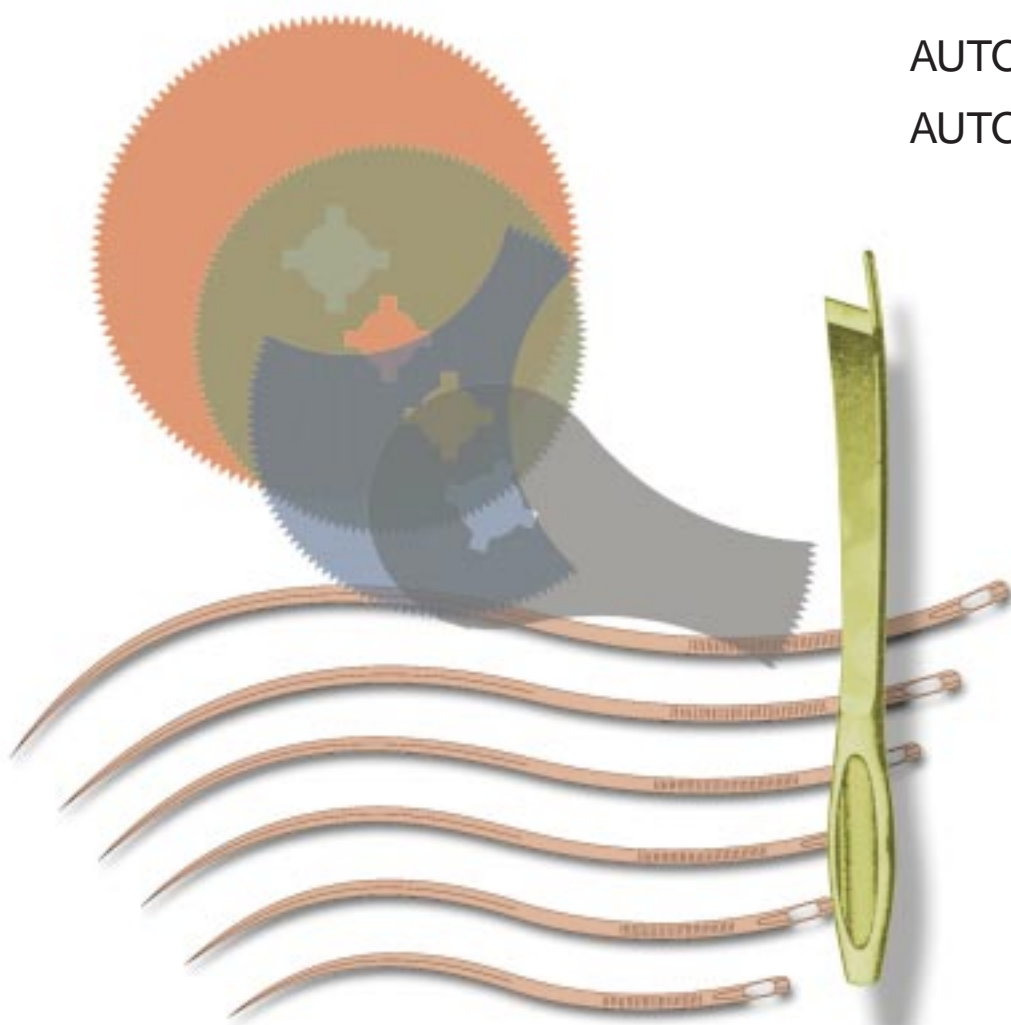



60.0001
Autopsie-Besteck
Post-Mortem Set
Set à autopsie
Juego de autopsia
Set per autopsia

Oszillierende elektrische Autopsiesägen
Oscillating Electric Autopsie Saws
Scies électrique oscillante pour autopsie
Sierras eléctrica oscilante para autopsia
Seghe elettrica oscillante per autopsia



60.0100 230 VOLT
60.0110 110 VOLT

komplett mit

- 60.0118 1 Imbusschlüssel für Autopsiesäge
- 60.0119 2 Gabelschlüssel für Autopsiesäge
- 60.0131 1 Sägeblatt rund Ø 50 mm
- 60.0132 1 Sägeblatt rund Ø 65 mm
- 60.0137 1 Segmental Sawblade y 65 mm circular

complete with:

- 60.0118 1 hexagonal screwdriver
- 60.0119 2 wrenches
- 60.0131 1 sawblade round Ø 50 mm
- 60.0132 1 sawblade round Ø 65 mm
- 60.0137 1 Segmental Sawblade Ø 65 mm circular

complète avec:

- 60.0118 1 tournevis hexagonal
- 60.0119 2 clefs
- 60.0131 1 lame de scie Ø 50 mm
- 60.0132 1 lame de scie Ø 65 mm
- 60.0137 1 lame de scie à segment Ø 65 mm

completa con:

- 60.0118 1 atornillador hexagonal
- 60.0119 2 llaves
- 60.0131 1 hoja de sierra Ø 50 mm
- 60.0132 1 hoja de sierra Ø 65 mm
- 60.0137 1 hoja de sierra segmentar Ø 65 mm

completa con:

- 60.0118 1 chiave esagonale
- 60.0119 2 chiavi
- 60.0131 1 lama di sega Ø 50 mm
- 60.0132 1 lama di sega Ø 65 mm
- 60.0137 1 lama di sega segmentazione Ø 65 mm

Technische Daten:

230 Volt, 50 Hz bzw. 110 Volt, 60Hz, 500 W
6500 - 24000 Schwingungen pro Minute
Motorschutzschalter, funkentstört und schutzisoliert
Schutzklasse II DIN/EN 60601, Typ BF

Technical Data:

230 Volt, 50 cycles, resp. 110 Volt, 60 cycles, 500 Watt
6500 - 24000 oscillations per minute
overload protection, interferences suppression and shockproof
Safety class II DIN/EN 60601, Type BF

Caractéristiques techniques:

230 Volt, 50 Hz resp. 110 Volt, 60Hz, 500 Watt
6500 - 24000 oscillations par minute
disjoncteur-protecteur, antiparasité et double isolation
Classe de protection II DIN/EN 60601, Type BF

Especificaciones técnicas:

230 Voltios, 50 HZ o 110 Voltios 60 HZ, 500 Vativos
6500 - 24000 oscilaciones por minuto
protección conter sobrecarga, supresión de las interferencias
y aislamiento protector
Clase de protección II DIN/EN 60601, Tipo BF

Dati tecnici:

230 Volt, 50 HZ o 110 Volt, 60 HZ, 500 Watt
6500 - 24000 oscillazioni al minuto
Interruttore di protezione, suppressione d'interferenze e isolato
Classe protettiva II DIN/EN 60601, Tipo BF

Zubehör für Autopsiesäge / Accessories for Autopsy Saw / Accessoires pour scie à autopsie /
Accesorios para sierra para autopsia / Accessori per seghe per autopsia



60.0118
Imbusschlüssel
Chuck key
Tournevis hexagonal
Atornillador hexagonal
Chiave esagonale



60.0119
Gabelschlüssel, Paar
Spanners, pair
Paire de clés
Par de llaves
Paio de chiavi



60.0125
Begrenzungsscheibe für Sägeblätter
Limiter-disk for sawblades
Disque à limiter pour lames de scie
Disco para limitación para sierras
Disco di limitazione per lima



60.0131 Ø 50 mm
60.0133 Ø 50 mm
hart / hard / dure / dura / duro



60.0132 Ø 65 mm
60.0134 Ø 65 mm

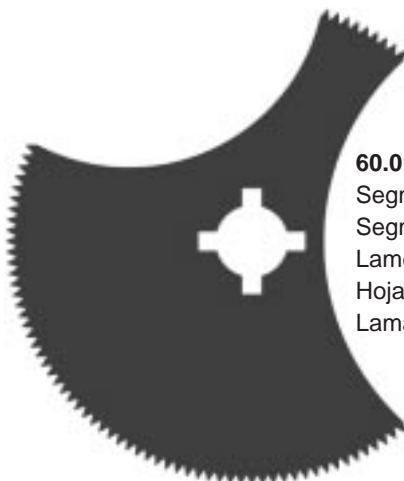

60.0137
Segment Sägeblatt Ø 65 mm
Segmental Sawblade Ø 65 mm circular
Lame de scie à segment Ø 65 mm
Hoja de sierra segmentar Ø 65 mm
Lama segmentar Ø 65 mm

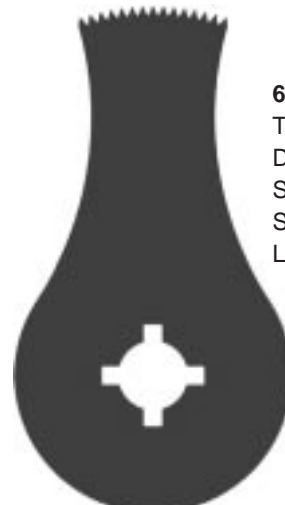

60.0138
Tiefensäge bis 20 mm
Deep cutting saw up to 20 mm
Scie profonde jusqu'à 20 mm
Sierra profunda hasta 20 mm
Lama a taglio di profondità da 20 mm

Schädelspalter
Skull breaker
Burin casse-crâne
Cinzel rompe-craneo
Tagliacranio



60.1000
14cm



60.1001
13cm/23mm



60.1020
28,5 cm
links
left
gauche
izquierdo
sinistra



BRUNETTI 60.1021
28,5 cm
rechts
right
droite
derecho
destra



Rachiotom
Rachiotome
Rachiotome
Raquiótomo
Rachiotomo

60.1030
22 cm



60.1100
25 cm / 20 mm



60.1200
23,5 cm

Muskelhaken
Muscle hook
Crochet musculaire
Gancho muscular
Uncino muscular



60.1300
10,5 cm

Sektionsnadeln
Post Mortem Needles
Aiguilles d'autopsie
Agujas para autopsia
Aghi per autopsia

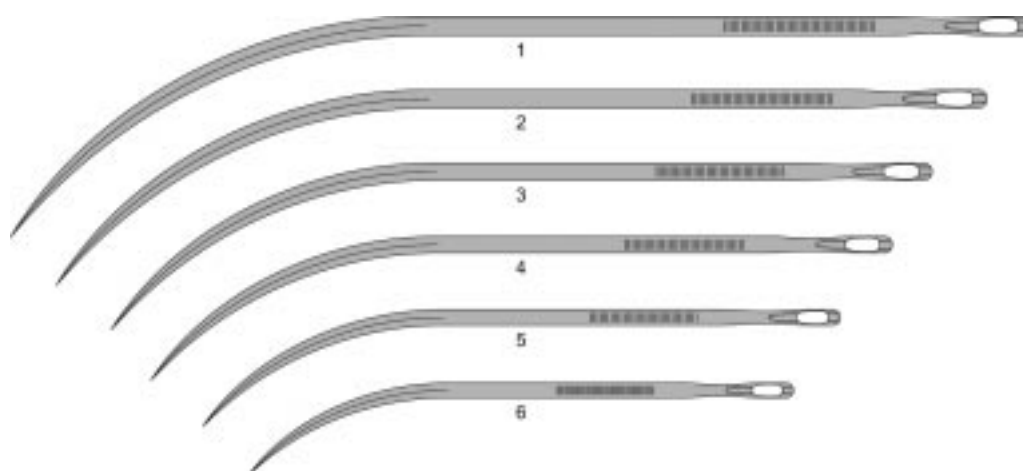

- | | |
|----------------|------------|
| 60.2001 | 1 / 12 St. |
| 60.2002 | 2 / 12 St. |
| 60.2003 | 3 / 12 St. |
| 60.2004 | 4 / 12 St. |
| 60.2005 | 5 / 12 St. |
| 60.2006 | 6 / 12 St. |

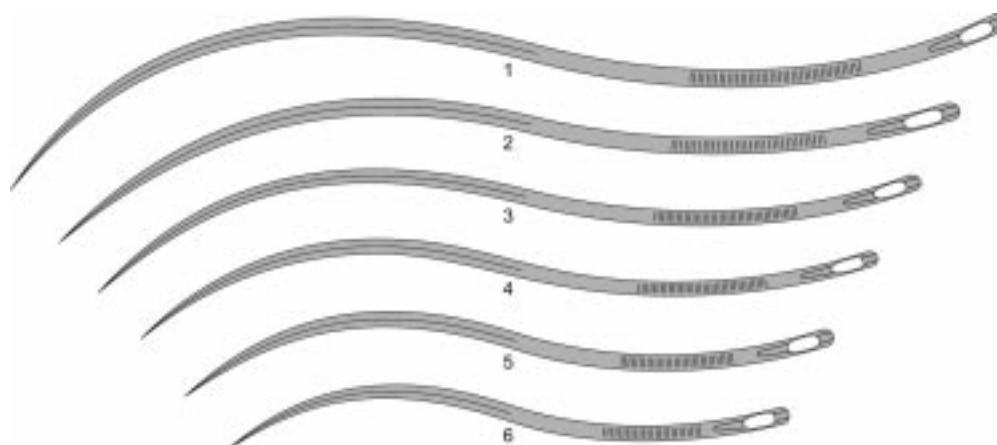

- | | |
|----------------|------------|
| 60.2011 | 1 / 12 St. |
| 60.2012 | 2 / 12 St. |
| 60.2013 | 3 / 12 St. |
| 60.2014 | 4 / 12 St. |
| 60.2015 | 5 / 12 St. |
| 60.2016 | 6 / 12 St. |

Sterilisation
Sterilization
Sterilisation
Esterilización
Sterilizzazione

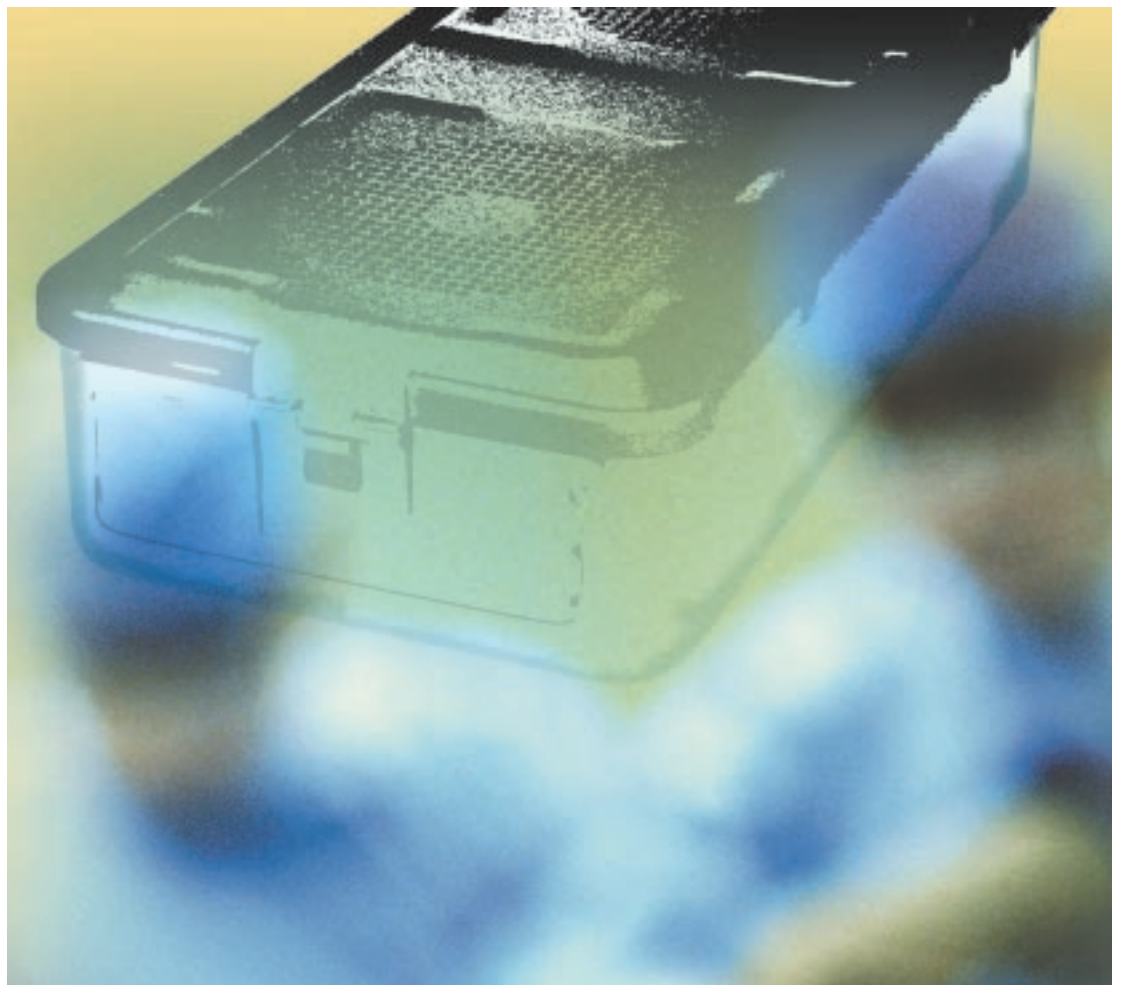

1/2 Container, ALU

Deckel gelocht und farbig
 Lid perforated and colored
 Couvercle perforé et coloré
 Tapas perforadas y coloreados
 Coperchio perforato e colorato



L x B x H mm

285x280x100	80.6001	80.6002	80.6003	80.6004	80.6005	80.6006
285x280x135	80.6011	80.6012	80.6013	80.6014	80.6015	80.6016
285x280x150	80.6021	80.6022	80.6023	80.6024	80.6025	80.6026
285x280x200	80.6031	80.6032	80.6033	80.6034	80.6035	80.6036
285x280x260	80.6041	80.6042	80.6043	80.6044	80.6045	80.6046

Zubehör · Accessories · Accessoires · Accesorios · Accessori

für 1/2 Container for 1/2 Containers pour 1/2 Containers para 1/2 Contenedores per 1/2 Contenitori



Siebkörbe
Wire baskets
Plateaux inox
Bandejas inoxidable
Cestelli in acciaio fino

80.6203	255x245x 30 mm
80.6205	255x245x 50 mm
80.6207	255x245x 70 mm
80.6210	255x245x100 mm



Spannrahmen
Cloth fixing frames
Cadres fixe-toile
Cuadros para fijar panos
Telai fissateli

80.6231	255x255 mm
----------------	------------



80.6232	255x255x30 mm
----------------	---------------



Teiler
Deviders
Cloisons
Tabiques
Divisori

80.6240	255x245x130 mm
----------------	----------------

3/4 Container, ALU

Deckel gelocht und farbig
Lid perforated and colored
Couvercle perforé et coloré
Tapas perforadas y coloreados
Coperchio perforato e colorato

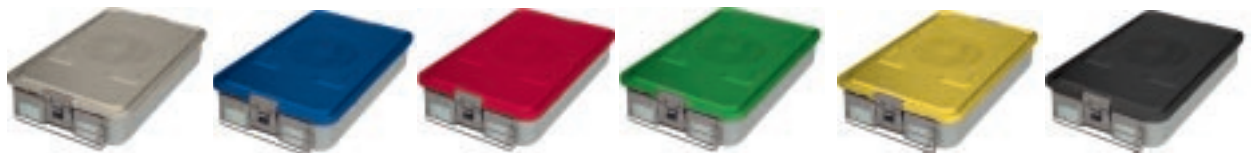

L x B x H mm

465x280x100	80.6301	80.6302	80.6303	80.6304	80.6305	80.6306
465x280x135	80.6311	80.6312	80.6313	80.6314	80.6315	80.6316
465x280x150	80.6321	80.6322	80.6323	80.6324	80.6325	80.6326

Zubehör · Accessories · Accessoires · Accesorios · Accessori

für
3/4 Container

for
3/4 Containers

pour
3/4 Containers

para
3/4 Contenedores

per
3/4 Contenitori



Siebkörbe
Wire baskets
Plateaux inox
Bandejas inoxidable
Cestelli in acciaio fino

80.6503	405x245x 30 mm
80.6505	405x245x 50 mm
80.6507	405x245x 70 mm
80.6510	405x245x100 mm



Spannrahmen
Cloth fixing frames
Cadres fixe-toile
Cuadros para fijar panos
Telai fissateli

80.6531	405x255 mm
---------	------------

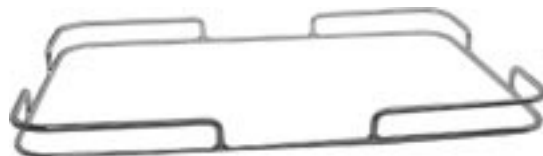

80.6532	405x255x30 mm
---------	---------------



Teiler
Deviders
Cloisons
Tabiques
Divisori

80.6540	405x250x130 mm
---------	----------------



80.6541	405x250x130 mm
---------	----------------

1/1 Container, ALU

Deckel gelocht und farbig
 Lid perforated and colored
 Couvercle perforé et coloré
 Tapas perforadas y coloreadas
 Coperchio perforato e colorato

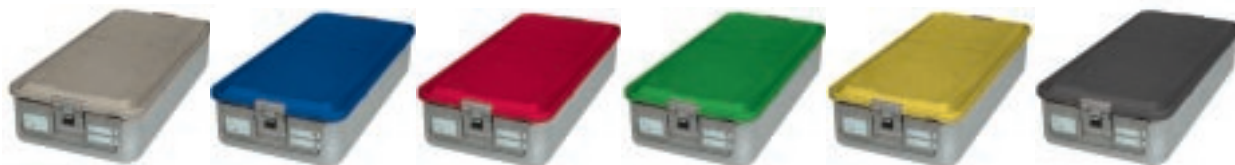

L x B x H mm

580x280x100	80.6601	80.6602	80.6603	80.6604	80.6605	80.6606
580x280x135	80.6611	80.6612	80.6613	80.6614	80.6615	80.6616
580x280x150	80.6621	80.6622	80.6623	80.6624	80.6625	80.6626
580x280x200	80.6631	80.6632	80.6633	80.6634	80.6635	80.6636
580x280x260	80.6641	80.6642	80.6643	80.6644	80.6645	80.6646

Zubehör · Accessories · Accessoires · Accesorios · Accessori

für
1/1 Container

for
1/1 Containers

pour
1/1 Containers

para
1/1 Contenedores

per
1/1 Contenitori



Siebkörbe
Wire baskets
Plateaux inox
Bandejas inoxidable
Cestelli in acciaio fino

80.6803	485x285x 30 mm
80.6805	485x285x 50 mm
80.6807	485x285x 70 mm
80.6810	485x285x100 mm
80.6813	540x285x 30 mm
80.6815	540x285x 50 mm
80.6817	540x285x 70 mm
80.6820	540x285x100 mm

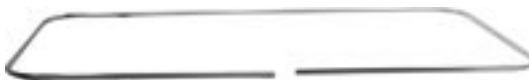

Spannrahmen
Cloth fixing frames
Cadres fixe-toile
Cuadros para fijar panos
Telai fissateli

80.6841 545x245 mm

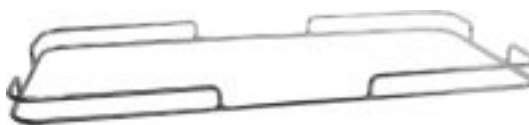

80.6842 545x245x30 mm



Teiler
Deviders
Cloisons
Tabiques
Divisori

80.6850 510x250x130 mm



80.6851 510x250x130 mm

Flach- und Mini-Container, ALU eloxiert

Flat- and Mini-Containers, ALU
 Containers plates et mini en aluminium
 Contenadores planos y mini de aluminio
 Contenitori piatti e mini in alluminio



Deckel gelocht und farbig
 Lid perforated and colored
 Couvercle perforé et coloré
 Tapas perforadas y coloreados
 Coperchio perforato e colorato



Flach – Flat – Plat – Plano – Platto

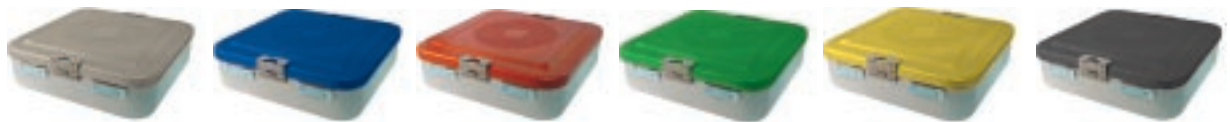

L x B x H mm

285x280x55	80.7001	80.7002	80.7003	80.7004	80.7005	80.7006
285x280x85	80.7011	80.7012	80.7013	80.7014	80.7015	80.7016

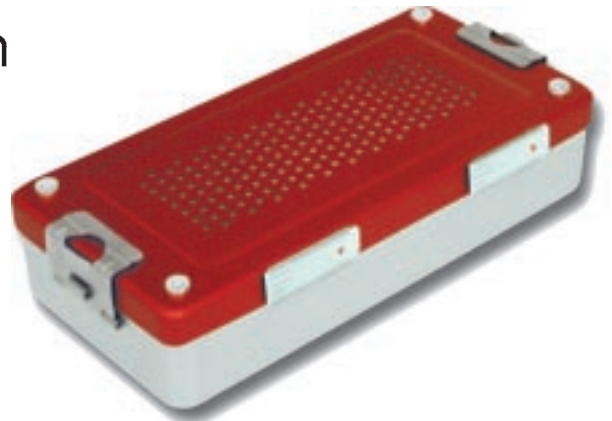

Mini

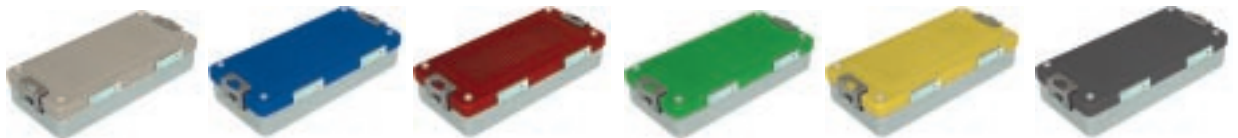

L x B x H mm

300x140x40	80.7301	80.7302	80.7303	80.7304	80.7305	80.7306
300x140x70	80.7311	80.7312	80.7313	80.7314	80.7315	80.7316
300x140x100	80.7321	80.7322	80.7323	80.7324	80.7325	80.7326

Zubehör · Accessories · Accessoires · Accesorios · Accessori

für FLACH- und
MINI-Container

for FLAT- and
MINI-Containers

pour Containers
PLARTS et MINI

para Contenedores
PLANOS y MINI

per Contenitori
PIATTI e MINI



Siebkorb mit Deckel
Wire basket with lid
Panier avec couvercle
Cestillo con cobertera
Cestello con coperchio

80.7410 267x125x50 mm



Siebeinlage f. MINI-Container
Separate base for MINI-Container
Fond du crible pour MINI-Container
Base para MINI-Container
Base per MINI-Container

80.7420 270x125 mm



Spannrahmen für Mini-Container
Cloth fixing frames for MINI-Container
Cadres fixe-toile pour MINI-Container
Cuadros para fijar panos para MINI-Container
Telai fissateli per MINI-Container

80.7431 270x125 mm

Endoskopie-Container, ALU eloxiert

Endoscopy-Containers, ALU

Containers a endoscopie en alumium

Contenedores para endoscopiade aluminio

Contenitori per endoscopia in alluminio

Deckel gelocht und farbig

Lid perforated and colored

Couvercle perforé et coloré

Tapas perforadas y coloreados

Coperchio perforato e colorato



L x B x H mm

250x60x50

80.7501

80.7503

80.7504

450x70x70

80.7511

80.7513

80.7514

Zubehör · Accessories · Accessoires · Accesorios · Accessori

Siebköbe Endoskopie

Wire baskets Endoscopy

Paniers Endoscopie

Cestillos Endoscopia

Cestilli Endoscopia

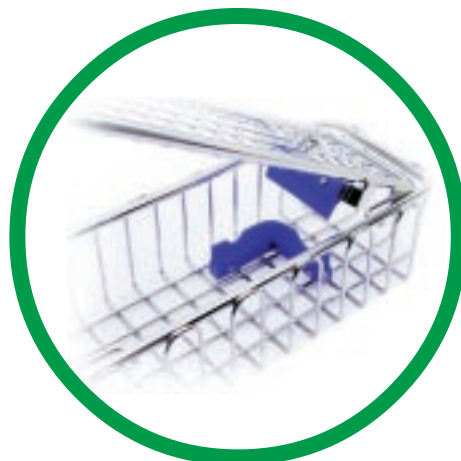

80.7551 290x 80x50 mm

80.7552 460x 80x50 mm

80.7553 640x150x77 mm

Dental Container, ALU eloxiert

Dental Containers, ALU

Containers pour instrumentation dentaire en aluminium

Contenedores para instrumental dental aluminio

Contentori per strumenti dentali in alluminio

Deckel gelocht und farbig

Lid perforated and colored

Couvercle perforé et coloré

Tapas perforadas y coloreados

Coperchio perforato e colorato

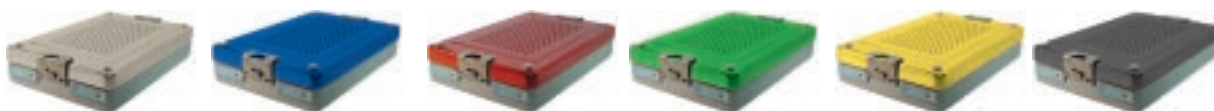

L x B x H mm

310x190x40	80.7601	80.7602	80.7603	80.7604	80.7605	80.7606
310x190x65	80.7611	80.7612	80.7613	80.7614	80.7615	80.7616
310x190x130	80.7621	80.7622	80.7623	80.7624	80.7625	80.7626

Zubehör · Accessories · Accessoires · Accesorios · Accessori

Siebkorb mit Deckel

Wire basket with lid

Panier avec couvercle

Cestillo con cobertera

Cestello con coperchio



80.7801

274x172x43 mm

Spannrahmen für Dental-Container

Cloth fixing frames for dental containers

Cadres fixe-toile pour container dentaire

Cuadros para fijar panos para container dental

Telai fissateli per contenitori dentali



80.7821

274x172 mm

Zubehör · Accessories · Accessoires · Accesorios · Accessori

Kennzeichnungsschilder, Aluminium ohne Text
Identification labels, aluminium, neutral
Plaquettes d'identificationen aluminium, neutres
Placas de identificación, aluminio, neutral
Targhette di identificazione d'alluminio, neutre



80.7901 80.7902 80.7903 80.7904 80.7905 80.7906

Kennzeichnungsschilder, Aluminium graviert
Identification labels, aluminium, engraved
Plaquettes d'identificationen aluminium, gravées
Placas de identificación, aluminio, grabadas
Targhette di identificazione d'alluminio, incise



80.7911 80.7912 80.7913 80.7914 80.7915 80.7916

Sortiermagazin für Kennzeichnungsschilder
Rack for identification labels
Magasin à plaquettes d'identification
Cajita para seleccionar placas
Cassetta da selezione tharghette

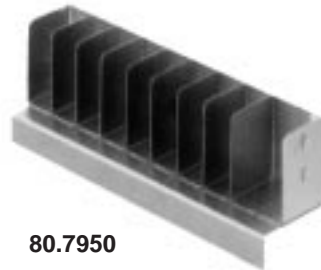

80.7950

Indikator-Schilder, Papier, 100 St.
Indicating labels, paper, 100 pcs.
Etiquettes d'identification en papier, les 100
Etiquetas indicadoras, papel 100 c/u
Targhette con indicatore, papel, 100 pezzi

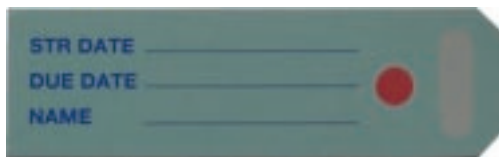

80.7960

klein / small / petite / pequenas / piccolo

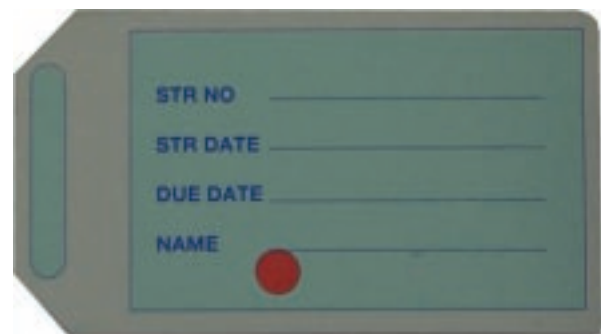

80.7962

groß / large / grande / grande / grande

Sicherungsplomben, Plastik, 100 St.
Safety Seals, plastic, 100 pcs.
Scellés de sécurité, plastique, les 100
Precintos de seguridad,plastico 100 c/u
Sigilli di sicurezza, plastica, 100 pezzi



80.7980

Zubehör · Accessories · Accessoires · Accesorios · Accessori

Filterspender für 1/2, 3/4, 1/1 Container-Filter
Filter Dispenser for 1/2, 3/4, 1/1 Container-Filters
Présentoir de filtres pour les 1/2, 3/4, 1/1 Containers
Distribuidor de filtros para los 1/2, 3/4, 1/1 Containers
Distributore di filtri per 1/2, 3/4, 1/1 Container



80.8000

Filterhalter für 1/2, 3/4, 1/1 Container
Filter Holder for 1/2, 3/4, 1/1 Containers
Fixe-filtres pour 1/2, 3/4, 1/1 Containers
Sujetafiltros para los 1/2, 3/4, 1/1 Containers
Fermafiltri per 1/2, 3/4, 1/1 Container



80.8010

Filter, Einmalgebrauch, Papier 1000 St.
Single use filters, paper 1000 pcs.
Filtres en papier à usage unique, les 1000
Filtros, monouso, papel, 1000 c/u
Filtri, monouso, carta, 1000 pezzi

FILTER, Papier für 1/2, 3/4, 1/1 Container
for 1/2, 3/4, 1/1 Containers
pour 1/2, 3/4, 1/1 Containers
para los 1/2, 3/4, 1/1 Containers
per 1/2, 3/4, 1/1 Container



80.8050

FILTER, Papier für MINI-Container
for MINI-Containers
pour MINI-Containers
para MINI-Containers
per MINI-Containers



80.8052

FILTER, Papier für DENTAL Container
for DENTAL-Containers
pour DENTAL-Containers
para DENTAL-Containers
per DENTAL-Containers



80.8054

Zubehör · Accessories · Accessoires · Accesorios · Accessori

Langzeit-Textilfilter, 1 St.
Long-term textile filters, 1 pc.
Filtres en textile, la pièce
Filtros de textil, 1 c/u
Filtri tessili, il pezzo

FILTER, Textil für 1/2, 3/4, 1/1 Container
for 1/2, 3/4, 1/1 Containers
pour 1/2, 3/4, 1/1 Containers
para los 1/2, 3/4, 1/1 Containers
per 1/2, 3/4, 1/1 Container



1 St.

80.8060

FILTER, Textil für MINI-Container
for MINI-Containers
pour MINI-Containers
para MINI-Containers
per MINI-Containers



1 St.

80.8062

FILTER, Textil für DENTAL Container
for DENTAL-Containers
pour DENTAL-Containers
para DENTAL-Containers
per DENTAL-Containers



1 St.

80.8064

Sterilisier-Tücher, Baumwolle
Sterilizing Drapes, cotton
Champs à stérilisation, coton
Paños de esterilización de algodón
Pannos di sterilizzazione, cotone

80.8100 40 x 60 cm
80.8105 85 x 85 cm
80.8110 100 x 140 cm
80.8115 275 x 125 cm
80.8120 245 x 245 cm



**80.8100-
80.8120**

Noppenmatten, Silikon
Silicone Pads
Tapis port-instruments, silicone
Tapices porta instrumentos de silicona
Tapetti porta-strumenti in silicone

80.8131 275 x 125 mm
80.8132 225 x 225 mm
80.8133 300 x 300 mm

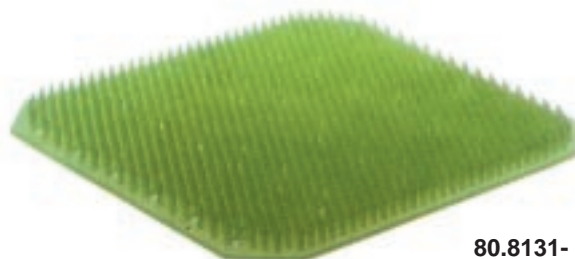

**80.8131-
80.8133**

Zubehör · Accessories · Accessoires · Accesorios · Accessori

Fixierklammern für Tücher
Fixation Clamps for Drapes
Pinces fixe-toiles
Grapas para fijar paños
Pinze di fillaggio per teli

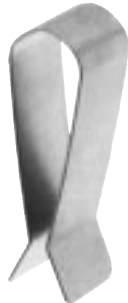

80.8150



80.8160 Ø 7 - 12 mm
80.8161 Ø 12 - 16 mm
80.8162 Ø 16 - 26 mm
80.8163 Ø 26 - 36 mm
80.8164 Ø 36 - 45 mm



80.8160-
70.8164

Fixierfedern
Spiral Supports
Ressorts spiraux
Apoyos con resorte spiral
Supporte a molle

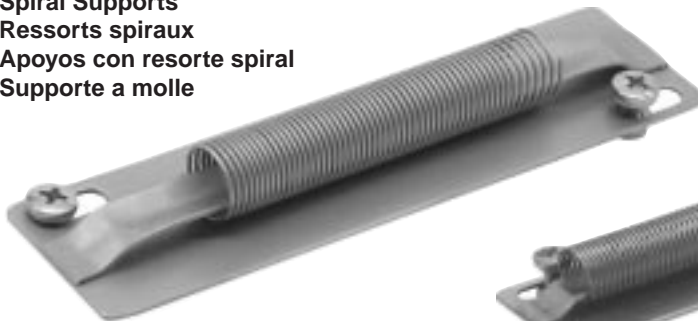

80.8191 115 x 30 mm

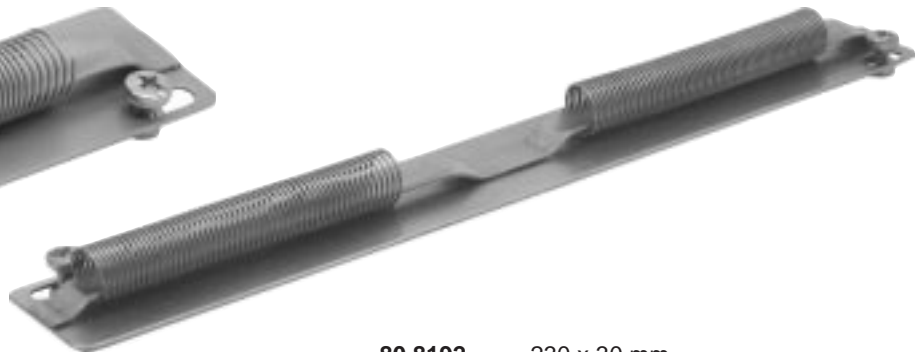

80.8192 230 x 30 mm

80.8140 SILIKON Fixierstreifen Set

bestehend aus:

80.8141 1 Silikon Streifen 246 x 13 mm

80.8142 2 Silikon Halteknöpfe

SILICONE Storage Strip Set

consisting of:

80.8141 1 Silicone Storage Strip 246x13 mm

80.8142 2 Silicone Fastening Knobs

SILICONE bande porte instrum. 243 x 13 mm

Jeu comprenant:

80.8141 1 Silicone bande à sécurité 243 x 13 mm

80.8142 2 Silicone boutons à fixation

SILICONE tira de protección 243 x 13 mm

Juego compuesto de:

80.8141 1 Silicone tira de protección 243 x 13 mm

80.8142 2 Silicone botones de fijar

SILICONE strisce per assicurare 243x13 mm

Set composto da:

80.8141 1 Silicone strisce per assicurare 243x13 mm

80.8142 2 Silicone botoni de fissare

80.8141 246x13 mm



80.8142 2 Stück / 2 pieces / 2 pièces / 2 piezas / 2 pezzi

Zubehör · Accessories · Accessoires · Accesorios · Accessori

Haltestifte, Trennbleche
Fixing bolts, Dividers
Attaches de fixation, Séparateurs
Piñons para fijar, Separadores
Perne di fissaggio, Divisori

Haltestift für Instrumente
for instruments
pour instruments
para instrumentos
per strumenti



80.8201

Haltestift für Trennbleche
for Dividers
pour Séparateurs
para Separadores
per Divisori



80.8202

Trennbleche
Dividers
Séparateurs
Separadores
Divisori

80.8211 50x20 mm
80.8212 130x20 mm
80.8213 225x20 mm
80.8214 460x20 mm

Winkelbleche
Angled Dividers
Séparateurs angulés
Separadores angulados
Divisori angulate

80.8221 110 mm
80.8222 170 mm
80.8223 230 mm
80.8223 470 mm

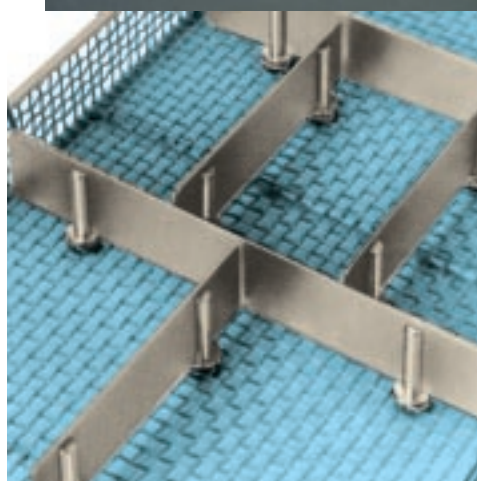
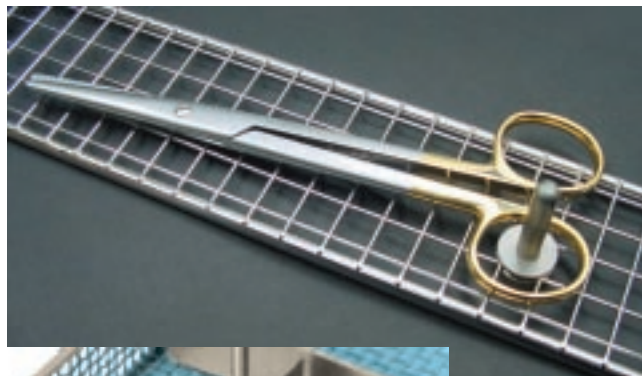

Sterilisierahmen für 8 Mikro-Instrumente
Sterilizing Rack for 8 Micro-Instruments
Chevalet à Sterilisation pour 8 Micro-Instruments
Porta-instrumentos para 8 Micro Instrumentos
Telaio per sterilizzazione per 8 micro-strumenti

80.3190 190 x 36 x 35 mm

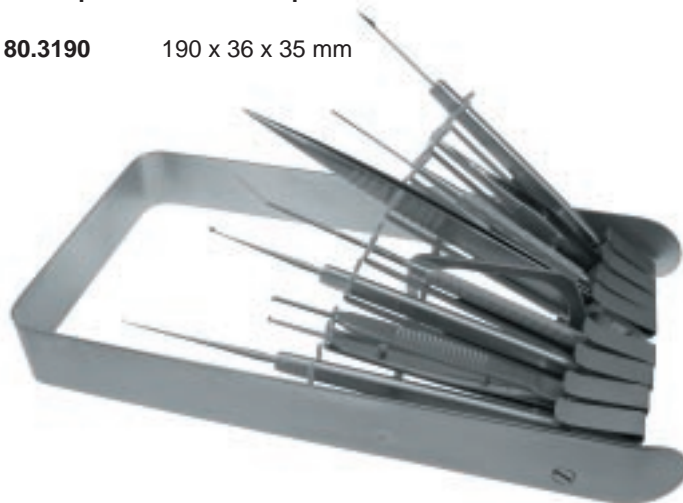

Sterilisation · Sterilization · Sterilisation · Esterilizacion · Sterilizzazione

Container für mikrochirurgische Instrumente
Containers for microsurgical instruments
Containers pour instruments de microchirurgie
Contenedores para instrumental microcirugia
Contentori per strumenti per microchirurgia



80.3112 300x220x55 mm
80.3114 285x280x55 mm
80.3116 400x290x55 mm



80.3162 300x220x75 mm
80.3164 285x280x75 mm
80.3166 400x290x75 mm

Sterilisiertrommeln
Sterilizing drums
Boites rondes à sterilisation
Tambores de esterilizacion
Cestelli rotondi per sterilizzazione

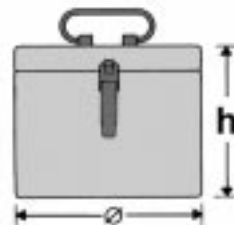

80.4002-
80.4028



80.4040-
80.4064

SCHIMMELBUSCH

80.4002	120x120 mm	80.4016	240x240 mm
80.4004	140x140 mm	80.4018	290x160 mm
80.4006	160x120 mm	80.4020	290x240 mm
80.4008	160x150 mm	80.4022	340x160 mm
80.4010	190x150 mm	80.4024	340x240 mm
80.4012	190x190 mm	80.4026	390x190 mm
80.4014	240x160 mm	80.4028	390x290 mm

KONRICH

80.4040	96 x 99 mm	80.4054	285 x 240 mm
80.4042	156 x 146 mm	80.4056	334 x 158 mm
80.4044	188 x 140 mm	80.4058	334 x 238 mm
80.4046	188 x 185 mm	80.4060	384 x 138 mm
80.4048	239 x 160 mm	80.4062	384 x 188 mm
80.4050	239 x 240 mm	80.4064	384 x 288 mm
80.4052	285 x 160 mm		

Zubehör · Accessories · Accessoires · Accesorios · Accessori

Pflegeöl für chirurgische Instrumente
Lubricating Oil for Surgical Instruments
Huile pour lubrifier les instruments chirurgicaux
Lubrificante para las instrumentos quirúrgicos
Olio per lubrificazione di strumenti chirurgici

80.0010 50 cc.
80.0012 250 cc.
80.0014 1000 cc.



80.0010

Wattenspenden
Cotton dispensers
Distributeurs de coton
Dispensores de algodón
Distributore del cotone

80.1000 75 x 50 Ø
80.1002 115 x 75 Ø



80.1000-
80.1002

Watteabfallbehälter
Cotton Waste Collector
Poubelle pour coton
Recipiente para algodón
Recipiente per cotone usato

80.1010 75 x 50 Ø
80.1012 100 x 75 Ø



80.1010-
80.1012

Nadeldosen
Needle Cases
Boîtes à aiguilles
Estuches para agujas
Astucci per aghi

80.2000 65x17 mm
komplett - complete - complet - completo - completo



80.2000

80.2009 Innendose allein für 80.2000
insert only for 80.2000
boîte intérieure seulement pour 80.2000
Caja interior suelta para 80.2000
Scatola interna sola per 80.2000



80.2009

Zubehör · Accessories · Accessoires · Accesorios · Accessori

80.2020 150x95x13 mm



80.2020

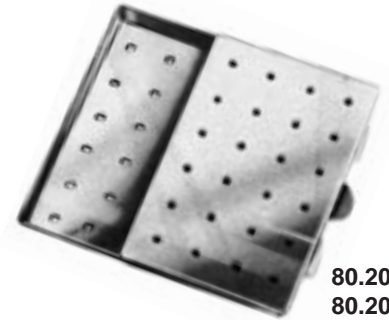

80.2030-
80.2032

80.2030 50x25x4,5 mm

80.2031 65x42x8,0 mm

80.2032 75x25x4,5 mm

SAUERBRUCH

80.2060



80.2060

Meßbecher
Measuring jugs
Gobelets gradués
Copas graduadas
Misurini

80.2070 0,25 l.

80.2072 0,5 l.

80.2074 1,0 l.

80.2076 1,5 l.

80.2078 2,0 l.



80.2070 -
80.2090

Petrischale
Petri Dish
Boîte de Petri
Cubeta de Petri
Scodella di Petri

80.2090 100 X 20 mm



80.2090

Zubehör · Accessories · Accessoires · Accesorios · Accessori

**Nierenschalen
 Kidney bowls
 Bassins réniformes
 Riñoneras
 Padelle reniformi**

80.2100	170 x 37 mm
80.2101	205 x 45 mm
80.2102	250 x 39 mm
80.2104	275 x 45 mm



**80.2100 -
 80.2104**

**Runde Schalen
 Round Bowls
 Cuvettes rondes
 Cubetas redondas
 Scodelle rotonde**

80.2200	40 x 19 mm	0,05 l
80.2202	60 x 30 mm	0,07 l
80.2204	80 x 40 mm	0,14 l
80.2206	100 x 50 mm	0,20 l
80.2208	120 x 55 mm	0,35 l
80.2210	150 x 65 mm	0,70 l



**80.2200 -
 80.2210**



**80.2240 -
 80.2262**

80.2240	150 x 74 mm	0,75 l
80.2242	160 x 65 mm	1,00 l
80.2244	220 x 70 mm	2,00 l
80.2246	225 x 90 mm	2,50 l
80.2248	240 x 95 mm	3,00 l
80.2250	255 x 115 mm	4,00 l
80.2252	260 x 130 mm	4,50 l
80.2254	300 x 105 mm	6,00 l
80.2256	310 x 120 mm	6,00 l
80.2258	320 x 140 mm	8,00 l
80.2260	380 x 125 mm	11,00 l
80.2262	400 x 150 mm	14,00 l

**Kappenzangen mit Behälter und Deckel
 Sterilizing Forceps with jar and lid
 Pincas à stérilisation avec éprouvette et couvercle
 Pinzas para esterilización con recipiente y tapa
 Pinze per sterilizzazione con recipiente e coperchio**

80.2270	25 cm
80.2272	32 cm



**80.2270 -
 80.2272**

Zubehör · Accessories · Accessoires · Accesorios · Accessori

Standgefäße

Jars

Réipients cylindriques

Tarros

Recipienti cilindrici

80.2280	30 x 90 mm
80.2282	50 x 100 mm
80.2284	50 x 135 mm
80.2286	50 x 180 mm
80.2288	80 x 130 mm
80.2290	80 x 180 mm
80.2292	100 x 200 mm



80.2280 -
80.2292

Medizinbecher und -löffel

Medicine Cups and Spoons

Gobelets et cuillère à médicaments

Vasos y cuchara para medicamentos

Bicchieri e cucchiaio per medicinali

80.2300	30 cc
80.2302	50 cc



80.2300



80.2302

80.2310	6,8 x 1,8 cm
---------	--------------



80.2310

80.2315	11 x 2 cm
---------	-----------



80.2315

Zubehör · Accessories · Accessoires · Accesorios · Accessori

Instrumenttenablegeplatten
Instrument depositing trays
Plateaux pour déposer les instruments
Bandejas para instrumentos
Vassoi per strumenti

80.2400	210 x 160 x 10 mm
80.2401	240 x 180 x 10 mm
80.2402	310 x 150 x 10 mm
80.2406	310 x 210 x 10 mm
80.2407	400 x 270 x 20 mm
80.2408	420 x 280 x 10 mm

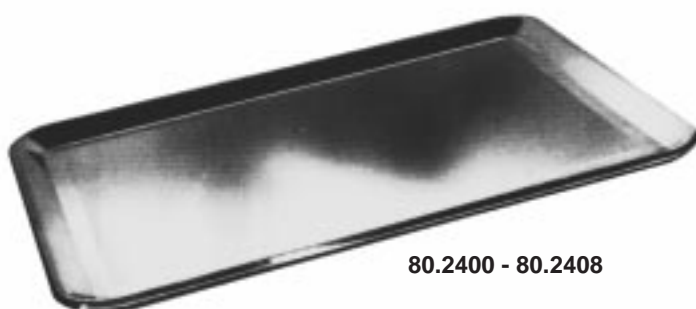

80.2400 - 80.2408

80.2430	230 x 155 x 30 mm
80.2432	300 x 175 x 30 mm
80.2434	300 x 175 x 40 mm
80.2436	350 x 240 x 36 mm
80.2438	400 x 300 x 50 mm



80.2400 - 80.2408

Instrumentenkästen
Instrument Boxes
Boîtes à Instruments
Cajas para instrumentos
Cestelli per strumenti

80.4100	16x10x 3 cm
80.4101	20x10x 5 cm
80.4102	22x15x 5 cm
80.4103	26x15x 5 cm
80.4104	30x20x 5 cm



80.4100 - 80.4104

PRO-MED

INSTRUMENTE GmbH

Gänsäcker 9
D-78532 Tuttlingen · Germany
Tel. +49(0) 74 62/20 42 40
Fax +49(0) 74 62/20 42 49 0
E-Mail: pro-med-tut@t-online.de
www.pro-med-tut.de



INHALTSVERZEICHNIS

TABLE OF CONTENTS

SOMMAIRE

INDICE

INDICE

NUMMERNVERZEICHNIS
NUMERICAL INDEX
INDEX NUMÉRIQUE
INDICE NUMÉRICO
INDICE NUMERICO

Inhaltsverzeichnis**A**

AACHEN Hirnspateln	459
Abortuszangen	284,287
ABRAMS Brustfell-Biopsienadel	546
Absaugrohre	537-539,577
Abziehstein	61
ADAIR Hakenzange	277
ADAMS Skalpelle	58
ADLERKREUTZ chirurgische Pinzetten	153
ADSON anatomische Pinzetten	142,175
ADSON anatomische Pinzetten PROMEDUR	164
ADSON anatomische Pinzetten TITAN	142
ADSON Arterienklemmen	225
ADSON chirurgische Pinzetten	148,149
ADSON chirurgische Pinzetten PROMEDUR	164
ADSON Hypophysen Pinzetten	175
ADSON Nadelhalter	503
ADSON Nervhäkchen	309
ADSON Pinzetten mit LOCHGRIFF	142,148
ADSON Saugkanülen	531
ADSON Wundspreizer	394,395,404
ADSON-BABY Arterienklemmen	225
ADSON-BABY Wundspreizer	400
ADSON-BROWN chirurgische Pinzetten	153
ADSON-BROWN chirurgische Pinzetten PROMEDUR	166
ADSON-BROWN chirurgische Pinzetten TITAN	153
ADSON-DEBAKEY Pinzetten	142
ADSON-GRAEFE Pinzetten	149
ADSON-MIKRO chirurgische Pinzetten	148
ADSON-MIKRO Pinzette mit LOCHGRIFF	142
ADSON-SELECT chirurgische Pinzetten	148
AEBLI feine Augenscheren	67
AEBLI Keratomieschere	74
Aesthesiometer	22
AGRICOLA Tränensack Wundspreizer	390
ALABAMA Strabismuspinzette	203
ALAN-PARKS Mastdarmspreizer	462
Algesimeter	17
ALLEN Darmklemmen	243
ALLEN Kinderdarmklemme	243
ALLIS atraumatische Gewebefaßklemmen	244
ALLIS Gewebefaßklemmen	243
ALLIS-ADAIR Gewebefaßklemme	244
ALLIS-BABY Gewebefaßklemmen	243
ALLISON Lungenspateln	363
ALLPORT Ohrhäkchen	305
ALLPORT Wundspreizer	392
ALM Wundspreizer	391,392
ALY Algesimeter	17
Ampullenspritzen	552
Amputationsmesser	59-60
Anal spreizer	462-463
ANATOMIE Klängenhalter	50
Anatomie-Scheren	93
anatomische Pinzetten	144-146,566
anatomische Pinzetten für bariatrische Chirurgie	144, 566
anatomische Pinzetten FINO	144
anatomische Pinzetten PROMEDUR	164-165
anatomische Pinzetten USA-Model	144
anatomische Pinzetten, TITAN	142-146
ANDERSON-ADSON Wundspreizer	395
Anlege- u. Entfernungszange f. Miniatur-Clips	216
Anlegepinzetten für Micro-Clips	210
ANVIL Nagelspaltzange	33
Aorta- und Atriumhaken	382-384
ARKANSAS Abziehstein	61
ARRUGA Kapselpinzetten	201
ARRUGA Nadelhalter	471
ARRUGA Sperrelevatoren	388
Arterienklemmen	220-236
Arteriotomie-Scheren	79,80,84
ARTERIOTOMIE-Scheren TITAN	80,84
ARTHUR Splitterzangen	162

atraumatische Mikropinzetten	185
atraumatische Mikropinzetten TITAN	185
atraumatische Pinzetten	157-159
atraumatische Pinzetten, TITAN	158-159
Atriumhaken	382-383
AUFRANC-COBRA Knochenheber	369
AUFRIEHT Nasenflügelhaken	307
AUFRIEHT Retraktor	307
AUFRIEHT Scheren für plastische Chirurgie	119
AUSTIN Knüpfpinzetten	160
AUTOFILL Ohrspritzenbesteck	551
Autopsie-Besteck	584
Autopsie-Flachmeißel	587
Autopsiehammer mit Hakengriff	587
Autopsie-Sägen und Zubehör	585,586
AXENFELD Hauthäkchen	303
AYER Chalazionspinzetten	206

B

BABCOCK Gewebefaßzangen	245
BABCOCK Gewebefaßzangen PROMEDUR	246
BABINSKY Reflexhammer	16
BACKHAUS Tuchklemmen	290
BADGLEY Laminektomiespreizer	434
BAINBRIDGE Arterienklemmen	227
BAKES Gallenkanaldilatator	528
BALFOUR Bauchdeckenhalter	415-417
BALFOUR-BABY Bauchdeckenhalter	415
BALL & SOCKET Tuchklemmen	291
BALLENGER Schwammzangen	293
BALLENGER Tonsillenfasszange	238
BANDIT-LEKSELL Hohlmeißelzangen	580
Bariatrische Chirurgie	563-580
Bariatrische Chirurgie- Pinzetten	144, 566
BARON Spülkanülen	535
BARR Analspreizer	463
BARRAQUER Cilienpinzette	163
BARRAQUER Fadenpinzette	199
BARRAQUER Fixierpinzette	196
BARRAQUER Hornhautscheren	71
BARRAQUER Iridektomiescheren	71
BARRAQUER Klängenbrecher	64
BARRAQUER Lidperrer	388
BARRAQUER Nadelhalter	472,473
BARRAQUER Nahtpinzetten	194
BARRAQUER Vorderkammerpinzetten	202
BARRAQUER-COLIBRI Fixierpinzette	194
BARRAQUER-KATZIN Fixierpinzette	194
BARRAQUER-TROUTMAN Nadelhalter	472
BARRET Hakenzange	276
BARRON Skalpellgriff	54
BARSKY Hauthäkchen	307
Batteriegriff für Laryngoskope	38,40
Bauch- und Darmspateln	354-357
Bauchdeckenhalter	411-429,439-441
Bauchdeckenhalter röntgenfähig	425
Bauchdeckenspekulum	424
Bauchspateln	354,355
BAUER intraorale Retraktoren	378
BAUMGARTNER Nadelhalter	588,501
BECKMAN Wundspreizer	403
BECKMAN-ADSON Wundspreizer	404
BECKMAN-EATON Wundspreizer	403
BECKMANN-WEITLANER Wundspreizer	402
BEEBEE Drahtscheren	117
BEER Cilienpinzette	163
BEESON Gipsspreizer	557
Beinhautmesser	60
BENGOLEA Arterienklemmen	226
Bereitschaftskoffer für Gipssägen	560
BERENS Muskelklemme	205
BERGH Cilienpinzette	163
BERGMANN Gipssäge	556
BERGMANN Verbandschere	136

	Seite		Seite
BERGMANN Wundhaken	315	BUNT Sterilisierklammer	299
BERGMANN-FOERSTER Schwammzangen	293	Bürsten, Handwasch-	30
BERKE Muskelpinzetten	205	Bürstenspender	30
BERLINER Reflexhammer	16	BUSCH Nabelschnurschere 16 cm	116
BERNHARD Tuchklemmen	291		
BERRY Sternal-Nadelhalter	492	C	
BERTILLON Schädel-Messzirkel	23	CANNY-RYALL Wundhaken	329
BEST Darmklemmen	253	CAPLAN Nasenschere	122
BIEMER Venenschere	83,88	CARMALT Splitterpinzetten	161
Bindehautpinzetten	193	CARREL Arterienklemme	220
Biopsiekanülen	546	CARROL Finger-Goniometer	22
Bipolare Koagulationspinzetten	167-171	CASPAR Bohrer	453
BIPOL-Kabel für Bipolpinzetten	172	CASPAR Bohrlehren	451,452
BIRKETT Arterienklemmen	238	CASPAR Cervicalsperrerr	447
BISHOP-HARMAN Irispinzetten	192	CASPAR Distractionsschrauben	453
BLAKE Gallensteinzangen	264	CASPAR Gegensperrerr	447,449
BLANK antraumatische Pinzetten	144	CASPAR Schraubendreher	453
BLASCOVICS Muskelpinzetten	205,285	CASPAR Spekula	449
Blasensprenger	285	CASPAR Spekula für trans-sphenoidale Hypophysektomie	450
Blasen-Wundspreizer	464-465	CASPAR Spreizer für lumbale Wirbelsäule	446
BLESSING Schere für Rektum PROMEDUR	127	CASPAR Valven (Gegensperrerr) 35 mm	450
BLOHMKE Tonsillenfasszange	238	CASPAR Wirbelkörper Distraktor	451,452
BLOUNT Knochenhebel/Kniewundhaken	370	CASPAR Wirbelkörperspreizer	445
Blutdruckmesser	8 - 10	CASPAR Wundhaken	340
BOETTCHER Tonsillenschere	122	CASTROVIEJO Federscheren	74
BONACCOLTO Nahtpinzette	200	CASTROVIEJO Fixierpinzetten	197
BONACCOLTO Strabismuspinzetten	203	CASTROVIEJO Hornhautscheren	72
BONN Fadenpinzette	198	CASTROVIEJO Iridektomieschere	72
BONN Irispinzetten	193	CASTROVIEJO Kapselpinzette	201
BONN Irisscheren	67	CASTROVIEJO Klängenbrecher	64
BONN Irisscheren SUPERCUT	67	CASTROVIEJO Nadelhalter	470
BONN Mikrohäkchen	303	CASTROVIEJO Nahtpinzetten	198
BONN Strabismusscheren	67	CASTROVIEJO Sperrelevator	389
BONN Strabismusscheren SUPERCUT	67	CASTROVIEJO Synechie-Schere	72
BONNEY anatomische Pinzetten	145,165	CASTROVIEJO Tränenkanal-Sonde	521
BONNEY chirurgische Pinzetten	153,166	CASTROVIEJO Zirkel	23
BOROWSKI Atriumhaken	382	CASTROVIEJO-MICRO Nadelhalter	473
BOSE Trachealdilatator	391	CATLIN Amputationsmesser	59
BOWMAN Gefäßschere	107	Chalazionspinzetten	204-207
BOWMAN Sperrelevator	388	CHAPUT Arterienklemme	243
BOWMAN Tränenkanalsonden	520	CHARNLEY Horizontalspreizer	401
BOYNTON Nadelhalter	470	CHARNLEY Wundspreizer	429
BOYS-ALLIS Gewebefäßzange	244	CHEATLE Sterilisierzangen	298
BOZEMANN Nadelhalter	493	CHERON Schwammzangen	297
BOZEMANN Schwammzangen	297	CHILDE Klammerpinzetten	506
BOZEMANN Uterusschere	115	chirurgische Pinzetten	148-155
BOZEMANN-DOUGLAS Schwammzangen	297	chirurgische Pinzetten PROMEDUR	164-165
BRAUN Hakenzangen	276	chirurgische Pinzetten USA-Model	150
BRAUN-STADLER Episiotomieschere	115	chirurgische Pinzetten, fein	150
BRIDGE Arterienklemmen	227	chirurgische Pinzetten, TITAN	148-149,151,153
BROM Venenhaken	315	chirurgische Scheren	93,94,96,125
BROMPTON Schlauchroller	292	chirurgische Scheren PROMEDUR	125
Bronchus, Ligatur- und Lungenfaßzangen	239-242	chirurgische Scheren PROMEDUR	125
Bronchusklemmen	239,240,241,572	Cilienpinzetten	163
BROPHY anatomische Pinzetten	144	CLAR Stirnlampen	20
BROPHY chirurgische Pinzetten	151	CLARKE Sperrelevator	388
BROPHY feine Präparierscheren	121	Clips, Mikro	210
BROWN chirurgische Pinzetten	154	CLOWARD Durahäkchen	311
BRUNETTI Meißel z. Öffnen der Wirbelsäule	587	CLOWARD Wirbelkörperspreizer	430,431,443
BRUNNER Darmklemme	253	CLOWARD Wundhaken	309
BRUNNER Führungshohlsonden	517	CLOWARD-CONTOUR Wundspreizer	400
BRUNNER Umführungsadeln	515	CLOWARD-HOEN Wirbelkörperspreizer	432
BRUNNER Wundhaken	351,352	COAKLEY Oberkiefertrokar	542
BRUNNER-FERROZELL Führungshohlsonden	517	COBBETT Dermatome	63
BRUNS Gipsscheren	138	COHAN Nadelhalter	472
Brustfell-Biopsienadeln	546	COHAN-VANNAS Irisscheren	74
BRYANT Tupferzange	295	COHEN Nagelhautzängchen	29
BÜCHS Wangenhaken	375	COLLER-CRILE Arterienklemmen	224
BUCK Fadenschere	117	COLLIER Nadelhalter	501
BUCK Reflexhammer	16	COLLIN Bauchdeckenhalter	411
BUIE Druckklemme	261	COLLIN Beckenzirkel	25
BUIE Fistelsonde	526	COLLIN Dynamometer	17
Bulldogklemmen	210-220	COLLIN Gewebefäßklemme	247
Bulldogklemmen, atraumatisch	212-219	COLLIN Klammerzängchen	507
BUMM Uterus-Polypenzange	286		

	Seite		Seite
COLLIN Kornzangen	297	DAVIS Hirnspateln	459
COLLIN Skalpellgriffe	53, 55	DAVIS Sterilisierpinzetten	298
COLLIN Uterusfasszangen	282	DAY Ohrhäkchen	305
COLLIN Wundhaken	329	DEAN Tonsillenscheren	122
COLLIN Zungenzange	36	DEAN Tonsillenscheren PROMEDUR	134
COLLIN-BABY Bauchdeckenhalter	411	DEAVER Scheren	94
COLLIN-DUVAL Faßpinzetten	156	DEAVER Wundhaken	357-359
COLLIN-HARTMANN Wundhaken	330	DEBAKEY Absaugrohre	538
COLLIN-LOCKTITE Bauchdeckenhalter	412	DEBAKEY atraumatische Pinzetten	157,567
COLLYER Beckenzirkel	25	DEBAKEY atraumatische Pinzetten TITAN	157-158
Columnella-Pinzette	190	DEBAKEY Bulldogklemmen	217,218
COLVER Tonsillenfasszangen	238	DEBAKEY chirurgische Pinzetten PROMEDUR	165
CONE Hemilaminektomiespreizer	397	DEBAKEY Femur-Wundsperrer	407
Container für Endoskopie-Instrumente	600	DEBAKEY Gefäßdilatatoren	525
Container, Sterilisier-	592-601,607	DEBAKEY Gefäßscheren	109,133
CONVERSE Nasenretractor	308	DEBAKEY Gewebe-u.Organfaßzangen	248
CONVERSE-ALAR Häkchen	308	DEBAKEY Nadelhalter	490,576
COOK Sperrelevatoren	390	DEBAKEY Präparierscheren	104
COOLEY atraumatische Pinzetten	158	DEBAKEY-GERALD Pinzetten	145
COOLEY atraumatische Pinzetten TITAN	158	DEBAKEY-Heparin Kanülen	547
COOLEY Atriumhaken	383	DEBAKEY-MICRO Bulldogklemmen	217
COOLEY Saugrohre	539,578	DEBAKEY-Mikropinzetten mir Rundgriff	185
COOPER Unterbindungsnadel	515	DEBAKEY-Mikropinzetten mir Rundgriff TITAN	185
COPE Wundhaken	322	DEBAKEY-SATINSKY Bulldogklemmen	219
CORN Fadenpinzette	507	DEBAKEY-SELECT Nadelhalter	491
COTTLE (Millard) Fingerringhäkchen	308	DEBAKEY-SELECT Nadelhalter DIAMANT	491
COTTLE Alar Häkchen	308	Deckglaspinzetten	162
COTTLE Columnella Pinzette	190	DEJERINE Reflexhämmer	16
COTTLE Fixierpinzette	190	Dekompressionshaken	314
COTTLE Nasenflügelretractor	307	DEMARTEL Gefäßscheren	110
COTTLE Nasenhäkchen	306	DENIS-BROWN Bauchdeckenhalter	418
COTTLE Wundhaken	307	DENIS-BROWN Darmfaßpinzette	156
COTTLE-BULLDOG Nasenschere	118	Dental-Container	601
COTTLE-DORSAL Nasenschere	118	DERF Nadelhalter	488,501
COTTLE-MASING Nasenscheren	119	Dermatome	62,63
COUPLAND Saugrohr	537	DERMOT-PIERSE Fixierpinzetten	195
COX Finger- und Zehenspreizer	393	D'ERRICO Nervwurzelhaken	314
CRAFOORD Arterienklemmen	229	DESCHAMPS Unterbindungsnadeln	514
CRAFOORD Lungenscheren	107	DESJARDINS Gallenkanalklemmen	262
CRAFOORD-SELLORS Arterienklemmen	229	DESJARDINS Gallensteinsonden	527
CRAWFORD Wundhaken	384	DESJARDINS Gallensteinzangen	264
CRILE Arterienklemmen	222	DESMARRES Chalazionspinzetten	206
CRILE Arterienklemmen TITAN	222	DESMARRES Lidhalter	304
CRILE Nadelhalter	502	Diagnostik	7 - 20
CRILE Nervhäkchen	309	DICK Klemmzangen atraumatisch	271
CRILE-BABY Arterienklemmen	222	DIEFFENBACH Bulldogklemmen	210
CRILE-MURRAY	502	DIETHRICH Nadelhalter	500
CRILE-WOOD Nadelhalter	489,502	DIETRICH Bulldogklemmen	214
CRILE-WOOD Nadelhalter für Linkshänder	489	DINGMAN Jochbogen-Haken	381
CRITCHETT Sperrelevator	388	DOCKHORN Wangenhaken	373
CUSHING anatomische Pinzetten	145,164	Doppelkrallen	303
CUSHING Dekompressionshaken	314	DOUGLAS Cilienpinzetten	163
CUSHING Durahäkchen	311	DOUGLAS Kieferhöhlentroker	542
CUSHING Nervhaken	310	DOYEN Bauchdeckenhalter	424
CUSHING Spateln	460	DOYEN Darmklemmen	249
CUSHING Venenhaken	324,326,574	DOYEN Hohlsonde	523
CZERNY Hakenzange	276	DOYEN Nadelhalter	501
CZERNY Wundhaken	331	DOYEN Polypenzange	265
		DOYEN Schere	115
		DOYEN Tuchklemmen	290
		DOYEN Uterus-Polypenzange	285
		DOYEN Wundhaken	345
		DOYEN-DEBAKEY Darmklemmen	255
		DOYEN-STILLE Wundhaken	345
		Drahtscheren	147,134
		DREIRING-Spritzen	549
		Druckklemmen	261,271
		DUBOIS Kephalotomiescheren	116
		DUEHRSEN anatomische Pinzetten	145
		DUEHRSEN chirurgische Pinzetten	152
		DUNHILL Arterienklemmen	222
		DUPLAY Hakenzange	278
		DUPLAY Kornzangen	296
		DUPLEX Stethoskope	18
		DURANTE chirurgische Pinzetten	155

D

DALE Hohlmeißelzange	580
DANDY Arterienklemmen	223
DANDY Duraschere	111
DANDY Nervhaken	310
DANDY-MOSQUITO Arterienklemmen	223
DARLING Wundspreizer	407
Darmfaßpinzetten	156
Darmklemmen	249-260
Darmklemmen, atraumatisch	255-260
Darmklemmen, elastisch	250-251
Darmscheren	112
DARTIGUES Uterusfasszange	283
DASTOOR Strabismuspinzetten	203
DAVIDSON Scapula-Haken	364

	Seite		Seite
Durascheren	111	Fixierpinzetten	195-197
DUVAL atraumatische Gewebefaßklemmen	247	Flach-Sterilisiercontainer	598
DUVAL Darmfaßpinzette	156	FLAGG Zahnpinzetten	174
DUVAL Gewebefaßklemmen	247	FLETCHER Schwammzangen	294
DUVAL Gewebefaßklemmen PROMEDUR	247	FOERSTER Bauchdhalter röntgenfähig	425
Dynamometer	17	FOERSTER Irispinzetten	192
E		FOERSTER Schwammzangen	293,573
EICKEN-KILLIAN Spülkanülen	535	FOMON Nasenflügelschere	118,119
Einschlagtücher	604	FOMON Nasenhäkchen	307
EISELSBERG Ligaturschere	117	FOMON-DORSAL Nasenschere	118
ELSCHNIG Fixierpinzette	196	FOSTER-GILLIES Nadelhalter	497
ELSCHNIG Kapselpinzette	201	FOSTER-GILLIES Nadelhalter für Linkshänder	497
EMMET Fistelhaken	327	FOX Hautküretten	32
EMMET Korn- u. Tupferzangen	296	FRANKLIN-SILVERMAN Biopsiekanülen	546
Endoskopie-Contaiern	600	FRAZIER Durahäkchen	311
Endospekula	466	FRAZIER Punktionskanülen	531
Endospekula	466	FRAZIER Saugkanülen	533
ENGEL Gipssäge	556	FRAZIER Saugkanülen isoliert	533
Entropiumpinzetten	204	FREER Schleimhauthaken	306
Enukleationsscheren	69	Fremdkörperpinzetten	163
EPICARDIAL Spreizer TITAN	392	FRITSCH Wundhaken	347
Episiotomiescheren	115,116	FUCHS Kapselpinzette	201
EPISKLERAL Fixierpinzette	197	FUCHSIG Arterienklemmen	226
ERHARDT Entropiumpinzette	204	Führungshohlsonden	516-517
ESMARCH Gipsmesser	556	Führungsnadeln für Saugdrainage	540
ESMARCH Gipsscheren	136	FUKUSHIMA Saugkanülen	530
EWALD anatomische Pinzette	142	G	
EWALD chirurgische Pinzetten	148	Gallenkanaldilatatoren	528
EXACTA Blutdruckmesser	9	Gallenkanalklemmen	262-263
Extraorale Retraktoren mit und ohne Kaltlicht	380,381	Gallsteinzangen	264-265
F		GARRETT Gefäßdilatoren	525
Fadengabel	517	GAUSS Kopfschwartzange	284
Fadenpinzetten	507	Gefäßdilatoren	525
Fadenscheren	117	Gefäßhäkchen	315
FARABEUF Wundhaken	328	Gefäßscheren	107-110,315
FARRELL Watteträger	529	Gefäßscheren geknüpft	107
Faßpinzetten	156,195-197	Gefäßscheren PROMEDUR	133,134
FAURE Peritoneumklemmen	270	Gefäß-Spülkanülen	536
FAVOLORO Gefäßscheren	109	Gefäßwundspreizer	409
FEDERLEICHT Bulldogklemmen	215	GELPI Wundspreizer	408
FEHLAND Darmklemme	253	GELPI-BABY Wundspreizer	408
FEHLAND-DEBAKEY Darmklemmen	257	GELPI-MINI Wundspreizer	408
FEILCHENFELD Splitterpinzetten	161	GELPI-ORTHO Wundspreizer	409
feine anatomische Pinzetten	140 - 143,0145-146	GELPI-SELETZ Wundspreizer	409
feine anatomische Pinzetten PROMEDUR	164	GEMINI Arterienklemmen	234,571
feine chirurgische Pinzetten	140 - 143,0145-146,150	GEMINI-MINI Arterienklemmen	234
feine chirurgische Scheren	93-95	GERALD anatomische Pinzetten	145
feine Wundhäkchen	303-308, 316-323	GERALD anatomische Pinzetten TITAN	145
FELDHEIM Kompressorium	32	GERALD chirurgische Pinzetten	151
FERGUSON Gynäkologische Schere	115	GERALD chirurgische Pinzetten PROMEDUR	165
FERGUSON Saugkanülen	533	GERALD chirurgische Pinzetten TITAN	151
FERGUSON Saugkanülen isoliert	533	GEUDEL-NEGUS Laryngoskope	42
FERGUSSON Druckklemmen	261	Gewebe- und Organfaßzangen	243-248
FERRIS-SMITH chirurgische Pinzetten	151	GILL Irispinzette	193
FERROZELL Führungshohlsonden	517	GILL-HESS Irispinzetten	193
Filter für Steri-Container	603,604	GILLIES chirurgische Pinzetten	149
Filterhalter	603	GILLIES chirurgische Pinzetten TITAN	149
Filterset für Gipssäge	559	GILLIES chirurgische Pinzetten PROMEDUR	165
Filterspender	603	GILLIES Hauthäkchen	31,315
Fingerringsägen	34	GILLIES Nadelhalter	498,505
Fingerspreizer	393	GILLIES-MINI Nadelhalter	498,505
FINK Hauthäkchen	302	GIL-VERNET Venen- und Hilushaken	325
FINOCCHIETTO Bronchusklemme	239	Gipsabreisszangen	557
FINOCHIETTO Nadelhalter	493,503	Gipsmesser	556
FINSEN Wundspreizer	391	Gipssägen, elektrisch	558-560
FISCH Spülkanülen	531	Gipssägen, manuell	556
FISH Sonden	524	Gipsscheren	136-139
FISHER-ARLT Irispinzette	191	Gipsspreizer	557
Fistelscheren	95	GLASSMANN atraumatische Pinzetten	159
Fistelsonden	523	GLOVER Bulldogklemmen	212
Fixierfedern	605	GOELET Wundhaken	331
Fixierklammern für Tücher	605	GOLDMAN-FOX Ligaturscheren	105
		GOLDMAN-FOX Ligaturscheren PROMEDUR	124

	Seite		Seite
GOLDMAN-FOX Zahnfleischscheren SUPERCUT	105	HEIFETZ Hirnspateln	456,459
GOLDSTEIN Tränen sack Wund spreizer	390	HEIFETZ Tumorpinzetten	179
Goniometer	22	HEIFETZ-Ringpinzetten mit Profilgriff	187
GOOD Tonsillens chere	122	HEISS Arterienklemmen	226
GORNEY (Killian) Nasens chere	122	Hemilaminektomie-Spreizer	396,397
GORNEY Präparierscheren	106	HENLEY Wund spreizer	410
GORNEY Saugdissektor	536	HENNING Gips spreizer	557
GOSSET Bauchdeckenhalter	414	HENROTIN Hakenzange	280
GRADLE Fadenscheren	117	HENRY Cilienpinzette	163
GRAEFE Augens chere	68	Heparin Kanülen	547
GRAEFE chirurgische Irispinzetten	147	HERMANN Gips spreizer	557
GRAEFE Fixierpinzetten	196	HERRICK Nierenstielklemmen	266
GRAEFE Irishäkchen	302	HERTZLER Bauchdeckenhalter	415
GRAEFE Irispinzetten	140	HESS Irispinzetten	194
GRAEFE Irispinzetten TITAN	140,147,191	HESS Kapselpinzetten	201
GRAEFE Mikrohäkchen	303	HEYMANN Nasens chere	118
GRAEFE Schielhaken	304	HEYWOOD-SMITH Uterus-Polypenzangen	285
GRAEFE Sperrelevatoren	388	HIBBS Valven	438
GRAEFE-SELECT Irispinzetten	140,147,191	HIBBS Wundhaken	362
GRAHAM Nervhaken	309	Hirnmesser	60
GRAY Gallenkanalklemmen	263	Hirns pateln	459,460
GRAZIL chirurgische Scheren	96	HNO Diagnostikbestecke	11 - 15
GREEN Fixierpinzetten	196	HOEN chirurgische Pinzette	175
GREEN Schielhaken	304	HOEN Nervhaken	309
GREEN Wundhaken	343	HOEN Wirbelkörperspreizer	432
GREEN-ARMYTAGE Abortuszangen	284	Hohlmeisselzangen für bariatrische Chirurgie	580
GREGORY Bulldogklemmen	213	Hohlsonden	523
GREGORY Nadelhalter	482	Hohlsonden geknöpft	523
GROSS Kornzangen	296	HOLSCHER Nervwurzelhaken	313
GRUENWALD (Jansen) Pinzetten	190	HOLTZHEIMER Wund spreizer	392
GRUENWALD Pinzetten	190	HOLZBACH Bauchdeckenhalter	413
GUILLEN Saugraspatorium	535	HOPKINS Gipsmesser	556
GUILFORD Drahtschere	117	HORGAN Mittelvalven	417
GUNNAR-HEY Schlauchroller	292	Horizontalspreizer	401
GUTHRIE Fixier-Doppelhäkchen	302	HÖSEL Nadelhalter	497
GUYON Nierenstielklemmen	266,571	HÖSEL Wundhaken	346
Gynäkologische Scheren	114,115	HOUSE Spülkanülen	531
		HRYNTSCHAK Blasenwund spreizer	465
		Hüftgelenkhaken	340
		HULKA Hakenzange	278
		HULKA-KENWICK Hakenzange	278
		HUMBY Dermatom	63
		HUNT Tumorpinzette	179
		HUNTER Splitterpinzetten	161
		Hypopysektomiescheren	90
		Hysterektomie klemmen	272-275
H		I	
HABERER Bauchspateln	355	I.M.A Mammaria Spreizer	461
Häkchen für Gynäkologie	327	Indikator-Schilder	602
Häkchen für Rhinologie	306-308	ILIC Weichgewebebezüge	29
Häkchen für Urologie	327	INFANT Tränenkanaldilatator	521
Hakenzangen	276-281	Infusionsflaschen-Öffnungszange	299
HALSEY Nadelhalter	488,501	INGE Lamina Spreizer	444
HALSEY-MICRO Nadelhalter	488	INGE-BABY Lamina Spreizer	443
HALSTED Arterienklemmen	225	Instrumentenbügel	299
HALSTED-MOSQUITO Arterienklemmen	221	Instrumentenkästen	612
Haltestift für Instrumente	606	Instrumentenklammern	299
Haltestift für Trennbleche	606	Instrumentenöl	608
Handwaschbürsten sterilisierbar	30	Instrumentenschalen	612
HARMS Trabekularsonden	521	Insufflationskanülen	547
HARRINGTON Bronchusklemmen	239,572	INTRACARDIAC Nadelhalter	492
HARRINGTON Wundhaken	361	Intraorale Retraktoren	378-379
HARRISON Sterilisierzangen	298	Inzisions-Scheren	95
HARTMANN Arterienklemmen	220	IOWA Blasensprenger	285
HARTMANN Ligaturklemme	220	Irispinzetten	140,191-193
HARTMANN Spülkanülen	535	Irispinzetten TITAN	140
HARTMANN-MIKRO Arterienklemmen	220	Irisscheren	91,92,124
HARVEY Drahtschere	117	Irisscheren delikat	68
HARVEY-JACKSON Wund spreizer	405	Irisscheren für Linkshänder	91
Hauthäkchen	31,305, 315	Irisscheren PROMEDUR	124
Hautküretten	32	Irisscheren SUPERCUT	91
Hauttrephinen	32	ISRAEL Wundhaken	337
HAYES-DEBAKEY Darmklemmen	257		
HEANEY Hysterektomie klemmen	272		
HEANEY Nadelhalter	494,504		
HEANEY Wundhaken	362		
HEANEY-KANTER Hysterektomie klemmen	272		
HEANEY-REZAK Hysterektomie klemme	272		
HEATH (Hunt) Chalazionspinzette	207		
HEGEMANN Gefäßscheren	108		
HEGEMANN-DIETHRICH Gefäßscheren	108		
HEGENBARTH Klammerpinzette	506		

	Seite		Seite
J			
JACKSON Trachealhäkchen	322	KIRKLIN Venenhäkchen	324
JACKSON-BURROWS Wundspreizer	409	KIRSCH Wangenhaken	373
JACOBS Hakenzangen	280	KIRSCHNER Bauchdeckenhalter	419,420
JACOBSON MIKRO-Nadelhalter	481	KIRSTEIN (Heymann) Nasenschere	118
JACOBSON Mikro-Scheren	82	KLAPP Sehnenscheidenhaken	320
JACOBSON-ADSON Pinzetten	176	Kleiderscheren	136
JACOBSON-MIKRO Arterienklemmen	221	KLEINERT-KUTZ Wund- u. Hauthäkchen,	31,315
JACOBSON-MIKRO Pinzetten	176	Klemm-, Plazentar-, und Abortuszangen	271,284-287
JAEGER Schielhaken	304	Klemmzangen atraumatisch	271
JAMESON Präparierscheren	104	KLIMA-ROSEGGER Sternal-Punktionsnadel	545
JAMESON Präparierscheren SUPERCUT	104	KLINGENBERG-LOTH Präparierscheren	107
JAMESON Muskelpinzetten	204	Klingenbrecher	64
JAMESON Schieblehre	24	Klingenentferner	50
JAMESON Schielhaken	304	Klingenthaler	50-56
JAMESON-WERBER Präparierschere	104	KLING-EX Klingentferner	50
JANET Spritzen	550	KLINIKUM BERLIN Schlauchklemme	292
JANSEN Wundspreizer	392	KNAPP Irisscheren	67
JEFFERSON anatomische Pinzette	143	KNAPP Trachompinzette	204
JEFFERSON chirurgische Pinzetten	149	KNAPP Tränensackhäkchen	302
JOBSON-HORNE Watteträger 18 cm	529	Kniegelenkshaken	370
Jochbogen-Haken	381	Knochenhaken	335,368-370
JOHN-HOPKINS Anlegezange	210	Knochenmesszange mitSkala	23
JOHN-HOPKINS Bulldogklemmen	210	Knopfsonden	522,577
JOHN-HOPKINS Gallenkanalklemmen	263	Knopfsonden für bariatrische Chirurgie	577
JOHNSON Nadelhalter	503	Knorpelmesser	60
JOLL (Friedmann) Wundspreizer	407	Knorpelscheren	123
JONES Tuchklemmen	290	KNOWLES Verbandschere	135
JÖRGENSON Präparierschere	99	Knüpfpinzetten	161
JOSEPH feine Präparierscheren	121	Knüpfpinzetten, Mikro-	176,180,182,183
JOSEPH Nasenhäkchen	306	Koagulationspinzetten, bipolar	167-171
JUDD-ALLIS Gewebefaßklemmen	244	KOCHER Arterienklemmen	231
JUDD-MASON Blasenwundspreizer	464	KOCHER Darmklemmen	250
JUDD-MASON Wundspreizer	465	KOCHER Wundhaken	334,338,341,342
JULIAN Nadelhalter	491	KOCHER-BABY Darmklemmen	249
Juwelierpinzetten	141	KOCHER-DEBAKEY Darmklemmen	256
K			
Kabel für Bipolpinzetten	172	KOCHER-GRAZIL Arterienklemmen	231
KADER Bauchspatel	354	KOCHER-LANGENBECK Wundhaken	338
KALT Kapselpinzette	201	KOCHER-WAGNER Wundhaken	347
KALT Nadelhalter	471	KOERTE Spateln	356
KALT-ARRUGA Nadelhalter	471	KOERTE Wundhaken	336
Kaltlichtgriff für Laryngoskope	44,46	KOGAN Endospekula	466
KANTROWITZ Arterienklemmen	234	Komedonenquetscher	31
Kappenzangen	610	KÖNIG Nagelspaltscheren	33
Kapselpinzetten	201	KÖNIG Wundhaken	320
Kapselschere	123	KONRICH Sterilisiertrommeln	607
Katheterzangen	36	Kopfschwartenzangen	284
KATSCH Komendonoinstr	31	Kornzangen	295-297
KATZIN Hornhautscheren	73	Koronarscheren mit Flachgriff	80
KATZIN-BARRAQUER Keratoplastikscheren	73	Koronarscheren mit Flachgriff TITAN	80
KAYE Nadelhalter	498,499	Koronarscheren mit Rundgriff	81
KAYE Transplantatationsscheren	120	Koronarscheren mit Rundgriff TITAN	81
Kehlkopfkanüle	549	KRAUSE Kieferhöhlentroker	542
KELLY Abortuszange	287	KRONECKER Unterbindungsnadeln	515
KELLY Arterienklemmen	222,230	Kropfwundhaken	337
KELLY Arterienklemmen TITAN	222	KUEHNE Deckglaspinzetten	162
KELLY Fistelscheren	95	KÜMMEL Spateln	356
KELLY Gefäßscheren PROMEDUR	134	KÜSTNER Hakenzange	281
KELLY Wundhaken	343,344	L	
KELMAN-McPHERSON Fadenpinzette	199	LA GRANGE Sklerektomiescheren	69
Kennzeichnungsschilder für Steri-Container	602	LAHEY Durahäkchen	311
Kephalotomiescheren	116	LAHEY Gallenkanalklemmen	262
KERSTING atraumatische Darmklemme	258	LAHEY Kropfwundhaken	337
KEYES Hautrephinen	32	LAHEY-METZENBAUM Präparierscheren	101
Kiefer- und Gesichtschirurgiehaken	371-381	LAMBERT Chalazionspinzette	206
KILLIAN Spülkanüle	535	LAMBOTTE Knochenhaken	368
KILNER (Ragnell) feine Präparierscheren	120	Laminektomie-Spreizer	434-438,442-453
KILNER feine Präparierscheren	119	Laminektomie-Wundspreizer	401-405,434-438
KILNER Hauthäkchen	31,315	LANCASTER Sperrelevator	389
KILNER Nadelhalter	488,501	LANDAU Trokar	542
KILNER Nasenfluegelretractor	308	LANDOLD Klingehalter	51
Kinnhalter	377	LANE chirurgische Pinzetten	154
		LANE Knochenhebel	368
		LANE Magenklemmen	254

	Seite		Seite
LANE Tuchklemmen	291	MAGILL Katheterzangen	36
LANE-TRETHOWAN Knochenhebel	368	MAIER Kornzangen	296
LANGE Choanenhaken	307	MALTZ Wundhaken	307
LANGENBECK Amputationsmesser	59	MANNERFELT Sattelhaken	317
LANGENBECK Hüftgelenkhaken	340	MANNERFELT Wundhaken	316,317
LANGENBECK Nadelhalter	493	MANNERFELT-LANGENBECK Wundhaken	317
LANGENBECK Resektionsmesser	60	MARBERGER Venenhaken	325
LANGENBECK Wundhaken	339,340	MARINUS Darmklemmen	260
LANGENBECK-MINI Wundhaken	323	MARKHAM-MEYERDING Wundspreizer	406
Laryngoskope	37-46	MARSCHIK Tonsillenfasspinzette	238
LATERAL-Retraktor	466	MARTEL Kopfschwartzange	284
LAWRENCE Arterienklemmen	235	MARTIN Abfallzange	298
LAZAR Mikro-Knüpfpinzette 185 mm/0,5mm	160	MARTIN Beckenzirkel	25
Leberpunktionskanülen	545	MARTIN Haken/Scheidenhalter	348
LEGUEU Blasen-Wundspreizer	412	MARTIN Knorpelschere	123
LEMPERT Nagelhautzängchen	29	Massbänder	22
LERCHE chirurgische Pinzetten	153	MASSON Nadelhalter	494,504
LERICHE Arterienklemmen	223	Massstäbe	22
LERICHE Spateln	356	MATHIEU Nadelhalter	496,505
LERMOYEZ Trokare	542	MATHIEU Rektalspekulum	462
LESTER Fixierpinzetten	196	MATHIEU Wundhaken 16 cm stumpf	321,330
LeVASSEUR-MERRILL Retraktoren	381	MATHIEU-KOCHER Nadelhalter	496
LEXER-BABY Präparierscheren	100	MAYO Instrumentenklammern	299
LEXER-BABY Scheren PROMEDUR	124	MAYO Präparierscheren	98
LEYLA Ohrspekulahalter	456	MAYO Präparierscheren PROMEDUR	125, 565
LEYLA Ohrtrichterhalter	456	MAYO Scheren SUPERCUT	98
LEYLA Retraktor System	455-458	MAYO-ADAMS Bauchdeckenhalter	412
LICHTENBERG Nadelhalter	496	MAYO-BLAKE Gallensteinzangen	265
LICHTWITZ Trokar	541	MAYO-GUYON Nierenklemmen	266
Lidhäkchen	304	MAYO-HARRINGTON Präparierscheren	99
Lidhalter	304	MAYO-HARRINGTON Präparierscheren PROMEDUR	126
Lidsperre	388-391	MAYO-HEGAR Nadelhalter	490,502,577
LIEBERMANN Sperrelevatoren	390	MAYO-HEGAR Nadelhalter für bariatrische Chirurgie	502,576
Ligaturklemmen	220	MAYO-HEGAR Nadelhalter für Linkshänder	490
Ligaturscheren PROMEDUR	134	MAYO-LEXER Präparierscheren	99,126
Linkshänder Metzenbaum-Schere	101	MAYO-NOBLE Präparierscheren	99
Linkshänder Nadelhalter	488,489,490,497,498,505	MAYO-ROBSON Darmklemmen	251
Linkshänder Scheren	91,97101,120,135	MAYO-RUSSIAN chirurgische Pinzetten	154
LISTER Verbandscheren	135	MAYO-STILLE Präparierscheren	98,125
LISTER Verbandscheren für Linkshänder	135	MAYO-STILLE Präparierscheren PROMEDUR	125
LISTER-BURCH Sperrelevator	389	McCOLLOUGH Strabismuspinzetten	202
LISTER-EXCENTRIC Verbandscheren	135	McGUIRE Hornhautscheren	67
LISTER-SINUS Tupferzangen	295	McINDOE anatomische Pinzetten	143
LISTON Amputationsmesser	59	McINDOE anatomische Pinzetten PROMEDUR	165
LITTAUER Cilienpinzette	163	McINDOE anatomische Pinzetten TITAN	143
LITTAUER Fadenschere	117	McINDOE Schere für plastische Chirurgie	122
LITTAUER Nagelspaltzangen	28	McINTOSH Laryngoskope	37-38, 43-44
LITTLE Wundhaken	337	McPHERSON Fadenpinzetten	199
LITTLEWOOD Gewebefaßklemme	244	Medizinbecher	611
LLOYD-DAVIS Rektum-Anastomosenklemme	261	Medizinlöffel	611
LLOYD-DAVIS Rektumschere	113	MEEKER Arterienklemmen	235
LOCKHART-MUMMERY Fistelsonden	523	Mehrzweckhaken	381
LOCKLIN Zahnfleischscheren	106	MELLINGER Sperrelevatoren	389
LOCKLIN Zahnfleischscheren PROMEDUR	134	MELLINGER-AXENFELD Sperrelevatoren	389
LOCKWOOD Gewebefaßklemmen	245	MEMORY Hirnspateln	460
LONDON-COLLEGE Zahnpinzetten	173	MENGHINI Leberpunktionskanülen	545
LORDAN Chalazionspinzette	207	Meniskushaken	370
LORENZ Verbandschere	135	MERIAM Zahnpinzetten	174
LORNA (Edna) Tuchklemmen	291	Messbecher	609
LOVE Nervwurzelhaken	312	Metall Massstäbe	22
LOVELACE Arterienklemmen	223	METZENBAUM Nadelhalter	503
LOVELACE Lungenklemmen	241	METZENBAUM Präparierscheren	101-103,564
LOWER Gallenkanalklemmen	263	METZENBAUM Präparierscheren f. Linkshänder	101
LUCAE Ohrhäkchen	305	METZENBAUM Präparierscheren PROMEDUR	128-132,565
LUCAE Ohrpinzetten	189	METZENBAUM-BABY Präparierscheren	100
LUKENS Thymus-Haken	322	METZENBAUM-BABY Präparierscheren SUPERCUT	100
Lumbal-Punktionskanülen	545	METZENBAUM-FINO Präparierscheren	103
Lungenscheren	100,107,564	METZENBAUM-LAHEY Präparierscheren	101
Lungenspatenl	361,363,365,366	MEYERDING Walven	438
Lupenbrillen	19	MEYERDING Wundhaken	319,348
LURZ Ureterklemmen	269	MEYERDING Wundspreizer	406
		MEYER-SCHWICKERATH Lokalisator	302
		MICHEL Klammerzängchen	506
		MICHEL Wundklammern	507
		MICHEL Wundklammerpinzetten	506
M			
MAGILL Absaugrohre	536		

	Seite		Seite
MICHEL Wundnahtbesteck	508	MUELLER Sperrelevator	389
MICHEL-FINO Klammerzangchen	506	MULDOON Tranenkanaldilatatoren	521
Microclip-Anlegezangen	210	Mundwinkelhalter	373
MICRO-MOSQUITO Arterienklemmen	221	MURDOCK Sperrelevator	388
Micro-Vascular Nadelhalter	489	MURPHY Wundhaken	335
Micro-Vascular Nadelhalter PROMEDUR	491	MUSEUX Hakenzangen	281
Micro-Vascular Nadelhalter TITAN/DIAMANT	489	Muskelhaken	304,587
Micro-Vascular SELECT Nadelhalter	491	Muskelpinzetten	202,203
MIDDELDORF Wundhaken	342,343	Myrtenblattsonden	523
MIKRO anatomische Pinzetten	141		
Mikro-Arterienklemmen	221	N	
Mikro-Augenscheren	70	NABATOFF Krampfader-Besteck	543
Mikrochirurgie-Pinzetten	147,176-188	Nabelschnurscheren	116
Mikro-Clips	210	Nadeldosen	608,609
Mikro-Knupfpinzetten	176,180,182,183	Nadelhalter	469-505
Mikro-Nadelhalter	470,482,474-486	Nadelhalter fur Linkshander	488,489,490,497,498,505
Mikro-Nadelhalter mit Profilgriff	486,487	Nadelhalter, DIAMANT	482,483-485,486,487,488
Mikro-Nadelhalter PROMEDUR	479,480,482	Nadelhalter, Mikro-	470-486
Mikro-Nadelhalter TITAN	483-485	Nadelhalter, PROMEDUR	470,471,479,480-482,488-500
Mikro-Nadelhalter TITAN / DIAMANT	482,483-485	Nadelhalter, TITAN	483-485,489
Mikropinzetten atraumatisch	185	NAGEL Mikroscheren	87
Mikropinzetten atraumatisch TITAN	185	Nagelausreisszangen	33
Mikropinzetten mit Flachgriff	180	Nagelbohrer	33
Mikropinzetten mit Gegengewicht	180-181	Nagelfeilen	30
Mikropinzetten mit Gegengewicht DIAMANT	180-181	Nagelhautscheren	28,30
Mikropinzetten mit Gegengewicht TITAN	180-181	Nagelhautzangen	29
Mikropinzetten mit Gegengewicht TITAN-DIAMANT	180-181	Nagelscheren	28,30
Mikropinzetten mit Profilgriff	186-188	Nagelspaltscheren	33
Mikropinzetten mit Rundgriff	177,178-185	Nagelspaltzangen	28
Mikro-Ringpinzetten DIAMANT	184	Nagelzangen	28
Mikro-Ringpinzetten TITAN	184	Nahtpinzetten, Ophthalmologie	198-199
Mikro-Ringpinzetten TITAN-DIAMANT	184	Nasenflugelhakchen	308
Mikro-Scheren mit Bleistiftgriff	89	Nasenpinzetten	190
Mikroscheren mit Profilgriff	85-88	Nasensaugrohr	535
Mikroskopierpinzetten	161	Nasenscheren	119
MIKULICZ Peritoneumklemmen	270	NAUNTON-MORGAN Nadelhalter	495
MIKULICZ Wundhaken	348,349	NEGUS Tonsillenzangen	237
MIKULICZ-BABY Peritoneumklemme	270	NEIVERT Nadelhalter	502
MILLER Laryngoskope	39	NEIVERT Nasenfluegelretraktor	307
MILLER Rektumschere	112	NELATON Hohlsonde	523
MILLER Wundhaken	318	NELSON chirurgische Pinzetten	153
MILLER-BABY Laryngoskop	38,45	NELSON Trokare	541
MILLES I Mikroscheren	82,88	Nervhaken	309-314
MILLIGAN Wundspreizer	398	Nerv-Praparierschere	111
MILLIN Blasenhalsspreizer	464	Neurochirurgie-Pinzetten	175
MILLIN Blasenspreizer	464	NEW ORLEANS Nadelhalter	491
MILLS Gefascheren	110	NEWS Trachealhaken	322
Miniatur-Bulldog-Clips fur Arteria und Vena	216	Nierenfazangen	268
MINI-Bulldog Serrefine	211	Nierenschalen	610
MINIMUS Blutdruckmesser	9	Nierensteinzangen	267
MINI-Sterilisiercontainer	598	Nierenstielklemmen	266
Mischschalen	610	NISSEN Arterienklemmen	226
MISKIMON Wundspreizer	433	NORFOLK-NORWICH Wundspreizer	397
MIXTER Arterienklemmen	236	NOTO Uterus-Polypenzange	286
MIXTER Gallensteinsonde	527	NOVA-PRESAMETER Blutdruckmesser	8
MIXTER Gallensteinzangen	263,265	NOYES Irisscheren	70
MIXTER Praparierscheren	95	NUGENT Strabismuspinzetten	203
MIXTER-BABY Arterienklemmen	235	NUSSBAUM Darmklemmen	252
MIXTER-O'SHAUGHNESSY Arterienklemmen	233		
MOBERG Wundhaken	320	O	
MOCK Heparinnadel	547	O'BRIEN Fadenschere	117
MOD. WIEN Fadenfanger	517	OBWEGESER Kinnhalter	377
MODULAR (ahnlich Bookwalter) Retraktor System	439-441	OBWEGESER Progenie Rinnen	377
MOLLISON Wundspreizer	398	OBWEGESER Ramushaken	374,375
MOLTGEN Winkelmesser	22	OBWEGESER Spina nasalis-Haken	374
MOORFIELD Nahtpinzette	200	OBWEGESER Weichteilhaken	371,372
MORRIS Wundhaken	331,345	OCHSNER Fadenpinzette	507
MORRIS-MITRAL Gefaswundspreizer	409	OCHSNER Trokare	541
MOSQUITO Arterienklemmen	221	O'CONNOR Bindehautpinzette	193
MOSQUITO Arterienklemmen fur Linkshander	221	O'CONNOR Iriskakchen	302
MOSQUITO Arterienklemmen TITAN	221	OCULUS Lupenbrillen	19
MOYNIHAN Gallenkanalklemmen	262	OEHLER chirurgische Pinzetten PROMEDUR	166
MOYNIHAN Gallensteinsonde	527	Oersonden	522
MOYNIHAN Klemmzange	262	Ohrhakchen	305
MOYNIHAN Tuchklemmen	291		

	Seite		Seite
Ohrpinzetten	189	Pinzetten, Iris-, TITAN	140
Ohrspritzen	551	Pinzetten, Juwelier-	141
Ohrtrichterhalter	456	Pinzetten, Kapsel-	201
OLDBERG Wundhaken	314	Pinzetten, Knüpf-	160
OLIVECRONA Spateln, konkav und konvex	460	Pinzetten, Mikroskopie-	161
OLIVECRONA Trigeminiusschere	111	Pinzetten, Muskel-	202,203
OLLIER Wundhaken	336	Pinzetten, Nasen-	190
OLSEN-HEGAR Nadelhalter	498,505	Pinzetten, Ohr-	189
OLSEN-HEGAR Nadelhalter für Linkshänder	498,505	Pinzetten, Ophthalmologie-	191-207
OLVECRONA Arterienklemmen	229	Pinzetten, Splitter-	161
OMBREDANNE Darmfassklemme	245	Pinzetten, Strabismus-	202,203
ONG Iridektomiescheren	71	Pinzetten, Trachom-	204
Ophthalmologie, Pinzetten	191-207	Pinzetten, Uhrmacher-	141
Ophthalmologie, Nahtpinzetten	198-199	Pinzetten, Zahn-	173-174
Ophthalmoskope	13 - 17	Plazentar-, und Abortuszangen	287
Ortho-Wundspreizer	409	PLESTER Spülkanülen	534
OSCILLOW-E.P. Gipssägen elektrisch	558-560	PLESTER Wundspreizer	393
OSCILLOW-VAC Gipssäge mit Staubabsaugung	559	PLEY Sperrelevator	389
Osteotom für Autopsie	587	POCKET-ASSISTENT Taschenbesteck	511
O'SULLIVAN-O'CONNOR Bauchdeckenhalter	422,575	POCKET-MINI Nahtbesteck	509
Oto/Ophthalmoskop	13	POCKET-MULTI Nahtbesteck	510
Otoskope	13 - 15	POIRIER Arterienklemme	243
OVERHOLT-BABY Arterienklemmen	233	POLLOSON Lungenspateln	365
OVERHOLT-GEISSENDÖRFER Arterienklemmen	233	Polypezangen	295
OVERHOLT-MIXTER Arterienklemmen	233	POOLE Absaugrohre	538,578
		POOLE Absaugrohre für bariatrische Chirurgie	578
		POST-MORTEM-Klingen	50
P		POTTS Präparierschere	94
Parametriumscheren PROMEDUR	127	POTTS-DE-MARTEL Gefäßscheren	110
PARK Sperrelevator	389	POTTS-SMITH anatomische Pinzetten	145,146
PARKER Skalpelle	58	POTTS-SMITH anatomische Pinzetten TITAN	145
PARKER Wundhaken	328	POTTS-SMITH anatomische Pinzetten PROMEDUR	164
PARKER-LANGENBECK Wundhaken	329	POTTS-SMITH chirurgische Pinzetten	152
PARKER-MOTT Wundhaken	329	POTTS-SMITH Gefäßscheren	108,109
PARK-GUYTON Sperrelevator	389	POTTS-SMITH Gefäßscheren PROMEDUR	133
PARK-MAUMENEE Sperrelevator	389	POTTS-SMITH Gefäßscheren SUPERCUT	108,109
PAUFIQUE Fadenpinzette TITAN	198	POTTS-YASARGIL Mikroscheren mit Profilgriff	88
PAUFIQUE Fadenpinzetten	198	POZZI Hakenzange	277
PAYR Führungshohlsonden	516	Präparier- und Ligaturklemmen	225-236
PEAN Arterienklemmen	227	Präparierscheren	94,95-110
PEAN-FINO Arterienklemmen	228	Präparierscheren, fein	119,120,121
PECK-JOSEPH Präparierscheren	105	PRATT (Billroth) Hakenzange	280
PEERS Tuchklemmen	290	PRATT Cystikus-Haken	526
PEET Splitterzange	162	PRATT-"T"-Arterienklemme	248
PELKMANN Kornzangen	295	PRECISA Blutdruckmesser	8
Pelvishaken	360	PRESBYTERIAN Schlauchklemmen	292
PENNINGTON Arterienklemmen	243	PRICE-THOMAS Bronchusklemmen	240
Peritoneal-Pneu Kanüle	547	PRINCE Muskelpinzetten	205
Peritoneumklemmen	270-271	PRINCE Tonsillenschere	122
PERKINS Wundspreizer	399	Profilgriff-Mikronadelhalter	486-487
PERWITZSCHKY Speichelgangschere	123	Profilgriff-Mikropinzetten	186-188
Petrischale	609	Profilgriff-Mikroscheren	85-88
Phalangenmesser	59	Progenierinnen	377
PHANEUF Peritoneumklemmen	271	PRO-MED Laminektomie-Sperrer	442
PIERCE Oberkiefertrokare	542	PRO-MED Nadelhalter schedisches Modell	499
PIFFARD Hautkürette	32	PRO-MED-Select Fingerringssäge	34
PINARD Stethoskope	18	Prostata-Faßzange	269
Pinzette, Columnella-	190	PROVIDENCE-HOSPITAL Arterienklemmen	222
Pinzetten für Mikrochirurgie	176-188	Punktionskanülen	545
Pinzetten für Neurochirurgie	175		
Pinzetten, feine anatomische	140 - 143,0145-146	Q	
Pinzetten, anatomisch PROMEDUR	164-165	QUINBY Zahnfleischschere	121
Pinzetten, atraumatische TITAN	158-159	QUINCKE Lumbal-Punktionskanülen	545
Pinzetten, Bindehaut-	193		
Pinzetten, bipolar	167-171	R	
Pinzetten, Chalazions-	204-207	Rachiotom	587
Pinzetten, chirurgisch	148-155	RADOLF Nagelausreisszange	33
Pinzetten, chirurgisch PRUMEDUR	164-165	RAGNELL (Kilner) Präparierschere PROMEDUR	124
Pinzetten, chirurgische TITAN	148-149,151,153	RAGNELL-DAVIS Wundhaken,doppelendig	321
Pinzetten, Cilien-	163	RAMEL Brustfell-Biopsienadel	546
Pinzetten, Deckglas-	162	RAMPLEY Schwammzangen	294
Pinzetten, Faß-	156	RAMSEY anatomische Pinzetten	145
Pinzetten, feine chirurgische	140 - 143,0145-146	RAMSEY chirurgische Pinzetten	152
Pinzetten, Fremdkörper-	163	Ramushaken	374-376
Pinzetten, Iris-	140,191-193		

	Seite		Seite
RANDALL Nierensteinzangen	267	SATINSKY Gefäßschere	107
RANKIN-CRILE Arterienklemmen	224	Sattelhaken	324-326
RANKIN-KELLY Arterienklemmen	224	SAUER Sperrelevator	388
Rasieklingen brechbar	64	SAUERBRUCH Abfallzange	298
Rasiermesser	61	SAUERBRUCH Nadeldose	609
Raspatorien für bariatrische Chirurgie	579	SAUERBRUCH Wundhaken	349
REDON Führungsnadeln	540	Saugkanülen	530-536
Reflexhämmer	16	Saugkanülen für Ophthalmologie	535
REILL Mikro-Nadelhalter	474	Saugrohre	532,577,578
REINER Gipsmesser	556	Saugrohre für bariatrische Chirurgie	577,578
REKORD Spritzen	548	SAWTELL Tonsillenzangen	237
Rektumscheren	112,113	SCALP-CONTOUR Wundspreizer	393
RESANO atraumatische Darmklemme	258	Schädelspalter	587
RESANO Kapselschere	123	SCHAEDEL Tuchklemmen	290
Resektionsmesser	60	SCHAMBERG Komedonenquetscher	31
REVERDIN Ligaturnadeln	513	Scharfe Löffel für bariatrische Chirurgie	579
REVERDIN Spateln	355	Scheren für plastische Chirurgie	119, 122
REYNOLDS Präparierscheren	104	Scheren, Anatomie-	93
REYNOLDS Präparierscheren SUPERCUT	104	Scheren, Arteriötomie-	108
RHOTON Knüpppinzetten	182,183	Scheren, chirurgische	93,94,96,121
RHOTON Mikropinzetten	181-184	Scheren, chirurgische, fein	93-95
RHOTON Ringpinzetten	184	Scheren, Darm-	112
RHOTON-"BALANCE" Mikropinzetten	180,181,184	Scheren, Draht-	117,134
RIBBON Bauchspateln	355	Scheren, Draht- PROMEDUR	134
RIBBON Fadenschere	66	Scheren, Dura-	111
RIBBON Irisscheren	66	Scheren, Episiotomie-	115,116
RIBBON Strabismusschere	66	Scheren, Faden-	117
RIBBON-KAYE Lidplastikschere	66	Scheren, Fistel-	95
RIBBON-STEVENS Irisscheren	66	Scheren, für bariatrische Chirurgie PROMEDUR	565
RICARD Bauchdeckenhalter	413	Scheren, Gefäß-	107-110
RICHARDSON Wundhaken	343	Scheren, Gefäß- PROMEDUR	133,134
RICHARDSON-EASTMAN Wundhaken	343	Scheren, Gips-	137,139
RICHTER-HEATH Klammerzängchen	507	Scheren, gynäkologisch	114,115,126
RIGBY Wundspreizer	410	Scheren, gynäkologische- PROMEDUR	126
Ringstripper	543	Scheren, Hypophysektomie-	90
RITTER-HALLE Sonden	524	Scheren, Inzisions-	95
ROBERTS Arterienklemmen	228	Scheren, Iris-	65,124,134,137
ROBIN-MASSE Bauchdeckenhalter	414	Scheren, Kapsel-	123
ROCHARD Befestigungsgestelle	423	Scheren, Knorpel-	123
ROCHARD Fixiervorrichtung	423	Scheren, Kropf-	123
ROCHARD Haken	423	Scheren, Ligatur-	117,134
ROCHESTER-CARMALT Arterienklemmen	227	Scheren, Linkshänder-	91, 92
ROCHESTER-OCHSNER Arterienklemmen	232,570	Scheren, Lungen-	100,107,564
ROCHESTER-PEAN Arterienklemmen	228,568	Scheren, Nabelschnur-	116
ROEDER Tuchklemmen	291	Scheren, Nasen- SUPERCUT	118,119
ROGGE Sterilisierzangen	298	Scheren, neurochirurgisch	111
ROLLET Tränensackhäkchen	302	Scheren, Parametrium- PROMEDUR	127
ROSE Trachealhaken	322	Scheren, Präparier-	94,95-110,127
ROSEN Spülkanülen	534	Scheren, Präparier- fein	120,121
ROSS Aortahaken	384	Scheren, Präparier- PROMEDUR	128-132
ROUX Wundhaken	330	Scheren, Rektum-	112,113
ROUX-BABY Wundhaken	330	Scheren, Rektum- PROMEDUR	127
ROUX-MINI Wundhaken	330	Scheren, Sehnen-	93
RUMEL Arterienklemmen	234	Scheren, Speichelgang-	123
RUSSIAN chirurgische Pinzetten	154,566	Scheren, Strabismus-	66,67,92,124
RYDER Nadelhalter	499	Scheren, Tonsillen-	122
RYDER-MINI Nadelhalter	499	Scheren, Transplantations-	120
RYDER-MINI-SELECT Nadelhalter DIAMANT	500	Scheren, Trigemini-	111
		Scheren, Uterus-	115
		Scheren, Verband-	136,138
		Scheren, Zahnfleisch-	105,106,121
		Schieblehre für Neurochirurgie	186
		Schieblehren	24,186
		Schielhaken	304
		Schilddrüsenhaken	343
		SCHIMMELBUSCH Sterilisiertrommeln	607
		SCHINK Dermatome	62
		Schlauchklemmen	292
		Schlauchklemmen mit Schutzbügel	292
		Schlauchroller	292
		Schleimhauthäkchen	306,307
		SCHMID Gefäß-Spülkanülen	536
		SCHMIEDEN-TAYLOR Duraschere	111
		SCHNIDT Tonsillenzangen	237
		SCHOEMAKER Kropfschere	123
S			
SAALFELD Komedonenquetscher	31		
SACHS Durahäkchen	310		
SAENGER Abortuszangen	287		
Sägeblätter für Autopsiesägen	585,586		
Sägeblätter für Gipssägen	560		
Samenstrang-Fixierklemme	269		
Samenstranghaken	327		
SAMII-Ringpinzetten mit Profilgriff	187,188		
SANTULLI Bulldogklemme	214		
SANVENERO chirurgische Scheren	121		
SAROT Arterienklemmen	230,569		
SAROT Bronchusklemmen	239		
SAROT Nadelhalter	495,504		
SATINSKY Gefäßklemmen	242		

	Seite		Seite
SCHOEMAKER-LOTH Ligaturschere	117	Sortiermagazin für Kennzeichnungsschilder	602
Schraubenmessgeräte	24	Spannrahmen für Container	593,595,597,599,601
SCHROEDER Hakenzangen	277,279	Speichelngngschere	123
SCHUKNECHT Wundsperrer	399	SPENCER Fadenscheren	117
SCHUMACHER Nabelschnurschere	116	SPENCER-WELLS Arterienklemmen	227
Schwammzangen	293-294	Sperrelevatoren	388-391
SCHWARTZ Anlegezange	211	Splitterpinzetten	161
SCHWARTZ Bulldogclips	211	Splitterzangen	162
SCHWEIGGER Nahtpinzetten	200	Spritzen	548-552
Schwesterngarnitur	30	Spülkanülen	534-536
SCOVILLE Hemilaminektomie-Spreizer	436	Spülschalen	610
SCOVILLE Hirnspateln	459	St.MARKS Pelvishaken	360
SCOVILLE Hirnspatel-Pinzetten	175	St.MARKS Pelvishaken mit Kaltlichtaufsatz	360
SCOVILLE Nervwurzelhaken	312,313	ST.MARKS Perinealspreizer	463
SCOVILLE-HAVERFIELD Laminektomie-Spreizer	437	St.MARTIN Nahtpinzette	198
SCOVILLE-RICHTER Laminektomie Spreizer	435	STACKE Ohrsonde	524
SCUDDER Darmklemmen	251	STAUDE-MOORE Hakenzange	276
SCUDDER-DEBAKEY Darmklemmen	259	STEINHÄUSER Zygomawundhaken	373
SCULPO Brustretractoren	367	STELZNER Rektumschere	113
SEGOND Hysterektomieklemmen	272	Sterilisation	592-607
SEGOND-LANDAU Hysterektomieklemmen	272	Sterilisierbehälter (1/1)	596
Sehnenscheidenhaken	320	Sterilisierbehälter (1/2)	592
Sehnenschere	93	Sterilisierbehälter (3/4)	594
Sektionsnadeln	588	Sterilisiercontainer für Mikro-Instrumente	607
SEMB Bronchusklemmen	241	Sterilisierklammern	299
SEMKEN anatomische Pinzetten	143	Sterilisierrahmen für Mikro-Instrument	606
SEMKEN anatomische Pinzetten PROMEDUR	164	Sterilisiertrummeln	607
SEMKEN anatomische Pinzetten TITAN	143	Sterilisierzangen	298
SEMKEN chirurgische Pinzetten	149	Sternal-Punktionsnadel	545
SEMM Bauchdeckenhalter	421	Stethoskope	18
SENN-GREEN Wundhaken	323	STEVENS Irispinzetten	191
SENN-MILLER Wundhaken doppelendig	321	STEVENS Nadelhalter	472
SENN-MILLER-BABY Wundhaken	321	STEVENS Sehnenschere	93
Sensibilitätsinstrumente	17	STEVENS Tenotomiehäkchen	304
Septumkanülen	549	STEVENSON Sperrelevator	389
Serrefine, MINI-Bulldog	211	STIEGLITZ Splitterzangen	162
SEUTIN Gipsschere	138	STILLE anatomische Pinzetten	144
SEXTON Wundspreizer	401	STILLE Gipsscheren	137
SHAAF Fremdkörperpinzette	163	STILLE Nierenstielklemmen	266
SHEA Allzweckhaken mit Kaltlicht	381	STILLE-BARRAYA chirurgische Pinzetten	155
SHEA Transplantatationsscheren	120	STILLE-HAGLUND Gipsspreizer	557
Sicherungsplomben	602	Stirnspiegel	20
Siebeinlage für MINI-Container	599	STONE chirurgische Pinzetten	153
SIEBENMANN Kieferhöhlen-Spülkanülen	536	Strabismuspinzetten	202,203
Siebkörbe für (1/1) Sterilisierbehälter	597	Strabismusscheren	92,124
Siebkörbe für (1/2) Sterilisierbehälter	593	Strabismusscheren PROMEDUR	124
Siebkörbe für (3/4) Sterilisierbehälter	595	Strabismusscheren SUPERCUT	92
Siebkörbe für Endoskopie-Instrumente	600	STRANDELL-STILLE Wundhaken	320
Siebkörbe mit Deckel	599,601	STRATTE Nadelhalter	495,504
SIEBOLD Uterusschere	115	STRINGER Instrumentenbügel	299
SILIKON Fixierstreifen	605	STRULLY Neurochirurgische Schere	111
SILIKON Noppenmatten	604	SUPERCUT Scheren 91-93,95,97-105,106,107,114,116,118,120,121	33
SILVER Dermatome	63	SYSTRUNK Nagelspaltschere	33
SIMON Fistelhaken	327		
SIMON Skalpelle	58	T	
SIMS Gynäkologische Scheren	114	Taschen-Abszessmesser	61
SIMS Gynäkologische Scheren SUPERCUT	114	Taschenbestecke	508-511
SIMS gynäkologische Scheren PROMEDUR	126	TAYLOR anatomische Pinzetten	146
SIMS-MAIER Polypenzangen	295	TAYLOR anatomische Pinzetten TITAN	146
SINGLEY (TUTTLE) chirurgische Pinzetten	154,567	TAYLOR chirurgische Pinzetten	152
Skalpelle	57,58	TAYLOR Reflexhammer 19 cm	16
Skalpellgriffe	50-56	TAYLOR Spinalhaken	309,408
Skalpellgriffe m. doppelter Aufnahme	52	TAYLOR Valven	438
Skalpellklingen	48-50	TAYLOR-CUSHING anatomische Pinzetten	146
Skalpellmesser	57	TAYLOR-CUSHING chirurgische Pinzetten	152
SKENE Hakenzange	279	TEALE Hakenzangen	281
SMILLIE Kniegelenk-Wundhaken	370	Teiler für 1/1 Container	597
SMITH (US-ARMY) Verband- und Kleiderscheren	136	Teiler für 1/2 Container	593
SMITH Drahtschere PROMDUR	134	Teiler für 3/4 Container	595
SMITH Sperrelevator	388	TEMPLE-FAY Laminektomie-Spreizer	436
SMITH-BUIE Analspreizer	463	TERSON Kapselpinzette	201
SMITHWICK Nervhaken	310	THOMS-ALLIS Gewebefaßklemme	244
SNELLEN Entropiumpinzette	204	THOMSON-WALKER Blasenhalsspreizer	465
SOFIELD Wundhaken	330	THOREK (HALLE) Präparierscheren	100
SOMER Uterusfasszange	282		

	Seite		Seite
THOREK Lungenschere	100	VARADY Phlebodissektoren u. -extraktoren	544
THORPE (Marchac) Schiebellehre	24	Varizeninstrumente	543-544
Thyroid- und Vulvaspreizer	407-409	VAUGHAN Taschen-Abszessmesser	61
TIEMANN Kugelzange	279	Velcromanschetten für Blutdruckmesser	10
TOENNIS Arterienklemmen	231	VENAE-SECTIO-Taschenbesteck	512
TOENNIS Durahäkchen	311	VENEN-(Knopf) Kanülen	547
TOENNIS Nadelhalter	492	Venenhäkchen	315
TOENNIS Präparierscheren	104	Venenhaken	324,325
TOENNIS-ADSON Präparierscheren	104	Venenschere	83,88
TOENNIS-ADSON Präparierscheren SUPERCUT	104	Verband, Gips	556-560
TOENNIS-ADSON Schere PROMEDUR	128	Verbandscheren	135,136,138
TOHOKU Tuchklemmen	291	VERRES Peritoneal-Pneu Kanülen	547
Tonsillenfaßzangen	237-238	VIDAL Lupusschaber	31
Tonsillkanülen	549	VIRCHOW Hirnmesser	60
Tonsillenscheren	122	VIRCHOW Knorpelmesser Holzheft	60
Trabekularsonden	521	VIRTUS (RALK) Splitterzangen	162
Trachealhäkchen	318,319	WISE Mikro-Knüpfpinzetten	160
Trachompinzetten	204	VITREKTOMIE Scheren	75
Tränenkanaldilatadoren	521	VOLKMANN Knochenhaken	335
Tränenkanalsonden	520,521	VOLKMANN Wundhaken 2zg, scharf, 11,5 cm	332,333
Transformator für CLAR Stirnspiegel	20	VOLLMAR Ringstripper	543
Transplantationscheren	120		
TRAVERS Wundspreizer	397	W	
Trennbleche	606	WACHENFELDT Klammerpinzette	506
TREVES chirurgische Pinzetten	153	WACHENFELDT Wundrandfaßpinzette	506
Trigeminusschere	111	WAGENER Ohrhäkchen	305
TROELTSCH Nasenpinzetten	190	WAGNER chirurgische Scheren	105
TROELTSCH Ohrpinzetten	189	WAGNER chirurgische Scheren SUPERCUT	105
TROEMNER Reflexhammer 25 cm	16	WALDMANN Episiotomiescheren	116
Trokare	541-542	WALKER Irisschere	92
TROUTMAN Fixierpinzette	194	WALTON Fingerringsägen	34
TROUTMAN Hornhautscheren	73	WALTON Gipsschere	138
TROUTMAN Klingenbrecher	64	WALTON Gipsspreizer	557
TROUTMAN-RECTUS Muskelpinzette	202	WALTON Schwammzangen	295
TÜBINGEN Mikrohäkchen	303	WALTON Wundspreizer	398
Tuch- und Schlauchklemmen, Tupferzangen	289-297,573	WALTON-Select Fingerringsäge	34
TUEBINGEN Fadenpinzetten	198	Wangenhaken	373
TUEBINGEN Haken/Scheidenhalter	347	WANGENSTEEN chirurgische Pinzetten	154,164
TUEBINGEN Wundspreizer	410	WANGENSTEEN Nadelhalter	494,504
TUFFIER Arterienklemme	243	WARTENBERG Nervrädchen	17
TUFFIER Bauchspatel	355	Wasserspritzen selbstfüllend	551,552
Tumor- und Gewebefaßpinzetten	179	WASSMUND Wundhaken	336
Tupferzangen	293-297	WATSON Dermatome	63
TURNBULL Nagelzangen	28	Wattefallbehälter	608
TURNER-WARWICK Bauchdeckenhalter kompl.	426-428	Wattespender	608
		Watteträger	529
U		WAUGH anatomische Pinzetten	146
UCKERMANN Watteträger	529	WAUGH chirurgische Pinzetten	155
Uhrmacherpinzetten	141	WEBER Aesthesiometer	22
ULRICH Tupferzangen	296	WEBSTER Nadelhalter	588,501
UNIVERSAL Allzweckscheren	136	WEBSTER Nadelhalter	501
UNIVERSAL Drahtschere	117	WECKER Irisscheren	71
UNIVERSAL Drahtschere PROMEDUR	134	Weichteilhaken	371,372
UNIVERSAL Trokare	541	WEISS Sperrelevator	388
UNIVERSAL Trokare	541	WEITLANER Wundspreizer	393,394
UNNA Komedonenquetscher	31	WEITLANER-BABY Wundspreizer	393
UNNA-VIDAL (GREG) Komedonenquetscher	31	WERTHEIM Arterienklemmen	270
Unterbindungsnadeln	514-515	WERTHEIM Hysterektomieklappen	272,274
Ureterzangen	268,269	WERTHEIM Präparierscheren	100
Ureterzangen atraumatisch	268	WERTHEIM-ATRAUMA Hysterektomieklappen	273,275
USA-Model anatomische Pinzetten	144	WERTHEIM-CULLEN Hysterektomieklappen	273
USA-Model Schlauchklemmen	292	WESTCOTT Augenscheren	71
Uterus-Faßzangen	282,283	WHITE Tonsillenfasszangen	237
Uterus-Polypenzangen	285,286	WICKHAM Anlegezange	215
Uterusscheren	115	WICKHAM Bulldog Klemmen	215
		WIENER Irishäkchen	302
V		WIGMORE Gipssäge	556
Valven für CASPAR Sperrer	445,448	WIJNEN Absaugrohr	538,578
VAN ALEYA Kieferhöhlen-Spülkanüle	542	WIJNEN Absaugrohr für Bariatrische Chirurgie	578
VANNAS Hornhautscheren	74	WIKSTROEM Arterienklemmen	235
VANNAS Irisscheren	74	WILDE Ohrpinzette	189
VANNAS Mikroscheren mit Profilgriff	86,88	WILDER Tränenkanaldilatadoren	521
VANNAS-MIKRO Scheren	76,77	WILLET Kopfschwanzzange	284
VANNAS-TÜBINGEN Nachstarscheren	74	WILLIAMS Gewebefaßklemme	245

WILLIAMS Sperrelevatoren	389
WILMER Augenschere	68
Winkelbleche	606
Winkelmesser	22
WINTER Abortuszangen	287
Wirbelkörperspreizer	430-432
WISCONSIN-FOREGGER Laryngoskope	41
WOLFF Gipsabreisszangen	557
WOODSON Dura-Separator	149
WORST Trabekularsonden	521
WULLSTEIN Mikro-Absaugrohr	532
WULLSTEIN Spül- u. Saugkanülen	534
WULLSTEIN Wundspreizer	398
Wund- und Blasenspritzen	550
Wundhaken	332-354, 358-362
Wundhaken, doppelendig	328-331
Wundklammerinstrumente	506-507
Wundspreizer	391-410
Wundspreizer federnd	391
Wundspreizer, Laminektomie-	401-405,434-438

Y

YANKAUER Absaugrohre	537,577
YANKAUER Absaugrohre für bariatrische Chirurgie	537,577
YASARGIL Mikroscheren mit Profilgriff	88
YASARGIL Tumorpinzetten	179
YASARGIL-Ringpinzetten mit Profilgriff	187
YOUNG Prostataklemme	269
YOUNG Zungenzange	36

Z

Zahnfleischscheren	105,106,121
Zahnpinzetten	173-174
Zangenbehälter	611
Zehenspreizer	393
ZENKER Arterienklemmen	230
ZENKER Wundhaken	353
ZIEGLER Sperrelevator	389
ZIEGLER Stirnspiegel	20
ZOELLNER Mikrokanülen	534
ZOELLNER Saugkanülen	534
Zungenzangen	36
Zygoma-Haken	381
Zygoma-Wundhaken	373

Alphabetical Index**A**

Abdominal Spatulas	354-357
Abdominal Speculum	424
ABRAMS Pleural Biopsy Needle	546
ADAIR Tenaculum Forceps	277
ADAMS Scalpels	58
ADLERKREUTZ Tissue Forceps	153
ADSON Dressing Forceps TITANIUM	142
ADSON Hemostatic Forceps	225
ADSON Hypophysectomy Forceps	175
ADSON Needleholder	503
ADSON Nerve Hook	309
ADSON Neurosurgical Dressing Forceps	175
ADSON Self-Retaining Retractors	394,395
ADSON Self-Retaining Retractors	404
ADSON Suction Tubes	531
ADSON Tissue Forceps	148,464
ADSON Tissue Forceps TITANIUM	148
ADSON Tissue Forceps PROMEDUR	164
ADSON-BABY Hemostatic Forceps	225
ADSON-BABY Self-Retaining Retractors	400
ADSON-BROWN Tissue Forceps	153
ADSON-BROWN Tissue Forceps PROMEDUR	166
ADSON-BROWN Tissue Forceps TITANIUM	153
ADSON-DEBAKEY Tissue Forceps	142
ADSON-GRAEFE Tissue Forceps	149
ADSON-MICRO Dressing Forceps	142
ADSON-MICRO Tissue Forceps	148,149
ADSON-SELECT Dressing Forceps	142
ADSON-SELECT Tissue Forceps	148
AEBLI Corneal Scissors	67
AEBLI Keratomy Scissors	74
Aesthesiometer	22
AGRICOLA Lacrimal Sac Retractor	390
ALABAMA Strabismus Forceps	203
ALAN-PARKS Rectal Spreader	462
Alar Retractors	308
ALLEN-KOCHER Intestinal Forceps	243
ALLIS Atraumatic Tissue Forceps	244
ALLIS Tissue Forceps	243
ALLIS-ADAIR Tissue Forceps	244
ALLIS-BABY Tissue Forceps	243
ALLISON Lung Spatulas	363
ALLPORT Earhooklet	305
ALLPORT Self-Retaining Retractors	392
ALM Self Retaining Retractors	391,392
ALY Algesimeter	17
Amputating Knives	59-60
ANATOMY Scalpel Handles	50
Anatomy Scissors	93
ANDERSON-ADSON Self-Retaining Retractors	395
Angiotribes	261
Antrum Wash Canulas	535
ANVIL Nail Splitter	33
Aorta Retractors	384
Applicators, Cotton-	529
Applying and Removing Forceps	216
Applying Forceps for Micro-Clips	210
Applying Forceps, Bulldog-	210,211,215,216
ARKANSAS Shapening Stone	61
ARRUGA Capsular Forceps	201
ARRUGA Needleholders	471
ARRUGA Specula	388
Arteriotomy Scissors	79,80,81,87
ARTHUR Splinter Forceps	162
Aspirating Cannulas	530-539
Atrium Retractors	382
AUFRANC Cobra Bonelevers	369
AUFRICHT Hook for Posterior Nares	307
AUFRICHT Nasal Scissors	119
AUFRICHT Retractor	307
AUSTIN Suture Tying Forceps	160

AUTOFILL Irrigating Syringe	551
AUTOPSY Saws and Accessories	585,586
AXENFELD Skin Hooks	303
AYER Chalazion Forceps	206

B

BABCOCK Tissue Forceps	245,573
BABCOCK Tissue Forceps for Batriatic Surgery	573
BABCOCK Tissue Forceps PROMEDUR	246
BABCOCK-DEBAKEY Tissue Forceps	246
BABINSKY Percussion Hammer	16
BABY-KOCHER Intestinal Forceps	249
BACKHAUS Towel Forceps	290
BACKHAUS Towel Forceps with tubeholder	290
BADGLEY Laminectomy Retractor	434
BAINBRIDGE Hemostatic Forceps	227
BAKES Common Bile Duct Dilators	528
BALFOUR Abdominal Retractors	415-417
BALFOUR fourth Blade Attachments	417
BALFOUR-BABY Abdominal Retractor	415
BALL and SOCKET Towel Forceps for paper drapes	291
BALLENGER Sponge Forceps	293
BALLENGER Tonsil Seizing Forceps	238
Bandage Scissors	135,136
BANDIT-LEKSELL Rongeurs for BARIATRIC SURGERY	580
BARIATRIC SURGERY Instruments	563-580
BARON Suction Tubes	535
BARR Anal Retractor	463
BARRAQUER (Colibri) Eye Specula	388
BARRAQUER Anterior Chamber Forceps	202
BARRAQUER Bladholder/breaker	64
BARRAQUER Cilia Forceps	163
BARRAQUER Fixation Forceps	196
BARRAQUER Needleholders	472,473
BARRAQUER Scissors	71
BARRAQUER Suture Forceps	194,199
BARRAQUER-COLIBRI Fixation Forceps	194
BARRAQUER-KATZIN Iris Forceps	194
BARRET Tenaculum Forceps	276
BARRON Scalpel Handle	54
BARSKY Skinhook	307
BAUER Intra Oral Retractors	378
BAUMGARTNER Needleholders	488,501
BECKMAN Self-Retaining Retractors	403
BECKMAN-EATON Retractor	403
BECKMANN-ADSON Self-Retaining Retractors	404
BECKMANN-WEITLANER Retractors	402
BEEBEE Wire Cutting Scissors	117
BEER Cilia Forceps	163
BEESON Plaster Cast Spreader	557
BENGOLEA Hemostatic Forceps	226
BERENS Muscular Clamp	205
BERGH Cilia Forceps	163
BERGMANN Bandage Shears	136
BERGMANN Plaster Saw	556
BERGMANN Retractor	315
BERGMANN-FOERSTER Sponge Forceps	293
BERKE Muscular Forceps	205
BERLINER Percussion Hammers	16
BERNHARD Towel Forceps	291
BERRY STERNAL Needleholder	492
BERTILLON Cephalometer	23
BEST Intestinal Forceps	253
BIEMER Vein Scissors	83,88
Biopsy Cannulas	546
Biopsy Needles	545,546
Biopsy Needles, Liver	545
BIPOL-Cables for Bipolar Fprceps	172
BIRKETT Hemostatic Forceps	238
BISHOP-HARMAN Iris Forceps	192
Blade Remover	50
BLAKE Gall Stone Forceps	264
BLANK atraumatic Dressing Forceps	144
BLASCOVICS Muscular Forceps	205

	Page		Page
BLESSING Rectal Surgery Scissors	127	CALIPER for Neurosurgery	186
BLOHMKE Tonsil Seizing Forceps	238	Calipers	23,24
BLOUNT Knee Retractor	370	Cannulas, Antrum Wash-	536
BOETTCHER Tonsil Scissors	122	Cannulas, Aspirating-	530-539
BONACCOLTO Strabismus Forceps	203	Cannulas, Biopsy-	546
BONACCOLTO Suture Forceps	200	Cannulas, Insufflation-	547
Bone Curettes for BARIATRIC SURGERY	579	Cannulas, Irrigating-	534-536
Bone Measuring Caliper	23	Cannulas, Puncture-	545
Bone Rongeurs for BARIATRIC SURGERY	580	Cannulas, Venous-	547
Bonehooks	335,368-370	CANNY-RYALL Retractors	329
BONN Iris Forceps	193	CAPLAN Nasal Scissors	122
BONN Iris Scissors	67	CARMALT Splinter Forceps	161
BONN Iris Scissors SUPERCUT	67	CARREL Hemostatic Forceps	220
BONN Micro Hook	303	CARROL Finger-Goniometer	22
BONN Strabismus Scissors	67	Cartilage Knives	60
BONN Strabismus Scissors SUPERCUT	67	Cartilage Scissors	123
BONN Suture Forceps	198	Cases, Needle-	608,609
BONNEY Dressing Forceps	145,165	CASPAR Retractors	340
BONNEY Dressing Forceps PROMEDUR	165	CASPAR Retractors for Neurosurgery	445-453
BONNEY Tissue Forceps	153,166	CASTROVIEJO Anterior Synechia Scissors	72
BONNEY Tissue Forceps PROMEDUR	166	CASTROVIEJO Bladebreakers	64
BOROWSKI Atrium Retractors	382	CASTROVIEJO Calipers	23
BOSE Tracheal Dilator	391	CASTROVIEJO Capsular Forceps	201
Bowls, Kidney-	610	CASTROVIEJO Corneal Scissors	72
Bowls, round-	610	CASTROVIEJO Eye Specula	389
Bowls, solution-	610	CASTROVIEJO Fixation Forceps	197
BOWMAN Eye Specula	388	CASTROVIEJO Iridectomy Scissors	72,74
BOWMAN Lachrymal Probes	520	CASTROVIEJO Lacrymal Dilator	521
BOWMAN Scissors buttoned	107	CASTROVIEJO Needleholders	470
Boxes, Instrument-	612	CASTROVIEJO Suture Forceps	198
Boxes, Sterilizing- for Micro Instruments	607	CASTROVIEJO-MICRO Needleholders	473
BOYNTON Needleholder	470	CATLIN Amputating Knives	59
BOYS-ALLIS Tissue Forceps	244	Cephalometer	23
BOZEMANN Dressing Forceps	297	CHAPUT Intestinal Forceps	243
BOZEMANN Needleholder s	493,503	CHARNLEY Abdominal Retractor	429
BOZEMANN Uterine Scissors	115	CHARNLEY Horizontal Spreader	401
BOZEMANN-DOUGLAS Dressing Forceps	297	CHEATLE Sterilizing Forceps	298
Brain Knives	60	CHEEK Retractor	373
Brain Spatulas	459-460	CHERON Dressing Forceps	297
BRAUN Tenaculum Forceps	276	CHILDE Clip Forceps with magazine	506
BRAUN-STADLER Episiotomy Scissors	115	Cilia Forceps	163
Breast Retractors	367	Clamp, Spermatic Cord Fixation-	269
BRIDGE Hemostatic Forceps	227	Clamp, Urology	269
BROM Vein Hooks	315	Clamps, Bulldog-	212,213-215,217-219
BROMPTON Drainage Clamp	292	CLAR Headlights	20
Bronchus Clamps	240	CLARKE Eye Specula	388
Bronchus, Ligature, and Lung Grasping Forceps	239-242	Cleaning Stylet for FRAZIER/FERGUSON	533
BROPHY Dissecting Scissors	121	Cleaning Stylet for MAGILL Suction Tubes	536
BROPHY Dressing Forceps	144	Cloth Fastening Frames	593,595,597,599,601
BROPHY Tissue Forceps	151	CLOWARD Blade Retractors	309
BROWN Tissue Forceps	154	CLOWARD Dura Hook	311
BRUNETTI Chisels for opening Spinal Columns	587	CLOWARD Lamina Spreaders	443
BRUNNER Intestinal Forceps	253	CLOWARD Self-Retaining Retractors	430,431
BRUNNER Ligature Guides	517	CLOWARD-CONTOUR Retractors	400
BRUNNER Ligature Needles	515	CLOWARD-HOEN Spreader for Cervical Spine	432
BRUNNER Retractors	351,351	COAGULATING Forceps, bipolar-	167-171
BRUNS Plaster Shears	138,138	COAKLEY Antrum Trocar	542
Brush Dispensers	30	COBBETT Dermatome	63
Brushes, Nail-	30	COHAN Needleholders	472
BRYANT Dressing Forceps	295	COHAN-VANNAS Iridectomy Scissors	74
BÜCHS Cheek Retractor	375	COHEN Cuticle Nipper	29
BUCK Ligature Scissors	117	COLLIER Needleholder	501
BUCK Percussion Hammer	16	COLLIN Abdominal Retractors	411
BUIE Angiotribe	261	COLLIN Clip Removing Forceps	507
BUIE Fistula Probe	526	COLLIN Dynamometer	22
Bulldog Clamp Applying Forceps	210,211,215,216	COLLIN Intestinal Forceps	247
Bulldog Clamps	212,213-215,217-219	COLLIN Pelvimeter	25
Bulldog Clip for Arteria and Vena	216	COLLIN Polypus Forceps	297
BUMM Uterine Polypus and Ovum Forceps	286	COLLIN Retractors	329
BUNT Sterilizing Clip	299	COLLIN Tongue Holding Forceps	36
BUSCH Umbilical Scissors	116	COLLIN Uterine Elevating Forceps	283
		COLLIN-BABY Abdominal Retractor	411
		COLLIN-DUVAL Intestinal Forceps	156
		COLLIN-HARTMANN Retractor	330
		COLLIN-LOCKTITE Abdominal Retractor	412
C			
Cables for bipolar Coagulating Forceps	172		

	Page		Page
COLLYER Pelvimeter	25	DAVIS Sterilizing Forceps	298
COLVER Tonsil Seizing Forceps	238	DAY Ear Hooklets	305
Comedon Extractors	31	DEAN Tonsil Scissors	122,134
Common Bile Duct Dilators	528	DEAVER Retractor for BARIATRIC SURGERY	574
CONE Hemilaminectomy Retractors	397	DEAVER Retractors	357-359,574
Containers for Endoscopy Instruments	600	DEAVER Surgical Scissors	94
CONVERSE Alar Hooklet	308	DEBAKEY Bulldog Clamps	217,218
CONVERSE-ALAR Retractors	308	DEBAKEY Dissecting Scissors	104
COOK Eye Specula	390	DEBAKEY Femur-Retractors	407
COOLEY Atrium Retractors	383	DEBAKEY Heparin Cannulas	547
COOLEY Suction Tubes	539,578	DEBAKEY Needleholders	490,576
COOLEY Suction Tubes for Bariatric Surgery	578	DEBAKEY Needleholders for BARIATRIC SURGERY	576
COOLEY Vascular Tissue Forceps	158	DEBAKEY Suct.Tubes for BARIATRIC SURGERY	578
COOLEY Vascular Tissue Forceps TITANIUM	158	DEBAKEY SuctionTubes	539,578
COOPER Ligature Needle	515	DEBAKEY Tissue & Organ Grasping Forceps	248
COPE Retractor	322	DEBAKEY Tissue Forceps for Baratric Surgery	567
CORN Suture Forceps	507	DEBAKEY Vascular Dilators	525
Corneal Scissors	67,71,72,73	DEBAKEY Vascular Scissors	109,133
Coronary Scissors	79-81,87,88	DEBAKEY Vascular Tissue Forceps	157-158,165,567
COTTLE (Millard) Fingerring Retractor	308	DEBAKEY-GERALD Dressing Forceps	145
COTTLE Alar Hooklets	306	DEBAKEY-Micro Bulldog Clamps	217
COTTLE Columnella Forceps	190	DEBAKEY-Micro-Forceps	185
COTTLE Fixation Forceps	190	DEBAKEY-SATINSKY Bulldog Clamps	219
COTTLE Hooks for Posterior Nares	307	DEBAKEY-SELECT Needleholders	491
COTTLE-ALAR Retractor	308	Decompression Retractor	314
COTTLE-BULLDOG Nasal Scissors	118	DEJERINE Percussion Hammer	16
COTTLE-DORSAL Nasal Scissors	118	Delicate Dressing Forceps	141-147
COTTLE-MASING Nasal Scissors	119	DEMARTELL Vascular Scissors	110
COTTLE-NEIVERT Hook for Posterior Nares	307	DENIS- BROWNE Intestinal Forceps	156
Cotton Applicators	529	DENIS-BROWN Abdominal Retractors	418
Cotton Carriers for Rectoscopes	529	DENTAL Cartridge Syringes	552
COTTON Dispensers	608	DENTAL Sterilizing Containers	601
COTTON Waste Collectors	608	DENTAL Tweezers	173-174
COUPLAND Suction Tube	537	DERF Needleholder	488,501
Coverglass Forceps	162	Dermatology Instruments	31,32
COX Finger- and Toe Retractor	393	Dermatomes	63-63
CRAFOORD Hemostatic Forceps	229	DERMOT-PIERSE Fixation Forceps	195
CRAFOORD Thoracic Scissors	107	D'ERRICO Nerve Root Retractor	314
CRAFOORD-SELLORS Hemostatic Forceps	229	DESCHAMPS Ligature Needles	514
CRAWFORD Retractors	384	DESJARDINS Gall Duct Forceps	262
CRILE Hemostatic Forceps	222	DESJARDINS Gall Stone Forceps	264
CRILE Hemostatic Forceps TITANIUM	222	DESJARDINS Gall Stone Sounds	527
CRILE Needleholder	502	DESMARRES Chalazion Forceps	206
CRILE Nerve Hooklets	309	DESMARRES Lid Retractors	304
CRILE-BABY Hemostatic Forceps	222	Deviders for Containers	593,595,597
CRILE-MURRAY Needleholder	502	Diagnostics	8-20
CRILE-WOOD Needleholders	489,502	DICK Clamp-Forceps	271
CRITCHETT Eye Speculum	388	DIEFFENBACH Bulldog Clips	210
Cups, Medicine-	611	DIETHRICH Intracardiac Needleholders	500
Curettes, Bone- for BARIATRIC SURGERY	579	DIETRICH Bulldog Clamps	214
CUSHING Brain Spatulas	460	Dilators, Common Bile Duct-	528
CUSHING Decompression Retractor	314	Dilators, Frontal Sinus	524
CUSHING Dressing Forceps	145	Dilators, Lacrimal-	521
CUSHING Dressing Forceps PROMEDUR	164	DINGMAN Zygoma Hooks	381
CUSHING Dura Hook-Knife	311	Directors, grooved	523
CUSHING Dura Hooks	311	Dish, tablet-	611
CUSHING Nerve Hooklets	310,311	Dispenser for Identification Labels	602
CUSHING Nerve Hooks	326	Dispensers, Brush-	30
CUSHING Saddle Retractors	324	Dispensers, Cotton-	608
Cuticle Scissors	28	Dissecting- and Ligature Forceps	225-236
CZERNY Retractor	331	Dissecting Scissors	98-109,124-126,128-132
CZERNY Tumor Forceps	276	Dissector, Suction-	536
		Dissectors, Phlebo-	544
D		Dividers	606
DALE First Rib Rongeur for BARIATRIC SURGERY	580	DOCKHORN Cheek Retractors	373
DANDY Dura Scissors	111	Double Blade Handles	52
DANDY Nerve Hooks	310	DOUBLE PICKS	303
DANDY-MOSQUITO Hemostatic Forceps	223	DOUGLAS Antrum Trocar	542
DARLING Self-Retaining Retractors	407	DOUGLAS Cilia Forceps	163
DARTIGUES Kidney Elevating Forceps	268	DOYEN Abdominal Retractor Blades	424
DARTIGUES Uterine Elevating Forceps	283	DOYEN Director	523
DASTOOR Strabismus Forceps	203	DOYEN Gynecological Scissors	115
DAVIDSON Scapula Retractors	364	DOYEN Intestinal Forceps	249
DAVIS Brain Spatulas	459	DOYEN Needleholder	501
		DOYEN Polypus Forceps	265

	Page		Page
DOYEN Retractor	345	FERGUSON Gynecological Scissors	115
DOYEN Towel Forceps	290	FERGUSON Suction Tubes	533
DOYEN Uterine Polypus Forceps	285	FERGUSON Suction Tubes insulated	533
DOYEN-DEBAKEY Intestinal Clamps	255	FERGUSON Angiotribe	261
DOYEN-STILLE Retractors	345	FERRIS-SMITH Tissue Forceps	151
Drapes, Sterilizing-	604	FERROZELL Guiding Probes	517
Dressing- and Tissue Forceps	140-206	Filter Holder for Sterilizing Containers	603
Dressing- and Tissue Forceps PROMEDUR	164-166	Filters, paper Sterilizing Containers	603
Dressing Forceps	144,566	Filters, textile for Sterilizing Containers	604
Dressing Forceps FINO	144	Fine Surgical Scissors	91-95
Dressing Forceps for Bariatric Surgery	144,566	FINK Skin Hook	302
Dressing Forceps PROMEDUR	164	FINOCCHIETTO Bronchus Clamps	239
Dressing Forceps TITANIUM	144	FINOCCHIETTO Needleholders	493,503
Dressing Forceps USA-Model	144	FINSEN Self-Retaining Retractors	391
Dressing Forceps, non-traumatic	157-159	FISCH Suction Tips	531
Dressing Instruments	555-560	FISH Delicate Probes	524
Drums, Sterilizing-	607	FISHER-ARLT Iris Forceps	191
DUBOIS Kephaltomy Scissors	116	Fistula Hooks	327
DUEHRSEN Dressing Forceps	145	Fistula Scissors	95
DUEHRSEN Tissue Forceps	152	Fixation Clamps for Drapes	605
DUNHILL Hemostatic Forceps	222	Fixing bolt for Dividers	606
DUPLAY Polypus Forceps	296	Fixing bolt for instruments	606
DUPLAY Tenaculum Forceps	278	FLAGG Dental Tweezers	174
DUPLEX DE LUXE Stethoscope	18	FLAT Sterilizing Containers	598
DUPLEX Stethoscope	18	FLETCHER (Javerts) Sponge Forceps	294
DURANTE Tissue Forceps	155	FOERSTER Abdominal Retractor X-Ray	425
DUVAL Intestinal Forceps	156,247	FOERSTER Iris Forceps	192
DUVAL Intestinal Forceps Atraumatic	247	FOERSTER Sponge Forceps	293,573
Dynamometer	22	FOERSTER Sponge Forceps for BARIATRIC SURGERY	573
E			
Ear Dressing Forceps	189	FOMON Fine Hooklets	307
EICKEN-KILLIAN Antrum Wash Canulas	535	FOMON Nasal Scissors	118
EISELSBERG Ligature Scissors	117	FOMON-DORSAL Nasal Scissors	118
ELSCHNIG Capsular Forceps	201	Forceps, Cilia-	163
ELSCHNIG Fixation Forceps	196	Forceps, Coagulating bipolar-	167-171
EMMET Fistula Hooks	327	Forceps, Coverglass-	162
EMMET Sponge- and Dressing Forceps	296	Forceps, Dental-	173-174
Endoscopy Instrument Containers	600	Forceps, Dissecting-	225-236
ENGEL Plaster Saw	556	Forceps, Dressing and Tissue-	140-207
ENT Diagnostic Sets	11,12	Forceps, Dressing delicate-	141-147
Enterotomy Scissors	112-113	Forceps, Dressing non-traumatic-	157-159
Enucleation Scissors	69	Forceps, Ear Dressing-	189
Epicardial Spreaders, TITANIUM	392	Forceps, Foreign Body-	163
Episcleral Forceps	197	Forceps, Gall Duct-	262-263
Episiotomy Scissors	116	Forceps, Gall Stone-	264-265
ERHARDT Entropium Forceps	204	Forceps, Grasping-	156
ESMARCH Plaster Knife	556	Forceps, Hemostatic-	220-236
ESMARCH Plaster Shears	136	Forceps, Hemostatic, Placenta- and Ovum-	284-287
EWALD Dressing Forceps	142	Forceps, Hysterectomy-	272-275
EWALD Tissue Forceps	148	Forceps, Intestinal-	249-261
EXACTA Sphygmomanometer	9	Forceps, Jewellers-	141
EXTRA ORAL Sigmoid Notch Retractors	380	Forceps, Kidney-	266
Extractors, Phlebo-	544	Forceps, Kidney Stone-	267
Eye Forceps, Capsular-	200-201,204-205	Forceps, Kidney-Elevating-	268
Eye Forceps, Chalazion-	206,207	Forceps, Ligature-	225-236
Eye Forceps, Conjunctival-	193	Forceps, Micro-	176-188
Eye Forceps, Episcleral-	197	Forceps, Micro Dressing-	141
Eye Forceps, Fixation-	195,196,197	Forceps, Micro, counterbalanced-	180,181,184
Eye Forceps, Muscular-	204,205	Forceps, Micro-Tying-	178,180,182,183,184
Eye Forceps, Strabismus-	202,203	Forceps, Nasal Dressing-	190
Eye Forceps, Suture-	198-199	Forceps, Neurosurgical-	175,176
Eye Specula	388-390	Forceps, Ophthalmology-	140,191-207
F			
FAHLBUSCH Micro-Scissors	90	Forceps, Peritoneum-	270-271
FARABEUF Retractors	328	Forceps, PROMEDUR-	164-166
FARRELL Cotton Applicators	529	Forceps, Splinter-	161-162
FAURE Peritoneum Clamps	270	Forceps, Sterilizing-	298,299
FAVALORO Vascular Scissors	109	Forceps, Sterilizing- with jar	610
FEATHERLIGHT Bulldog Clamps	215	Forceps, Suture Tying-	160
FEHLAND-DEBAKEY Intestinal Clamp	257	Forceps, Tampon-	276-281
FEILCHENFELD Splinter Forceps	161	Forceps, Tenaculum-	148-155
FELDHEIM Tourniquet for Finger & Toes	32	Forceps, Tissue-	243-248
		Forceps, Tissue- and Organ Holding-	237,238
		Forceps, Tonsil-	176
		Forceps, Tumor-	179,184,187-188
		Forceps, Tumor- and Tissue Grasping-	268,269
		Forceps, Ureter-	

	Page		Page
Forceps, Uterine Elevating-	282-283	GREEN Strabismus Hook	304
Foreign Body Forceps	163	GREEN-ARMYTAGE Uterine Hemostat-Forceps	284
FOSTER-GILLIES Needleholders	497	GREGORY Bulldog Clamps	213
FOSTER-GILLIES Needleholders for left hand	497	GREGORY Micro- Needleholders	482
FOX Lupus Curettes	32	Grooved Directors	523
FRANKLIN-SILVERMAN Biopsyneedles	546	Grooved Directors with probe-end	523
FRAZIER Dura Hooks	311	GROSS Polypus Forceps	296
FRAZIER Suction Tubes insulated	533	GRUENWALD (Jansen) Tampon Forceps	190
FRAZIER Ventricular Canulas	531	Guide Needles	540
FREER Mucous Hook	306	Guiding Probes	516,517
FRITSCH Retractors	347	GUILEN Suction Raspatory	535
Frontal Sinus Dilators	524	GUILFORD Wire Cutting Scissors	117
FUCHS Capsular Forceps	201	GUNNAR-HEY Drainage Clamp	292
FUCHSIG Hemostatic Forceps	226	GUTHRIE Fixatation Hooks	302
FUKUSHIMA Suction Tubes	530	GUYON Kidney Pedicle Forceps	266,571
		GUYON Kidney Pedicle Forceps for BARIATRIC SURGERY	571
		Gynecological Scissors	114,126
G		H	
Gall Duct Forceps	262-263	HABERER Abdominal Spatulas	355
Gall Stone Forceps	264-265	HALSEY Needleholders	488,501
Gall Stone Sounds and -Probes	527	HALSEY-MICRO Needleholders	488
GARRETT Vascular Dilators	525	HALSTED Hemostatic Forceps	225
GAUSS Scalp Flap Forceps	284	HALSTED-MOSQUITO Forceps for LEFT HAND	221
Gauze Scissors	136	HARMS Trabecular Probes	521
GELPI Self-Retaining Retractors	408	HARRINGTON Bronchus Clamps	239
GELPI-BABY Self-Retaining Retractor	408	HARRINGTON Retractor / Lung Spatulas	361
GELPI-MINI Self-Retaining Retractor	408	HARRINGTON-PEMBERTON Retractor	361
GELPI-ORTHO Self-Retaining Retractor	409	HARRISON Sterilizing Forceps	298
GELPI-SELETZ Self-Retaining Retractor	409	HARTMANN Hemostatic Forceps	220
GEMINI Hemostatic Forceps	234,571	HARTMANN Suction Cannulas	535
GEMINI Hemostatic Forceps for BARIATRIC SURGERY	571	HARVEY Wire Cutting Scissors	117
GERALD Dressing Forceps	145	HARVEY-JACKSON Self-Retaining Retractor	405
GERALD Dressing Forceps TITANIUM	145	HAYES-DEBAKEY Intestinal Clamps	257
GERALD Dressing Forceps PROMEDUR	165	HEANEY (Hegar) Needleholder	494,504
GERALD Tissue Forceps	151	HEANEY Hysterectomy Forceps	272
GERALD Tissue Forceps TITANIUM	151	HEANEY Needleholders	494
GERALD Tissue Forceps PROMEDUR	165	HEANEY Retractors	362
GEUDEL-NEGUS Laryngoscopes	42	HEANEY-KANTER Hysterectomy Forceps	272
GILL Iris Forceps	193	HEANEY-REZAK Hysterectomy Forceps	272
GILL-HESS Iris Forceps	193	HEATH (Hunt) Chalazion Forceps	207
GILLIES Needleholders	498,505	HEGEMANN (Diethrich) Vascular Scissors	108
GILLIES Skin Hooks	31,315	HEGENBARTH Clip-Applying Forceps	506
GILLIES Tissue Forceps	149	HEIFETZ Brain Spatulas	456,459
GILLIES Tissue Forceps PROMEDUR	165	HEIFETZ Ring Tissue Forceps with profile-handle	187
GILLIES Tissue Forceps TITANIUM	149	HEIFETZ Tumor Forceps	179
GILLIES-MINI Needleholders	498,505	HEISS Hemostatic Forceps	226
GIL-VERNET Retractors	325	Hemilaminectomy Retractors	396
GLASSMANN atraumatic Forceps	159	Hemostatic Forceps	220-236
GLOVER Bulldog Clamps	212	Hemostats, Urology-	269
GOELET Retractor	331	HENLEY Self-Retaining Retractors	410
GOLDMAN-FOX Fine Dissecting Scissors	105,124	HENNING Plaster Cast Spreader	557
GOLDSTEIN Lacrimal Sac Rertractors	390	HENROTIN Vulsellum Forceps	280
Goniometers	22	HENRY Cilia Forceps	163
GOOD Tonsil Scissors	122	Heparin Flushing Needles	547
GORNEY (Killian) Nasal Scissors	122	HERMANN Plaster Cast Spreader	557
GORNEY Dissecting Scissors	106	HERRICK Kidney Pedicle Forceps	266
GORNEY Suction Dissector	536	HERTZLER Abdominal Retractor	415
GOSSET Abdominal Retractors	414	HESS Capsular Forceps	201
GRADLE Suture Scissors	117	HEYMANN Nasal Scissors	118
GRAEFE Eye Scissors	68	HEYWOOD-SMITH Uterine Polypus Forceps	285
GRAEFE Eys Specula	388	HIBBS Retractors	362
GRAEFE Fixation Forceps	196	HIBBS Spinal Blades	438
GRAEFE Iris Forceps	140,147,191	HOEN Nerve Hooklet	309
GRAEFE Iris Forceps TITANIUM	140,147,191	HOEN Neurosurgical Dressing Forceps	175
GRAEFE Iris Hooks	302	HOEN Spreader for Cervical Spine	432
GRAEFE Microhooks	303	HOESEL Needleholders	497
GRAEFE Strabismus Hooks	304	HOESEL Retractors	346
GRAEFE Tissue Forceps	147	HOLSCHER Nerve Hook	313
GRAEFE-SELECT Iris Forceps	140,147,191	HOLTZHEIMER Self-Retaining Retractors	392
GRAHAM Nerve Hooklet	309	HOLZBACH Abdominal Retractor	413
Grasping Forceps	156	Hooks for Posterior Nares	307,308
GRAY Gall Duct Forceps	263	Hooks, Bone-	368-370
GRAZIL Surgical Scissors	96	HOPKINS Plaster Knife	556
GREEN (Thyroid) Retractor	343		
GREEN Fixation Forceps	196		

	Page		Page
HORGAN Center Valves	417	JULIAN Needleholders	491
HOUSE Suction Tips	531		
HRYNTSCHAK Bladder Retractor	465	K	
HULKA Tenaculum Forceps	278	KADER Abdominal Spatulas	354
HULKA-KENWICK Tenaculum Forceps	278	KALT Capsular Forceps	201
HUMBY Dermatome	63	KALT Needleholders	471
HUNT Tumor Forceps	179	KALT-ARRUGA Needleholders	471
HUNTER Splinter Forceps	161	KANTROWITZ Hemostatic Forceps	234
Hysterectomy Forceps	272-275	KATSCH Comedon Extractor	31
		KATZIN Keroplastic Scissors	73
I		KATZIN-BARRAQUER Keroplastic Scissors	73
I.M.A Mammaria Spreader	461	KAYE Needleholders for Plastic Surgery	498
Identification Labels	602	KAYE Transplant Scissors	120
Instrument Boxes	612	KELLY Fistula Scissors	95,134
ILIC Cuticle Nipper	29	KELLY Hemostatic Forceps	222,230
Incision Scissors	95	KELLY Hemostatic Forceps TITANIUM	222
Indicating Labels	602	KELLY Ovum Forceps	287
INFANT Lacrymal Dilator	521	KELLY Retractors	344
Infusion-Bottle Opening Forceps	299	KELMAN-McPHERSON Suture Forceps	199
INGE Lamina Spreaders	444	Keratoplastic Scissors	73
INGE-BABY Lamina Spreaders	443	KERSTING Intestinal Clamp	258
Instrument Lubricant	608	KEYES Cutaneous Punches	32
Instrument lubricating oil	608	Kidney Clamps	266
Instrument Trays	612	Kidney Stone Forceps	267
Instruments for BARIATRIC SURGERY	563-580	Kidney-Bowls	610
Instruments, Post-Mortem-	584-588	Kidney-Elevating Forceps	268
Insufflation Cannulas	547	KILLIAN Wash Cannula	535
Intestinal Clamp Forceps	249-261	KILNER (Ragnell) Scissors	120,124
INTRA ORAL Retractors	378,379	KILNER Double Hook for Posterior Nares	308
INTRACARDIAC Needleholders	492	KILNER Needleholders	488,501
IOWA Mambrane Puncture Forceps	285	KILNER Plastic Surgery Scissors	119
IOWA Pudendus Anaesthesia Needle	547	KILNER Skin Hooks	31,315
Iridectomy Scissors	71,72,74	KIRKLIN Retractors malleable	324
Iris Forceps	140,191-194,	KIRSCH Cheek Retractors	373
Iris Scissors	66-68,70-72,74,91-92,124	KIRSCHNER Abdominal Retractors	419,420
Irrigating Cannulas	534-536	KIRSTEIN (Heymann) Nasal Scissors	118
Irrigating Syringe self-filling	552	KLAPP Tendon Hooks	320
ISRAEL Retractors	337	KLEINERT-KUTZ Retractors	31,315
		KLIMA-ROSEGGER Sternal Puncture Needle	545
J		KLINGENBERG-LOTH Dissecting Scissors	107
JACKSON Tracheal Retractors	322	KLING-EX Blade Remover	50
JACKSON-BURROWS Self-Retaining Retractor	409	KLINIKUM BERLIN Tubing Clamp	292
JACOBS Vulsellum Forceps	280	KNAPP (BLAIR) Skin Hook	302
JACOBSON Micro Scissors	82	KNAPP Iris Scissors	67
JACOBSON Needleholders	481	KNAPP Trachoma Forceps	204
JACOBSON-ADSON Forceps	176	Knee Retractors	370
JACOBSON-MICRO Forceps	176	Knives, Plaster-	556
JACOBSON-MICRO Hemostatic Forceps	221	KNOWLES Bandage Scissors	135
JAEGER Strabismus Hooks	304	KOCHER Hemostatic Forceps	231
JAMESON Caliper	24	KOCHER Intestinal Forceps	250
JAMESON Fine Dissecting Scissors	104	KOCHER Retractors	334,338,341,342
JAMESON Muscular Forceps	204	KOCHER-BABY Intestinal Forceps	249
JAMESON Strabismus Hook	304	KOCHER-DEBAKEY Intestinal Clamps	256
JAMESON-WERBER Fine Dissecting Scissors	104	KOCHER-FINO Hemostatic Forceps	231
JANET Syringes	550	KOCHER-WAGNER Retractors	347
JANSEN Self-Retaining Retractors	392	KOENIG Guiding Probes	516
Jars	611	KOENIG Nail Splitting	33
Jars, graduated	609	KOERTE Abdominal Spatula	356
JEFFERSON Dressing Forceps	143	KOERTE Retractors	336
JEFFERSON Tissue Forceps	149	KOGAN Endospecula	466
Jewellers Forceps	141	KÖNIG Retractors	320
JEWELLERS Forceps	141	KONRICH Sterilizing Drums	607
JOBSON-HORNE Cotton-Applicators	529	KRAUSE Antrum Trocar	542
JOERGENSON Dissecting	99	KRONECKER Ligature Needles	515
JOHN-HOPKINS Applying Forceps	210	KUEHNE Coverglass Forceps	162
JOHN-HOPKINS Bulldog Clips	210	KUEMMEL Abdominal Spatula	356
JOHN-HOPKINS Gall Duct Forceps	263	KÜSTNER Vulsellum Forceps	281
JOHNSON Needleholder	503		
JOLL (Friedmann) Self-Retaining Retractor	407	L	
JONES Towel Clips	290	LA GRANGE Sclerectomy Scissors	69
JOSEPH Mucosa Hooklets	306	Labels, Identifying-	602
JOSEPH Plastic Surgery Scissors	121	Lacrimal Probes	520,521
JUDD-ALLIS Tissue Forceps	244	Lacrymal Dilators	521
JUDD-MASON Bladder Retractors	464,465	LAHEY Dura-Hook	311

	Page		Page
LAHEY Gall Duct Forceps	262	MAGILL Suction Cannulas	536
LAHEY Thyroid Retractor	337	MAIER Polypus Forceps	296
LAHEY-METZENBAUM Dissecting Scissors	101	MALTZ Retractor	307
LAMBERT Chalazion Forceps	206	MANNERFELT Retractors	316,317
LAMBOTTE Bonehook	368	MARBERGER Saddle Retractors	325
Lamina Spreaders	443-445	MARINUS Intestinal Clamps	260
LANCASTER Eye Specula	389	MARKHAM-MEYERDING Self-Retaining Retractors	406
LANDAU Trocar	542	MARSCHIK Tonsil Seizing Forceps	238
LANDOLD Blade Handles	51	MARTEL Scalp Flap Forceps	284
LANE Bone Lever	368	MARTIN Cartilage Scissors	123
LANE Stomach Clamps	254	MARTIN Pelvimeter	25
LANE Tissue Forceps	154	MARTIN Retractor	348
LANE Towel Forceps for paper drapes	291	MARTIN Waste Forceps	298
LANE-TRETHOWAN Bone Lever	368	MASSON Needleholder	494,504,505
LANGE Choana Hook	307	MATHIEU Rectal Speculum	462
LANGENBECK Amputating Knife	59	MATHIEU Retractors	321,330
LANGENBECK Needleholders	493	MATHIEU-KOCHER Needleholders	496
LANGENBECK Resection Knives	60	MATHIEU-SLIM Needleholder	505
LANGENBECK Retractors	338,339,340	Maxillo-Facial Retractors	371-381
LANGENBECK-MINI Retractors	323	MAYO Dissecting Scissors	98,125
Laryngeal Cannula with LL-connection	549	MAYO Sterilizing Clips	299
LATERAL Vaginal Retractor	466	MAYO-ADAMS Abdominal Retractor	412
LAZAR Micro Tying Forceps	160	MAYO-BLAKE Gall Stone Forceps	265
LEGUEU Bladder Retractor	412	MAYO-GUYON Kidney Forceps	266
LEMPERT Cuticle Nipper	29	MAYO-HARRINGTON Dissecting Scissors	99,126
LERCHE Tissue Forceps	153	MAYO-HEGAR Needleholder	490,502,576,577
LERICHE Abdominal Spatulas	356	MAYO-HEGAR Needleholders for BARIATRIC SURGERY	576,576
LERICHE Hemostatic Forceps	223	MAYO-LEXER Dissecting Scissors	99,126
LERMOYEZ Sinus Trocars	542	MAYO-ROBSON Intestinal Forceps	251
LESTER Fixation Forceps	196	MAYO-RUSSIAN Tissue Forceps	154
LeVASSEUR-MERRILL Retractors	381	MAYO-STILLE Dissecting Scissors	98,125
LEXER-BABY Dissecting Scissors	100,124	McCOLLOUGH Strabismus Forceps	202
LEYLA Ear Specula Holder	456	McGUIRE Corneal Scissors	67
LEYLA Retractor System	455-458	McINDOE Dressing Forceps	143
LICHTENBERG Needleholder	496	McINDOE Dressing Forceps PROMEDUR	165
LICHTWITZ Antrum Trocar	541	McINDOE Dressing Forceps TITANIUM	143
LIEBERMANN Eye Specula	390	McINDOE Plastic Surgery Scissors	122
Ligature Conductors	516,517	McINTOSH Laryngoscopes	37-38,43-44
Ligature Fork	517	McPHERSON Suture Forceps	199
Ligature Needles	513-515	Measuring Instruments	22-25
Ligature Scissors	117,134	Measuring Jugs, graduated	609
LISTER Bandage Scissors	135	Medicine Cups	611
LISTER-BURCH Eye Specula	389	Medicine Spoon	611
LISTER-EXCENTRIC Bandage Scissors	135	MEEKER Hemostatic Forceps	235
LISTER-SINUS Dressing Forceps	295	MELLINGER Eye Specula	389
LISTON Amputating Knives	59	MEMORY Brain Spatulas	460
LITTAUER Cilia Forceps	163	MENGHINI Biopsy Needles	545
LITTAUER Nail Splitting Forceps	28	MENGHINI Liver Biopsy Needles	545
LITTAUER Stitch Scissors	117	MERIAM Dental Tweezers	174
LITTLE Retractor	337	METZENBAUM Dissecting Scissors	101-103,130-132,564
LITTLEWOOD Tissue Forceps	244	METZENBAUM Dissecting Scissors, bariatric	564
Liver Biopsy Needles	545	METZENBAUM Needleholder	503
LLOYD-DAVIS Rectal Scissors	113	METZENBAUM-BABY Dissecting Scissors	100
LLOYD-DAVIS Sigmoid Anastomosis Clamp	261	METZENBAUM-FINO Dissecting Scissors	103,130-132
LOCKHART-MUMMERY Sounds	523	MEYERDING Retractors	319
LOCKLIN Gum Scissors	106,134	MEYERDING Self-Retaining Retractors	406
LOCKWOOD Tissue Forceps	245	MEYERDING Spinal Blades	438
LONDON-COLLEGE Dental Tweezers	173	MEYER-SCHWICKERATH Locator	302
LORDAN Chalazion Forceps	207	MICHEL Clip Applying & Removing Forceps	506
LORENZ Bandage Scissors	135	MICHEL Clips	507
LORNA (Edna) Towel Forceps for paper drapes	291	MICHEL Suture Clip Set	508
LOVE Nerve Hooks	312	Micro Dissecting Scissors with profile handle	85-88
LOVELACE Hemostatic Forceps	223	Micro Dressing Forceps	141
LOVELACE Lunggrasping Forceps	241	Micro Forceps	176-188
LOWER Gall Duct Forceps	263	Micro Forceps with profile-handle	186-188
Lubricating Oil	608	Micro Forceps, counterbalanced	180,181,184
LUCAE Ear Dressing Forceps	189	Micro Scissors	70,78,82-89
LUCAE Ear Hooklets	305	Micro Tissue Forceps	147
LUKENS Thymus Retractor	322	Micro Tying Forceps	178,180,182,183,184
Lung Spatulas	361,363,365-366	Micro-Clips	210
LURZ Ureter Clamps	269	Micro-Mosquito Hemostatic Forceps	221
		Micro-Needleholders	470-487
		Microscopic Forceps	161
		Micro-Vascular Needleholders	489,491
		MIDDELDORF Retractors	342,343
M			
MAGILL Catheter Introducing Forceps	36		

	Page		Page
MIKULICZ Peritoneum Clamps	270	NEWS Tracheal Hook	322
MIKULICZ-BABY Peritoneum Clamp	270	NICOLA Micro-Scissors	90
MILLER Delicate Retractors	318	NISSEN Hemostatic Forceps	226
MILLER Laryngoscopes	45-46	NORFOLK-NORWICH Self-Retaining Retractors	397
MILLER Rectal Scissors	112	NOTO Uterine Polypus Forceps	286
MILLER-BABY Laryngoscope	38-40,45	NOVA-PRESAMETER Manometer	8
MILLES Micro Scissors	82	NOYES Iris Scissors	70
MILLES Micro Scissors with profile handle	88	NUGENT Strabismus Forceps	203
MILLIGAN Self-Retaining Retractors	398	NUSSBAUM Intestinal Forceps	252
MILLIN Bladder Neck Spreader	464		
MILLIN Bladder Retractor	464	O	
MILLS Vascular Scissors	110	O'BRIEN Stitch Scissors	117
MINI Sterilizing Containers	598	OBWEGESER Chin Retractor	377
MINI-Bulldog Clips	211	OBWEGESER Maxillo-Facial Retractors	371,372,374,375,377
MINIMUS II Sphygmomanometer	9	OCHSNER Suture Forceps	507
MISKIMON Cerebral Spreader	433	OCHSNER Trocars	541
MIXTER Dissecting Scissors	95	O'CONNOR Conjunctiva Forceps	193
MIXTER Gall Stone Forceps	263,265	O'CONNOR Iris Hook	302
MIXTER Gall Stone Probe	527	OCULUS Operating Loupes	19
MIXTER-BABY Hemostatic Forceps	235,236	OEHLER Tissue Forceps PROMEDUR	166
MIXTER-O'SHAUGHNESSY Hemostatic Forceps	233	Oil, lubricating-	608
MOBERG Retractors	320	OLDBERG Retractors	314
MOCK Heparin Flushing Needle	547	OLIVECRONA Brain Spatulas	460
MODULAR (sim. Bookwalter) Retractor Sets	439-441	OLIVECRONA Trigeminal Scissors	111
MOELTGEN Goniometer	22	OLLIER Retractors	336
MOLLISON Self-Retaining Retractors	398	OLSEN-HEGAR Needleholder for left hand	498,505
MOORFIELD Suture Forceps	200	OLSEN-HEGAR Needleholders	498,505
MORRIS Retractors	331,345	OLVECRONA Hemostatic Forceps	229
MORRIS-MITRAL Vascular Retractor	409	OMBREDANNE Tissue Forceps	245
MOSQUITO Hemostatic Forceps	221	ONG Iridectomy Scissors	71
MOSQUITO Hemostatic Forceps TITANIUM	221	Operating Loupes	19
MOYNIHAN Gall Duct Forceps	262	Operating Scissors	98-97,125
MOYNIHAN Gall Stone Probe	527	Ophthalmoscopes	11-14
MOYNIHAN Towel Forceps	291	OSCILLOW Plaster Cast Cutters, electric	558
Mucosa Hooklets	306	O'SULLIVAN-O'CONNOR Abdominal Retractor	422,575
MUELLER Eye Specula	389	Oto-Ophthalmoscopes	13-15
MULDOON Lacrymal Dilator	521	Otoscopes	11-15
MURDOCK Eye Specula	388	OVERHOLT-BABY Hemostatic Forceps	233
MURPHY Retractors	335	OVERHOLT-GEISSENDOERFER Hemostatic Forceps	233
Muscle hook	587	OVERHOLT-MIXTER Hemostatic Forceps	233
MUSEUX Vulsellum Forceps	281		
MYRTLE LEAF Probes	523	P	
		Pads, Silicone-	604
N		PARAMETRIUM Scissors	127
NABATOFF Varicose Strippers	543	PARK Eye Specula	389
NAGEL Micro-Scissors	87	PARKER Retractors	328
Nail Drill Set	33	PARKER Scalpels	58
Nail Files	30	PARKER-LANGENBECK Retractors	329
Nail Nippers	28	PARKER-MOTT Retractor	329
Nail Scissors	28,33	PARK-GUYTON Eye Specula	389
Nail Scissors & Nail File with chain	30	PARK-MAUMENEE Eye Specula	389
Nail Splitting Forceps	28	PAUFIQUE Suture Forceps	198
Nailbrush autoclavable	30	PAYR Guiding Probes	516
Nasal Dressing Forceps	190	PEAN Hemostatic Forceps	227
Nasal Scissors	118,-120,134	PEAN-FINO Hemostatic Forceps	228
Nasal Suction Tip	535	PECK-JOSEPH Fine Dissecting Scissors	105
NAUNTON-MORGAN Needleholder	495	PEERS Towel Forceps for paper drapes	290
Needle Cases	608,609	PEET Splinter Forceps	162
Needleholders	470-504	PELKMANN Dressing Forceps	295
Needles, Heparin-	547	Pelvimeters	25
Needles, Pudendus Anaesthesia-	547	Pelvis Retractors	360
NEGUS Tonsil Forceps	237	PENNINGTON Hemostic Forceps	243
NEIVERT Hook for Posterior Nares	307	Periosteum Knife	60
NEIVERT Needleholders	489,502	Peritoneum Forceps	270-271
NELATON Director	523	PERKINS Self-Retaining Retractors	399
NELSON Tissue Forceps	153	PERWITZSCHKY Salivary Gland Scissors	123
NELSON Trocars	541	PETRI Dish	609
Nerv Dissecting Scissors	111	Phalangeal Knife	59
Nerve Hooks	326	PHANEUF Peritoneum Clamps	271
Nerve Root Retractors	314	Phlebotomizers and Extractors	544
Neurosurgical Dressing Forceps	175,176	PIERCE Antrum Trocars	542
Neurosurgical Forceps	175	PIFFARD Lupus Curettes	32
Neurosurgical Scissors	111	PINARD Stethoscopes	18
NEW ORLEANS Needleholder	491	Pituitary Scissors	90

	Page		Page
Placenta- and Ovum Forceps	284-287	RANKIN-KELLY Hemostatic Forceps	224
Plaster Cast Breakers	557	Raspatories for BARIATRIC SURGERY	579
Plaster Cast Spreaders	557	Raspatory, Suction-	535
Plaster Instruments	555-560	Razor 61	
Plaster Knives	556	Razor-Blades breakable	64
Plaster Saws	556,	RECORD Syringes, Luer	548
Plaster Saws, electric	558-560	RECORD Syringes, Luer-Lock	548
Plaster Shears	137	Rectal Scissors	113
Plastic Surgery Scissors	119,120-122,124	Rectal Specula	462,463
PLESTER Self-Retaining Retractors	393	REDON Guide Needles	540
PLESTER Suction Tubes	534	REILL Micro-Needleholders	474
Pleural Biopsy Needles	546	REINER Plaster Knife	556
PLEY Eye Speculum	389	REINER-ALEXANDER Ear Syringes	551
Pneumoperitoneal Biopsy Needles	547	RESANO Cartilage Scissors	123
POCKET Suture Sets	509-511	RESANO Intestinal Clamp	258
POCKET Venae-Sectio Set	512	Retractor, Decompression-	314
POIRIER Intestinal Forceps	243	Retractor, Thyroid-	337,343
POLLOSON Retractors	365,366	Retractors, delicate-	318,319
POOLE Suction Tubes	538,578	Retractors, Knee-	370
POOLE Suction Tubes for BARIATRIC SURGERY	578	Retractors, Nerve Hook-	326
Post-Mortem Chisels	587	Retractors, Nerve Root-	314
Post-Mortem Hammer	587	Retractors, Scapula-	364
Post-Mortem Instrument Set	584	Retractors, Sculpo-	367
Post-Mortem Instruments	584-588	Retractors, Self-Retaining-	399-466
Post-Mortem Needles	588	Retractors, Thymus-	322
Post-Mortem Scalpelblades	50	Retractors, Trachea-	318
POTTS Dissecting Scissors	94	Retractors, Tracheal-	322
POTTS-DE-MARTEL Vascular Scissors	110	Retractors, Pelvis-	360
POTTS-SMITH Dressing Forceps	145,146,164	REVERDIN Abdominal Spatula	355
POTTS-SMITH Dressing Forceps PROMEDUR	164	REVERDIN Ligature Needles	513
POTTS-SMITH Dressing Forceps TITANIUM	145	REYNOLDS Dissecting Scissors	104
POTTS-SMITH Tissue Forceps	152	RHOTON Micro-Forceps	181-184
POTTS-SMITH Vascular Scissors	108,133	RHOTON Micro-Forceps TITANIUM	181-184
POTTS-YASARGIL Scissors with profile handle	88	RHOTON Micro-Forceps TITANIUM DIAMOND	181-184
POZZI Tenaculum Forceps	277	RIBBON Abdominal Spatulas	355
PRATT (Billroth) Tumor Forceps	280	RIBBON Iris Scissors	66
PRATT Crypt Hooks	526	RIBBON Stitch- and Suture Scissors	66
PRATT-"T" Hemostatic Forceps	248	RIBBON-KAYE Blepharoplasty Scissors	66
PRECISA Sphygmanometer	8	RIBBON-STEVENS Scissors	66
PRESBYTERIAN Tubing Clamps	292	RIBBON-Strabismus Scissors	66
PRICE-THOMAS Bronchus Clamps	240	RICARD Abdominal Retractors	413
PRINCE Muscular Forceps	205	RICHARDSON Retractors	343
PRINCE Tonsil Scissors	122	RICHARDSON-EASTMAN Retractors	343
Probes 522-527		RICHTER-HEATH Clip Removing Forceps	507
Probes for BARIATRIC SURGERY	577	RIGBY Self-Retaining Retractors	410
Probes with eye	522	Ring Tissue Forceps with profile-handle	187
Probes, Ear-	524	RITTER-HALLE Frontal Sinus Dilators	524
Probes, Fistula-	523,526	ROBERTS Hemostatic Forceps	228
Probes, Gall Duct-	527	ROBIN-MASSE Abdominal Retractor	414
Probes, Gall Stone-	527	ROCHARD Fixation Device	423
Probes, Lacrimal-	520,521	ROCHARD Mounting Frames	423
Probes, Nasal-	524	ROCHARD Retractor Blades	423
Probes, Trabecular-	521	ROCHESTER-CARMALT Hemostatic Forceps	227
PRO-MED Finger Ring Plier Saws	34	ROCHESTER-OCHSNER Forceps for BARIATRIC SURGERY	570
PRO-MED Needleholder	499	ROCHESTER-OCHSNER Hemostatic Forceps	232,570
PROVIDENCE-HOSPITAL Hemostatic Forceps	222	ROCHESTER-PEAN Forceps for BARIATRIC SURGERY	568
Pudendus Anaesthesia Needle	547	ROCHESTER-PEAN Hemostatic Forceps	228,568
Puncture Cannulas	545	ROEDER Towel Forceps	291
		ROGGE Sterilizing Forceps	298
Q		ROLLET Skin Hook	302
QUINBY Gum Scissors	121	Rongeurs, Bone for BARIATRIC SURGERY	580
QUINCKE Spinal Puncture Needles	545	ROSE Tracheal Hook	322
		ROSEN Suction Cannulas	534
R		ROSS Aorta-Retractors	383,384
Rachiotome	587	ROUX Retractor Set	330
RADOLF Nail-Extracting Forceps	33	ROUX-BABY Retractors	330
RAGNELL Retractor	321	ROUX-MINI Retractor	330
RAMEL Pleural Biopsy Needle	546	Rulers 22	
RAMPLEY Sponge Forceps	294	RUMEL Hemostatic Forceps	234
RAMSAY Dressing Forceps	145	RUSSIAN Tissue Forceps	154,566
RAMSAY Tissue Forceps	152	RUSSIAN Tissue Forceps for BARIATRIC SURGERY	566
RAMUS Retractors	376	RYDER Needleholders	499
RANDALL Kidney Stone Forceps	267	RYDER-MINI Needleholders	499
RANKIN-CRILE Hemostatic Forceps	224,567	RYDER-MINI-SELECT Needleholders	500

	Page		Page
S			
SAALFELD Comedon Extractor	31	Scissors, Transplant-	120
SACHS Dura Hook	310	Scissors, Umbilical-	116
SAENGER Ovum Forceps	287	Scissors, Vascular-	133
Safety Seals, plastic	602	Scissors, Vitrectomy-	75
Salivary Gland Sissors	123	Sclerectomy Scissors	69
SAMII Ring Tissue Forceps	188	SCOVILLE Brain Spatulas	459
SANTULLI Bulldog Clamp	214	SCOVILLE Brain-Spatula Forceps	175
SANVENERO Vascular Scissors	121	SCOVILLE Hemilaminectomy Spreader	436
SAROT Bronchus Clamps	239	SCOVILLE Nerve Root Hooks	312,313
SAROT Hemostatic Forceps	230,569	SCOVILLE-HAVERFIELD Self-Retaining Retractor	437
SAROT Hemostatic Forceps for BARIATRIC SURGERY	230	SCOVILLE-RICHTER Laminectomy-Spreader	435
SAROT Needleholders	495	Screw Depth Gauges	24
SATINSKY Blood Vessel Clamps	242	SCUDDER Intestinal Forceps	251
SATINSKY Vascular Scissors	107	SCUDDER-DEBAKEY Intestinal Clamps	259
SAUER Eye Specula	388	SCULPO Breast-Retractors	367
SAUERBRUCH Needle Case	609	Seals, Safety-	602
SAUERBRUCH Retractors	349,350	SEGOND Hysterectomy Forceps	272
SAUERBRUCH Waste Forceps	298	SEGOND-LANDAU Hysterectomy Forceps	272
Saw Blades	560	Self-Retaining Retractors	399-466
Saws, Plaster-	556	SEMB Bronchus Clamps	241
Saws, Plaster- electric	558-560	SEMKEN Dressing Forceps	143
SAWTELL Tonsil Forceps	237	SEMKEN Dressing Forceps PROMEDUR	164
SCALP-CONTOUR Retractors	393	SEMKEN Dressing Forceps TITANIUM	143
Scalpel Blades	48-50	SEMKEN Tissue Forceps	149
Scalpel Handle for Micro Blades	51	SEMM Abdominal Retractor	421
Scalpel Handles	51-56	SENN-GREEN Retractors	323
Scalpel Knives	57	SENN-MILLER Retractors	321
Scalpels	57-58	SENN-MILLER-BABY Retractors	321
Scapula Retractors	364	Separate base for MINI-Container	599
SCHAEDEL Towel Clips	290	Septum Needle	549
SCHAMBERG Comedon Extractor	31	SEUTIN Plaster Shears	138
SCHIMMELBUSCH Sterilizing Drums	607	SEXTON Self-Retaining Retractor	401
SCHINK Dermatome	62	SHAAF Foreign Body Forceps	163
SCHMID Irrigating Cannulas	536	Sharpening Stone	61
SCHMIEDEN-TAYLOR Dura Scissors	111	SHEA Multipurpose Retractor with fibre optic	381
SCHNIDT Tonsil Forceps	237	SHEA Transplant Scissors	120
SCHOEMAKER Goitre Scissors	123	SIEBENMANN Irrigating Cannulas	536
SCHOEMAKER-LOTH Ligature Scissors	117	SIEBOLD Gynecological Scissors	115
SCHROEDER Tenaculum Forceps	277,279	Silicone Pads	604
SCHUKNECHT Self-Retaining Retractors	399	Silicone Storage Strip Set	605
SCHUMACHER Umbilical Scissors	116	SILVER Dermatome	63
SCHWARTZ Applying Forceps	211	SIMON Fistula Hooks	327
SCHWARTZ Bulldog Clips	211	SIMON Scalpels	58
SCHWEIGGER Suture Forceps	200	SIMS Dissecting Scissors	114,126
Scissors, Arteriotomy-	79,80,81,87	SIMS-MAIER Polypus Forceps 28 cm cvd.	295
Scissors, Bandage-	135,136	SINGLEY (TUTTLE) Tissue Forceps	154
Scissors, Cartilage-	123	SKENE Tenaculum Forceps	279
Scissors, Coronary-	79,80,81,87	Skin Hooks	31,315
Scissors, Dissecting-	98-109,124,125-132	Skull Breakers	587
Scissors, Enterotomy-	112-113,127	SMILLIE Knee Retractors	370
Scissors, Episiotomy-	116	SMITH (US-ARMY) Gauze Scissors	136
Scissors, Eye-	66-75,89,124	SMITH Eye Specula	388
Scissors, Fine Surgical-	91-95	SMITH Wire Cutting Scissors	134
Scissors, Fistula-	95	SMITH-BUIE Anal Retractor	463
Scissors, Goitre-	123	SMITHWICK Nerve Hooks	310
Scissors, Gynecological-	114-116,125,126	SNELLEN Entropium Forceps	204
Scissors, Incision-	95	SOFIELD Retractors	331
Scissors, Ligature-	117,134	SOMER Uterine Elevating Forceps	282
Scissors, Micro-	76-89	Spatulas, abdominal	354-357
Scissors, Nasal-	118,-122,134	Spatulas, Brain-	459-460
Scissors, Nerv-	111	Spatulas, Lung-	361,363,365-366
Scissors, Neurosurgical-	111	Specula, Eye-	388-390
Scissors, Operating-	96-97,125	Specula, Rectal-	462,463
Scissors, Pituitary-	90	SPENCER Stitch Scissors	117
Scissors, Plaster-	137	SPENCER-WELLS Hemostatic Forceps	227
Scissors, Plastic Surgery-	118-122,124,134	Spermatic Cord Fixation Clamp	269
Scissors, PROMEDUR w. Tungsten-Carbide-Insterts	124-134	Spermatic Cord Hook	327
Scissors, Salivary Gland-	123	Sphygmometers	8-10
Scissors, Sclerectomy-	69	Spinal Puncture Needles	545
Scissors, Stitch and Suture-	117,134	Spiral Supports for Micro-Instruments	605
Scissors, Surgical-	98-99,125	Splinter Forceps	161-162
Scissors, Thoracic-	107	Spoon, Medicine-	611
Scissors, Tonsil-	122	St.MARKS Pelvis Retractors	360
		St.MARKS Perineal Retractor	463
		St.MARTIN Suture Forceps	198

	Page		Page
STACKE Ear Probe	524	TIEMANN Bullet Forceps	279
STAUDE-MOORE Tenaculum Forceps	276	Tissue- and Organ Holding Forceps	243-248
STEINHÄUSER Zygomatic Hooks	373	Tissue Forceps	148,150,151,566
STELZNER Rectal Scissors	113	Tissue Forceps FINO	150
Sterilizing Baskets	593,595,597,599	Tissue Forceps for BARIATRIC SURGERY	566
Sterilizing Boxes for Micro Instruments	607	Tissue Forceps USA Model	150
Sterilizing Containers	592,594,596,598,600,601,607	TOENNIS Dissecting Scissors	104
Sterilizing Containers, 1/1 size	596	TOENNIS Dura Hook	311
Sterilizing Containers, 1/2 size	596	TOENNIS Hemostatic Forceps	231
Sterilizing Containers, 3/4 size	594	TOENNIS Needleholders	492
Sterilizing Containers, Dental-	601	TOENNIS-ADSON Dissecting Scissors	104,128
Sterilizing Drapes	604	TOENNIS-RYDER Needleholders	492
Sterilizing Drums	607	TOHOKU Towel Forceps for paper drapes	291
Sterilizing Forceps	298,610	Tonsil Hemostatic and Seizing Forceps	237,238
Sterilizing Rack for 8 Micro-Instruments	606	Tonsil Needles with LL-connection	549
Sternal Puncture Needle	545	Tonsil Scissors	122
STEVENS Iris Forceps	191	Trabecular Probes	521
STEVENS Needleholders	472	Trachea Hooklets	318
STEVENS Tenotomy Hook	304	Tracheal Retractors	322
STEVENS Tenotomy Scissors	93	Transformer 220 V	20
STEVENSON Eye Specula	389	Transplant Scissors	120
STIEGLITZ Splinter Forceps	162	TRAVERS Self-Retaining Retractors	397
STILLE Dressing Forceps	144	Trays, Instrument-	612
STILLE Kidney Pedicle Forceps	266	TREVES Tissue Forceps	153
STILLE Plaster Shears	137	Trocarts	541-542
STILLE-BARRAYA Tissue Forceps	154,567	TROELTSCH Ear Dressing Forceps	189
STILLE-HAGLUND Plaster Cast Spreader	557	TROELTSCH Nasal Dressing Forceps	190
STONE Tissue Forceps	153	TROELTSCH Tampon Forceps	190
Storage Strips	605	TROEMNER Percussion Hammer	16
Strabismus Scissors	92,124	TROUTMAN Blade Breakers	64
STRANDELL-STILLE Retractors	320	TROUTMAN Corneal Scissors	73
STRATTE Needleholder	495,504	TROUTMAN Iris Forceps	194
STRINGER Forceps Holders	299	TROUTMAN-RECTUS Muscular Forceps	202
STRULLY Nerv Scissors	111	TUBING Clamps	292
Suction Cannulas, conical	535	TUEBINGEN Micro Hooks	303
Suction Dissector	536	TUEBINGEN Retractor	347
Suction Raspatory	535	TUEBINGEN Self-Retaining Retractor	410
Supports for Micro-Instruments	605	TUEBINGEN Suture Forceps	198
Surgical Scissors	98-99,124	TUFFIER Abdominal Spatula	355
Suture Forceps	507	TUFFIER Intestinal Forceps	243
Suture Sets	509-511	Tumor- and Tissue Grasping Forceps	179,184,187-188
Suture tying Forceps	160	Tumor Forceps	176
Syringes	548-552	TURNBULL Nail Nippers	28
Syringes 3 Rings Luer-Lock	549	TURNER-WARWICK Abdominal Retractor	426-428
Syringes, Dental-			
Syringes, Ear-	551		
Syringes, Flushing-	551,552		
Syringes, Wound- asnd Bladder-	550		
SYSTRUNK Nailsplitting Scissors	33		
T			
Tablet, Dish-	611		
Tape Measures	22		
TAYLOR Dressing Forceps	146		
TAYLOR Dressing Forceps TITANIUM	146		
TAYLOR Percussion Hammer	16		
TAYLOR Spinal Blades	438		
TAYLOR Spinal Hooks	309		
TAYLOR Tissue Forceps	152		
TAYLOR-CUSHING Dressing Forceps	146		
TAYLOR-CUSHING Tissue Forceps	152		
TEALE Vulsellum Forceps	281		
TEMPLE-FAY Laminectomy-Spreader	436		
Tenaculum Forceps	276-281		
Tendon Hooks	320		
TERSON Capsular Forceps	201		
THOMS-ALLIS Tissue Forceps	244		
THOMSON-WALKER Bladder Retractor	465		
Thoracic Scissors	100,107		
THOREK (HALLE) Dissecting Scissors	100		
THOREK Thoracic Scissors	100		
THORPE (Marchac) Caliper	24		
Thymus Retractors	322		
Thyroid Retractors	337,343		
U			
		UCKERMANN Cotton-Applicator	529
		ULRICH Dressing Forceps	296
		Umbilical Scissors	116
		UNIVERSAL Scissors	136
		UNIVERSAL Trocars	541
		UNIVERSAL Wire Cutting Scissors	117,134
		UNNA Comedon Extractor	31
		UNNA-VIDAL (GREG) Comedo Extractor w. Needle	31
		Ureter Forceps	268,269
		Urology Hemostats	269
		USA-MODEL Dressing Forceps	144
		USA-MODEL Tubing Clamps	292
		US-ARMY Retrators	329
		Uterine Elevating Forceps	282-283
V			
		VAN ALEYA Antrum Tocar	542
		VANNAS Iridectomy Scissors	74
		VANNAS Scissors with profile handle	86,88
		VANNAS-TUEBINGEN Cataract Scissors	74
		VARADY Phlebotomizers	544
		Varix Instruments	543-544
		Vascular Dilators	525
		Vascular Scissors	107-110,133
		VAUGHAN Pocket Abscess Knife	61
		Vein Hooks	315
		VENAE-SECTIO Set	512
		Venous Cannulas	547

	Page		Page
VERRES Pneumoperitoneal Biopsy Needles	547	Y	
VIDAL Lupus Scraper	31	YANKAUER Suction Tubes	537,577
VIENNA Suture Catcher	517	YANKAUER Suction Tubes for BARIATRIC SURGERY	577
VIRCHOW Brain Knives	60	YASARGIL Scissors with profile handle	88
VIRCHOW Cartilage Knives	60	YASARGIL Suction Tubes	532
VIRTUS (RALK) Splinter Forceps	162	YASARGIL Tumor Forceps	179
VISE Micro Tying Forceps	160	YOUNG Prostatectomy Forceps	269
VITRECTOMY Scissors	75	YOUNG Tongue Holding Forceps	36
VOLKMANN Bonehooks	335	Z	
VOLKMANN Rake Retractors	332,333,335	ZENKER Hemostatic Forceps	230
VOLLMAR Ring Strippers	543	ZENKER Retractors	353
W		ZIEGLER Eye Specula	389
WACHENFELDT Approximation Forceps	506	ZOELLNER Suction Cannulas	534
WACHENFELDT Clip-Applying Forceps	506		
WAGENER Ear Hooklets	305		
WAGNER Fine Dissecting Scissors	105		
WALDMANN Episiotomy Sissors	116		
WALKER Iris Scissors	92		
WALTON Dressing Forceps	295		
WALTON Finger Ring Saw	34		
WALTON Plaster Cast Spreader	557		
WALTON Plaster Shears	138		
WALTON Self Self-Retaining Retractors	398		
WALTON-Select Finger Ring Saw	34		
WANGENSTEEN Dressing Forceps PROMEDUR	164		
WANGENSTEEN Needleholders	494,504		
WANGENSTEEN Tissue Forceps	154		
WARTENBERG Pinwheel	17		
WASSMUND Retractor	336		
Waste Collectors, Cotton-	608		
WATSON Dermatome	63		
WAUGH Dressing Forceps	146		
WAUGH Tissue Forceps	155		
WEBER Aesthesiometer	22		
WEBSTER Needleholders	488,501		
WECKER Iris Scissors	71		
WEISS Eye Specula	388		
WEITLANER Self-Retaining Retractors	393,394		
WEITLANER-BABY Self-Retaining Retractors	393		
WERTHEIM Dissecting Scissors	100		
WERTHEIM Hysterectomy Forceps	274,272,274		
WERTHEIM Hysterectomy Forceps	270		
WERTHEIM-ATRAUMA Hysterectomy Forceps	273		
WERTHEIM-CULLEN Hysterectomy Forceps	273		
WERTHEIM-DEBAKEY Hysterectomy Camps	275		
WESTCOTT Eye Scissors	71		
WESTERMAN (Jensen) Biopsy Needles	546		
WHITE Tonsil Seizing Forceps	237		
WICKHAM Applying Forceps	215		
WICKHAM Bulldog Clamps	215		
WIENER Iris Hooks	302		
WIGMORE Plaster Saw	556		
WIJNEN Suction Tubes	538,578		
WIJNEN Suction Tubes for BARIATRIC SURGERY	578		
WIKSTROEM Hemostatic Forceps	235		
WILDE Ear Dressing Forceps	189		
WILDER Lacrymal Dilators	521		
WILLET Scalp Flap Forceps	284		
WILLIAMS Eye Specula	389		
WILLIAMS Tissue Forceps	245		
WILMER Eye Scissors	68		
WINTER Ovum Forceps	287		
Wire Basket for MINI Containers	599		
Wire Basket with lid for Dental Containers	601		
Wire Baskets for Endoscopy Containers	600		
WISCONSIN-FOREGGER Laryngoscopes	41		
WOLFF Plaster Cast Breakers	557		
WOODSON Dura-Separator	149		
WORST (Pigtail) Trabecular Probe	521		
WULLSTEIN Irrigating- & Suction Cannulas	534		
WULLSTEIN Micro Suction Tube	532		
WULLSTEIN Self-Retaining Retractors	398		

Index alphabétique**A**

AACHEN Spatules cérébrales	459
ABRAMS Aiguille à biopsie-plevre	546
ADAIR Pince utérine	277
ADAMS Bistouris	58
ADLERKREUTZ Pincés à griffes	153
ADSON Ecarteurs autostatique	394,395,404
ADSON Canules aspiratrice	531
ADSON Crochets à nerfs	309
ADSON Pincés à dissequer	142
ADSON Pincés à dissequer TITAN	142
ADSON Pincés à griffes	148
ADSON Pincés à griffes PROMEDUR	164
ADSON Pincés à griffes TITAN	148
ADSON Pincés à hypophyse	175
ADSON Pincés hémostatiques	225
ADSON Pincés pour Neurochirurgie	175
ADSON Porte-aiguilles	503
ADSON-ANDERSON Ecarteurs autostatique	395
ADSON-BABY Ecarteurs autostatique	400
ADSON-BABY Pincés hémostatiques	225
ADSON-BECKMANN Ecarteurs autostatique	404
ADSON-BROWN Pincés à griffes	153
ADSON-BROWN Pincés à griffes PROMEDUR	166
ADSON-BROWN Pincés à griffes TITAN	153
ADSON-DEBAKEY Pince à griffes	142
ADSON-GRAEFE Pince à griffes	149
ADSON-MICRO Pincés à dissequer	142
ADSON-MICRO Pincés à griffes	148
ADSON-SELECT Pince à dissection à griffes	148
AEBLI Ciseaux à kératomie	74
AEBLI Ciseaux pour la cornée	67
Aesthesiomètre	22
Agrafes, MICHEL	507
AGRICOLA Blépharostat	390
Aiguille pour amygdales raccord LL	549
Aiguille pour la cloison nasale raccord LL	549
Aiguilles à ligatures	513-515
Aiguilles à ponction	545,545
Aiguilles à suture pour autopsie	588
Aiguilles lombaire	545
Aiguilles-Guidage d'introduction pour drainage	540
ALABAMA Pince à strabisme	203
ALAN-PARKS Ecarteurs rectal	462
Algesimètres	17
ALLEN Pincés intestinales	243
ALLIS Pince intestinale pour CHIRURGIE BARIATRIQUE	572
ALLIS Pincés intestinales	243
ALLIS Pincés intestinales atraumatiques	244
ALLIS-ADAIR Pincés intestinales	244
ALLIS-BABY Pincés intestinales	243
ALLISON Valves à poumon	363
ALLPORT Crochets auriculaires	305
ALLPORT Ecarteur autostatique	392
ALM Ecarteurs autostatique	391,392
ALY Instrument pour sensibilité	17
Amygdales, Ciseaux-	122
Anatomie, Ciseaux-	93
ANDERSON-ADSON Ecarteurs autostatique	395
Anesthésie	35-46
ANVIL Pince à ongles	33
Appareils pour mesurer vis	24
ARKANSAS Pierre à aiguiser	61
ARRUGA Blépharostats	388
ARRUGA Pincés capsulaires	201
ARRUGA Portes-aiguilles	471
ARRUGA Portes-aiguilles PROMEDUR	471
ARTHUR Pince à échardes	162
Attache de fixation pour Séparateurs	606
Attaches de fixation pour les instruments	606
AUFRANC-COBRA Leviers à os	369

AUFRICHT Ciseaux nasaux	119
AUFRICHT Crochets pour les ailes du nez	307
Auriculaire, Crochets-	305
AUSTIN Pincés à ligatures	160
AUTOFILL Seringue à irrigation	551
Autopsie	583-588
Autopsie Boite à Instruments	584
AXENFELD Ecarteurs fins	303
AYER Pincés à chalazion	206

B

BABCOCK Pince intestinale pour CHIRURGIE BARIATRIQUE	573
BABCOCK Pincés intestinales	245,246,573
BABCOCK Pincés intestinales PROMEDUR	246
BABCOCK-DEBAKEY Pincés intestinales	246
BABINSKY Marteau à percussion	16
BABY-ADSON Ecarteurs autostatique	400
BABY-ADSON Pincés hémostatiques	225
BABY-ALLIS Pincés intestinales	243
BABY-BALFOUR Ecarteur abdominal	415
BABY-COLLIN Ecarteur abdominal	411
BABY-CRILE Pincés hémostatiques	222
BABY-CRILE-WOOD Portes-aiguilles	489
BABY-INGE Ecarteurs à corps vertebraux	443
BABY-KOCHER Pincés intestinales	249
BABY-MIXTER Pincés hémostatiques	235
BABY-ROUX Ecarteurs	330
BABY-SENN-MILLER Ecarteurs	321
BABY-WEITLANER Ecarteur autostatique	393
BACKHAUS Pincés à champs	290
BADGLEY Ecarteur pour laminectomie	434
Bagues, scies à-	34
BAINBRIDGE Pincés hémostatiques	227
BAKES Dilatateurs à voix viliaires	528
BALFOUR Bras latéral	417
BALFOUR Ecarteurs abdominaux	415-417
BALFOUR-BABY Ecarteur abdominal	415
BALL et SOCKET Pincés à champs	291
BALLENGER Pincés à amygdales	238
BALLENGER Pincés à éponges	293
Bandes porte instruments, Silicone	605
BANDIT-LEKSELL Pincés-gouge pour CHIRURGIE BARIATRIQUE	580
BARON Canules aspiratrice	535
BARR Ecarteur rectal	463
BARRAQUER Blépharostats	388
BARRAQUER Ciseaux à iridectomie	71
BARRAQUER Ciseaux pour la cornée	71
BARRAQUER Pince à épiler	163
BARRAQUER Pince à fixation	196
BARRAQUER Pincés à chambre antérieure	202
BARRAQUER Pincés à sutures	194,199
BARRAQUER Portes-aiguilles	472,473
BARRAQUER Portes-lames	64
BARRAQUER-COLIBRI Pince à fixation	194
BARRAQUER-KATZIN Pincés à Iris	194
BARRAQUER-TROUTMAN Portes-aiguilles	472
BARRET Pince utérine	276
BARRON Manche à bistouri	54
BARSKY Crochet à peau double	307
Bassins reniformes	610
BAUER Ecarteur Ecarteurs intra oraux av. fibre optique	378
BAUER Ecarteurs intra oraux	378
BAUMGARTNER Portes-aiguilles	488,501
BECKMAN Ecarteur autostatique	403
BECKMAN-EATON Ecarteurs autostatiques	403
BECKMANN-ADSON Ecarteurs autostatiques	404
BECKMANN-WEITLANER Ecarteurs autostatiques	402
BEEBEE Ciseaux à fils	117
BEER Pincés à épiler	163
BEESON Ecarteur à plâtre	557
BENGOLEA Pincés hémostatiques	226
BERENS Pince-clamp musculaire	205
BERGH Pincés à épiler	163
BERGMANN Ciseaux à pansements	136
BERGMANN Crochet	315

	Page		Page
BERGMANN Scie à main à plâtre	556	BUNT Epingle à instruments	299
BERGMANN-FOERSTER Pincés à éponges	293	Burins casse-crâne	587
BERKE Pincés musculaires	205	BUSCH Ciseaux pour le cordon ombilical	116
BERLINER Marteaux à percussion	16		
BERNHARD Pincés à champs	291	C	
BERRY STERNAL Porte-aiguilles	492	Cables d'alimentatin pour les pincés bipolares	172
BERTILLON Céphalomètre	23	Cadres fixe-toiles	593,595,597,599,601
BEST Pincés intestinales	253	CANNY-RYALL Ecarteurs	329
BIEMER Ciseaux pour venes	83,88	Canule laryngienne raccord LL	549
BIRKETT Pincés à amygdales	238	Canule pour anesthésie transvaginale	547
BISHOP-HARMAN Pincés à Iris	192	Canule pour lavage	542
Bistouris	57-58	Canules à lavage pour nez et sinus macillaire	535
Bistouris, Manches à-	50-56	Canules aspiratrice	530-539
BLAKE Pincés pourcalcules bilaires	264	Canules aspiratrice conique	535
BLANK Pincés à dissequer atraumátiques	144	Canules aspiratrice malleables	530
BLASCOVICS Pincés musculaires	205	Canules avec olive	547
Blépharostats	388-390	Canules pour Heparin	547
BLESSING Ciseaux pour chirurgie rectale PROMEDUR	127	Canules pour insufflation	122
BLOHMKE Pincés à amygdales	238	CAPLAN Ciseaux nasaux	161
BLOUNT Ecarteur pour Menisque	370	CARMALT Pince à échardes	220
BOETTCHER Ciseaux pour les amygdales	122	CARREL Pince hémostatique	22
Boîtes à aiguilles	608,609	CARROL Goniomètre	445-448
Boîtes à instruments	612	CASPAR Ecarteurs à corps vertebraux	449,450,451
Boîtes à Stérilisation	592-601,607	CASPAR Contre-Ecarteurs	451,452
Boîtes à Stérilisation pour Micro Instrumets	607	CASPAR Distracteurs vertebraux	340
Boîtes rondes à Stérilisation	607	CASPAR Ecarteur	450-453
BONACCOLTO Pincés à strabisme	203	CASPAR Ecarteurs pour la Micro Dissectomie lombaire	451,452
BONACCOLTO Pincés à sutures	200	CASPAR Guides-forets	451,452
BONN Ciseaux à Iris	67	CASPAR Guides-Mêche	453
BONN Ciseaux à Strabisme	67	CASPAR Mêche	449,450
BONN Crochets à Iris	303	CASPAR Spéculum pour chirurgie lombaire	450
BONN Pincés à Iris	193	CASPAR Spéculum pour la hypophysectomie	453
BONN Pincés à sutures	198	CASPAR Tourne-Vis	453
BONNEY Pincés à dissequer	145	CASPAR Vis à distraction	389
BONNEY Pincés à Griffes	153	CASTROVIEJO Blépharostat	72,74
BONNEY Pincés à Griffes PROMEDUR	165	CASTROVIEJO Ciseaux pour la cornée	72
BONNEY Pincés à Griffes PROMEDUR	166	CASTROVIEJO Ciseaux pour la synécchie antérieure	23
BOROWSKI Ecarteurs pour atrium	382	CASTROVIEJO Compas	201
BOSE Ecarteur autostatique pour tracheotomie	391	CASTROVIEJO Pince capsulaire	198
BOWMAN Blépharostat	388	CASTROVIEJO Pincés à sutures	470
BOWMAN Ciseaux boutonées	107	CASTROVIEJO Portes-aiguilles	470
BOWMAN Sondes boutonées	520	CASTROVIEJO Portes-aiguilles PROMEDUR	64
BOWMAN Sondes cylindriques	520	CASTROVIEJO Portes-lames	521
BOYNTON Porte-aiguilles	470	CASTROVIEJO Stylet Dilatateur	473
BOYS-ALLIS Pincés intestinales	244	CASTROVIEJO-MICRO Portes-aiguilles	59
BOZEMANN Ciseaux utérins	115	CATLIN Couteaux à amputation	327
BOZEMANN Pince porte-éponges	297	Ccochet à cordon spermatic	23
BOZEMANN Portes-aiguilles	493	Céphalomètre	604
BOZEMANN-DOUGLAS Pince porte-éponges	297	Champs à stérilisation	290-291
BRAUN Pince utérine	276	Champs, Pincés à-	243
BRAUN-STADLER Ciseaux à épisiotomie	115	CHAPUT Pince intestinale	429
BRIDGE Pincés hémostatiques	227	CHARNLEY Ecarteur abdominal	401
BROM Crochets pour veines	315	CHARNLEY Ecarteur horizontal	298
BROMPTON Pince à drainage	292	CHEATLE Pincés à stérilisation	297
BROPHY Ciseaux à dissection	121	CHERON Pince porte-éponges	606
BROPHY Pincés à dissequer	144	Chevalet à stérilisation pour Micro instruments	506
BROPHY Pincés à griffes	151	CHILDE Pincés à poser et enlever agrafes	563-580
Brosses à main	30	CHIRURGIE BARIATRIQUE	587
Brosses, distributeurs à-	30	Cinzel pour autopsie	136-138
BROWN Pincés à griffes	154	Cisailles à plâtre	33
Brucelles	173-174	Cisais à fendre les ongles	91,97,101,120
BRUNETTI Ciseaux-burin pour l'ouverture de l a colonne	587	Cisais pour gauchers	122
BRUNNER Aiguilles à ligatures	515	Cisais pour les amygdales	104-106119-121,130-134
BRUNNER Ecarteurs	351,352	Cisais fins à dissection	65-137
BRUNNER Guides-fils	517	Ciseaux	30
BRUNNER Pincés intestinales	253	Ciseaux & Lime à ongles & chain	122,123
BRUNS Cisailles à platre	138	Ciseaux à amygdales	93
BRYANT Pincés à tampons	295	Ciseaux à Anatomie	79-81,87,108
BÛCHS Ecarteur à joues	375	Ciseaux à Arteriotomie	116
BUCK Ciseaux à sutures	117	Ciseaux à détroncation	94,98-107,120,124-132
BUCK Marteau à percussion	16	Ciseaux à dissection	112-113
BUIE Pince à pression	261	Ciseaux à Enterotomie et à rectum	69
BUIE Sonde à fistules	526	CISEAUX à énucléation	28
BULLDOG Clips pour arteria et vena	216		
BUMM Pince à polypes uterine	286		

	Page		Page
Ciseaux à episiotomie	115,116	COLLIN Pince à enlever agrafes	507
Ciseaux à gynécologie	98-100,114-116,125,126	COLLIN Pince à polypes	297
Ciseaux à Hypophysectomie	90	COLLIN Pince intestinale	247
Ciseaux à Incision	95	COLLIN Pince tire-langue	36
Ciseaux à Iridectomie	68,91,92	COLLIN Pincés Hystérolabe	282,283
Ciseaux à Iridectomie avec anneaux larges	92	COLLIN-BABY Ecarteur abdominal	411
Ciseaux à Iridectomie pour GAUCHERS	91	COLLIN-DUVAL Pincés à intestins	156
Ciseaux à Iridectomie SUPERCUT	91,92	COLLIN-HARTMANN Ecarteurs	330
Ciseaux à Ligatures	117-118,134	COLLIN-LOCKTITE Ecarteur abdominal	412
Ciseaux à Lobectomie	107,113,115	COLLYER Compas pelvimètre	25
Ciseaux à Neurochirurgie	111	COLVER Pincés à amygdales	238
Ciseaux à Ongles	28,33	CONE Ecarteurs autostatique	397
Ciseaux à Pansements	135-136,138	Containers plats à stérilisation	598
Ciseaux à Plâtres	136-137	Containers pour Endoscopie	600
Ciseaux à Strabisme	92	CONTOUR Ecarteurs autostatique	400
Ciseaux à Strabisme SUPERCUT	92	CONVERSE Ecarteur nasal	308
Ciseaux à Transplantations	120	CONVERSE-ALAR Ecarteur	308
Ciseaux avec manche "Profil"	85-88	COOK Blépharostats	390
Ciseaux Coronaires	79-81,87,108,109	COOLEY Aspirateurs pour CHIRURGIE BARIATRIQUE	578
Ciseaux délicats	91-96,100,104-111,119-121,124,128	COOLEY Ecarteurs pour atrium	383
Ciseaux nasaux	118-122,134	COOLEY Pincés vasculaires	158
Ciseaux nasaux PROMEDUR	134	COOLEY Pincés vasculaires TITAN	158
Ciseaux oculaires	66-75,91-93,124	COOPER Aiguille à ligatures	515
Ciseaux opératoires	94-97,125	COPE Ecarteur	322
Ciseaux opératoires	93-97	CORN Pince à sutures	507
Ciseaux opératoires pour GAUCHERS	97	COTTLE (Millard) Crochet nasal	308
Ciseaux opératoires PROMEDUR	125	COTTLE Alar Ecarteur	308
Ciseaux opératoires fins	93-97	COTTLE crochets fins	306
Ciseaux opératoires SUPERCUT	97	COTTLE Crochets pour les ailes du nez	307
Ciseaux pour Cartilage	122	COTTLE Ecarteurs	307
Ciseaux pour Chirurgie rectale	127	COTTLE Pince à columnella	190
Ciseaux pour Enterotomie	112	COTTLE Pince à fixation	190
Ciseaux pour Gencive	105,106,124,134	COTTLE-BULLDOG Ciseaux nasaux	118
Ciseaux pour Goitre	123	COTTLE-DORSAL Ciseaux nasaux 15 cm	118
Ciseaux pour Hypophysectomie	75	COTTLE-MASING Ciseaux nasaux	119
Ciseaux pour la Chirurgie plastique	104-106,119-121,134	COUPE à comprimes	611
Ciseaux pour la Dura Mère	111	COUPLAND Canule aspiratrice	537
Ciseaux pour la Vena Cava	107	Couteau à phalanges	59
Ciseaux pour le Cartilage	123	Couteaux à amputation	59,60
Ciseaux pour le Poumon	107,564	Couteaux à cartilage	60
Ciseaux pour le Poumon pour la CHIRURGIE BARIATRIQUE	564,565,566	Couteaux à plâtre	556
Ciseaux pour Microchirurgie	76-90	Couteaux cérébraux	60
Ciseaux pour Nerves	111	COX Ecarteur autostatique pour doigts et orteils	393
Ciseaux pour Rectum	112,113	CRAFOORD Ciseaux pour la CHIRURGIE BARIATRIQUE	564
Ciseaux pour Rectum PROMEDUR	127	CRAFOORD Ciseaux pour le poumon	107
Ciseaux pour section du Cordon	115,116	CRAFOORD Clamps bronchiques	229
Ciseaux pour Veines	83,88	CRAFOORD-SELLORS Clamp pour CHIRURGIE BARIATRIQUE	569
Ciseaux pour Voie Salivaire	123	CRAFOORD-SELLORS Clamps bronchiques	229
Ciseaux universelles	136	CRAWFORD Ecarteurs	384
Ciseaux utérins	100	CRILE Crochets à nerfs	309
Ciseaux valculaires	107-110,133	CRILE Pincés hémostatiques	222
Ciseaux vasculaires boutonnés	107	CRILE Pincés hémostatiques TITAN	222
Clamps bronchiques	229	CRILE Porte-aiguilles	502
CLAR Eclairés frontaux	20	CRILE-BABY Pincés hémostatiques	222
CLARKE Spécium-Blépharostat	388	CRILE-MURRAY Porte-aiguilles	502
CLOWARD Crochets à dure-mère	311	CRILE-RANKIN Pincés hémostatiques	224
CLOWARD Ecarteurs à corps vertébraux	443	CRILE-WOOD Portes-aiguilles	489,502,576
CLOWARD Ecarteurs pour colonne cervicale	430,431	CRILE-WOOD Portes-aiguilles pour CHIRURGIE BARIATRIQUE	576
CLOWARD Ecarteurs spinaux	309	CRILE-WOOD-BABY Portes-aiguilles	489
CLOWARD-CONTOUR Ecarteurs autostatique	400	CRITCHETT Blépharostat	388
CLOWARD-HOEN Ecarteur pour colonne cervicale	432	Crochet musculaire pour autopsie	587
COAGULATION bipolaire, Pincés-	167-171	Crochet pour os	335
COAKLEY Trocart pour sinus maxillaire	542	Crochets / Ecarteurs pour l'ophtalmologie	302-304
COBBETT Dermatome	63	Crochets à crypte	526
COHAN Portes-aiguilles	472	Crochets à dure-mère	311
COHAN-VANNAS Ciseaux pour la cataracte secondaire	74	Crochets à iris	302-304
COHEN Pince à envies	29	Crochets à nerfs	309-315
COLLER-CRILE Pince hémostatique pour CHIRURGIE BARIATRIQUE	567	Crochets à peau	31,303,315
COLLER-CRILE Pincés hémostatiques	224	Crochets à strabisme	304
COLLIER Porte-aiguilles	501	Crochets auriculaires	305
COLLIN Compas pelvimètre	25	Crochets double pour la peau	303
COLLIN Dynamomètre	22	Crochets fins pour la peau	315
COLLIN Ecarteurs	329	Crochets forts pour os	368
COLLIN Ecarteurs abdominaux	411	Crochets pour fistules	327
COLLIN Manches à bisturis	53,55	Crochets pour Rhinologie	306-308

	Page		Page
Crochets pour veines	315	DERF Portes-aiguilles	488,501
Crochets pour zygoma	381	Dermatologie	31-34
CUILLERE à médecine	611	Dermatomes	62,63
Curettes pour les lupus	32	DERMOT PIERSE Pincés à fixation	195
Curettes pour os pour CHIRURGIE BARIATRIQUE	579	D'ERRICO Ecarteurs pour racines nerveuses	314
CUSHING Spatules cérébrales	460	DESCHAMPS Aiguilles à ligatures	514
CUSHING Crochets à dure-mère	311	DESJARDINS Explorateur à calculs biliaires	527
CUSHING Crochets à nerfs	310	DESJARDINS Pincés à canal biliaire	262
CUSHING Ecarteur à décompression	314	DESJARDINS Pincés pour calculs biliaires	264
CUSHING Ecarteur pour CHIRURGIE BARIATRIQUE	574	DESMARRES Pincés à chalazion	206
CUSHING Ecarteurs	324	DESMARRES Releveurs de paupières	304
CUSHING Ecarteurs à nerfs	326	Diagnostic	8-20
CUSHING Pincés à dissequer	145	DICK Clamps-Compression	271
CUSHING Pincés à griffes PROMEDUR	164	DIEFFENBACH Clips Bulldog	210
CUSHING Spatules cérébrales	460	DIETRICH Portes-aiguilles	500
Cuvettes	610	DIETRICH Clamps Bulldog	214
CZERNY Ecarteur	331	Dilatateurs à voies biliaires	528
CZERNY Pince utérine	276	Dilatateurs pour le canal lacrymal	520,521
		Dilatateurs vasculaires	525
D		DINGMAN Crochets pour zygoma	381
DALE Pince-Gouge costale pour CHIRURGIE BARIATRIQUE	580	Dissecteurs pour phlébite	544
DANDY Ciseaux à dure-mère	111	Distributeur à filtres	603
DANDY Crochets à nerfs	310	Distributeurs pour brosses	30
DANDY Pincés hémostatiques	223	Distributeurs de coton	608
DANDY-MOSQUITO Pincés hémostatiques	223	DOCKHORN Ecarteurs à joues	373
DARLING Ecarteurs autostatique	407	DOUGLAS Pincés à épiler	163
DARTIGUES Pince Hysterolabe	283	DOUGLAS Trocart pour sinus maxillaire	542
DASTOOR Pincés à strabisme	203	DOYEN Ciseaux pour Gynecologie	115
DAVIDSON Ecarteurs à scapula	364	DOYEN Ecarteur	345
DAVIS Spatules cérébrales	459	DOYEN Pince à polypes	265
DAVIS Pincés à stérilisation	298	DOYEN Pincés à champs	290
DAY Crochets auriculaires	305	DOYEN Pincés intestinales	249
DEAN Ciseaux pour les amygdales	122	DOYEN Porte-aiguilles	501
DEAVER Ciseaux opératoires fins	94	DOYEN Sonde cannelée	523
DEAVER Ecarteurs	357-359,574	DOYEN Spatules abdominaux	424
DEAVER Ecarteurs pour CHIRURGIE BARIATRIQUE	574	DOYEN-DEBAKEY Pincés intestinales	255
DEAVER Ecarteurs pour CHIRURGIE BARIATRIQUE	574	DOYEN-STILLE Ecarteurs	345
DEBAKEY Aspirateurs	538,578	DUBOIS Ciseaux à détroncation	116
DEBAKEY Aspirateurs pour CHIRURGIE BARIATRIQUE	578	DUEHRSEN Pince à dissequer	145
DEBAKEY Ciseaux à dissection	104	DUEHRSEN Pince à griffes	152
DEBAKEY Ciseaux vasculaires	109	DUNHILL Pincés hémostatiques	222
DEBAKEY Ciseaux vasculaires PROMEDUR	133	DUPLAY Pince utérine	278
DEBAKEY Clamps Bulldog	217,218	DUPLAY Pincés à polypes	296
DEBAKEY Femur Ecarteurs autostatique	407	DUPLEX DE LUXE Stéthoscope	18
DEBAKEY Pince vasculaire pour CHIRURGIE BARIATRIQUE	567	DUPLEX Stéthoscope	18
DEBAKEY Pince vasculaires à griffes PROMEDUR	165	DURANTE Pincés pour vaisseaux	155
DEBAKEY Pincés Ovalaires	248	DURANTE Pince pour vaisseaux	155
DEBAKEY Pincés vasculaires	157,158,165,567	DUVAL Pincés à intestins	156
DEBAKEY Pincés vasculaires pour CHIRURGIE BARIATRIQUE	567	DUVAL Pincés intestinales	247
DEBAKEY Pincés vasculaires TITAN	157,158	DUVAL Pincés intestinales PROMEDUR	247
DEBAKEY Portes-aiguilles pour CHIRURGIE BARIATRIQUE	490	Dynamomètre	17,22
DEBAKEY Portes-aiguilles PROMEDUR	490		
DEBAKEY Sondes-Dilatateurs vasculaires	525	E	
DEBAKEY-BABCOCK Pincés intestinales	246	Ecarteur autostatique vasculaire	409
DEBAKEY-CAROTID Clamp Bulldog	219	Ecarteur pelviens	360
DEBAKEY-DOYEN Pincés intestinales	255	Ecarteur pour genou	370
DEBAKEY-FEHLAND Pincés intestinales	257	Ecarteur pour I.M.A.	461
DEBAKEY-GERALD Pince à dissequer	145	Ecarteurs à joues	373,375
DEBAKEY-HAYES Pincés intestinales	257	Ecarteurs à main	302-384
DEBAKEY-HEPARIN Canules	547	Ecarteurs à Mammoplastie	367
DEBAKEY-KOCHER Pincés intestinales	256	Ecarteurs à trachéotomie	322
DEBAKEY-MICRO Clamps Bulldog	217	Ecarteurs abdominaux	411-429,439-441
DEBAKEY-Micro Pincettes à manches ronds	185	Ecarteurs autostatiques	388-466
DEBAKEY-Micro Pincettes à manches ronds TITAN	185	Ecarteurs autostatiques horizontal	401
DEBAKEY-SATINSKY Clamps Bulldog	219	Ecarteurs autostatiques pour doigts et orteils	393
DEBAKEY-SCUDDER Pincés intestinales	259	Ecarteurs en forme de selle	324-326
DEBAKEY-SELECT Portes-aiguilles	491	Ecarteurs extra oraux	380,381
DEBAKEY-WERTHEIM Pincés à Hystérectomie	275	Ecarteurs fins à griffes	318,319
DEJERINE Marteaux à percussion	16	Ecarteurs fins à griffes flexible	318
DEMARTELL Ciseaux vasculaires	110	Ecarteurs intra oraux	378,379
DENIS- BROWNE Pincés pour vaisseaux	156	Ecarteurs pour atrium	382-385
DENIS-BROWN Ecarteurs abdominaux	418	Ecarteurs pour CHIRURGIE BARIATRIQUE	574-575
Dental Containers à stérilisation	601	Ecarteurs pour chirurgie lombaire	446
DENTAL Seringues à carpules	552	Ecarteurs pour chirurgie maxillo-facial	371,372

	Page		Page
Ecarteurs pour colonne cervicale	447-450	FOURCHE à fils	517
Ecarteurs pour corps vertebraux	442-445	FOX Curettes pour les lupus	32
Ecarteurs pour laminectomie	430-438	FRANKLIN-SILVERMAN Aiguilles à biopsie	546
Ecarteurs pour l'aorta	382-385	FRAZIER Aiguilles ventriculaires	531
Ecarteurs pour Menisque	370	FRAZIER Canules aspiratrice	533
Ecarteurs pour Micro Dissectomie lombaire	451-453	FRAZIER Canules aspiratrice isolé	533
Ecarteurs pour os	368	FRAZIER Crochets à dure-mère	311
Ecarteurs pour racines nerveuses	312	FREER Crochet pour la muqueuse	306
Ecarteurs rectaux	463-464	FRIEDMANN (Joll) Ecarteur autostatique	407
Ecarteurs spinaux	309	FRITSCH Ecarteurs	347
Ecarteurs vésicaux et à prostate	465-466	FUCHS Pince capsulaire	201
ECcarteur à joues mobile	373	FUCHSIG Pincés hémostatiques	226
EICKEN-KILLIAN Canules aspiratrice	535	FUKUSHIMA Canules aspiratrice malleables	530
EISELSBERG Ciseaux à sutures	117		
ELSCHNIG Pince à fixation	196	G	
ELSCHNIG Pince capsulaire	201	GARRETT Sondes-Dilatateurs vasculaires	525
EMMET Crochets pour fistules	327	GAUSS Pince pour le cuir chevelu	284
EMMET Pince à pansement et à éponges	296	GELPI Ecarteurs autostatiques	408,409
Endospéculum	466	GELPI-BABY Ecarteur	408
ENGEL Scie à main à plâtre	556	GELPI-MINI Ecarteur	408
Enterotomie, Ciseaux-	112	GELPI-ORTHO Ecarteur autostatique	409
Envies, Ciseaux à-	28,33	GELPI-SELETZ Ecarteur autostatique	409
Envies, Pincés à-	28,29	GEMINI Pince hémostatique pour CHIRURGIE BARIATRIQUE	571
Epicardial Ecarteurs autostatiques	392	GEMINI Pincés hémostatiques	234
EPISKLERAL Pince	197	GEMINI-MINI Pincés hémostatiques	234
Eponges, pincés à-	293-297	GERALD Pince à griffes TITAN	151
ERHARDT Pince à entropion	204	GERALD Pincés à dissequer	145
ESMARCH Cisailles à plâtre	136	GERALD Pincés à dissequer TITAN	145
ESMARCH Couteau à plâtre	556	GERALD Pincés à griffes	151
Etiquettes d'identification en papier	602	GERALD Pincés à griffes PROMEDUR	165
Etriers pour instruments	299	GEUDEL-NEGUS Laryngoscopes	42
EWALD Pince à dissequer	142	GILL Pincés à Iris	193
EXACTA Tensiomètre	9	GILL-HESS Pincés à Iris	193
Explorateur à calculs biliaires	528	GILLIES Crochet à nerfs	315
		GILLIES Crochets à peau	31,315
F		GILLIES Pincés à griffes	149
FAHLBUSCH Micro Ciseaux	90	GILLIES Pincés à griffes PROMEDUR	165
FARABEUF Ecarteurs	328	GILLIES Pincés à griffes TITAN	149
FARRELL Portes-coton	529	GILLIES Portes-aiguilles	498,505
FAURE Pincés péritoine	270	GILLIES-MINI Portes-aiguilles	498,505
FAVALORO Ciseaux vasculaires	109	GIL-VERNET Ecarteurs malleables	325
FEHLAND Pincés intestinales	253	GLASSMANN Pincés atraumatiques	159
FEHLAND-DEBAKEY Pincés intestinales	257	GLOVER Clamps Bulldog	212
FEILCHENFELD Pincés à échardes	161	Gobelets à medicine	611
FELDHEIM Compresseur pour doigts	32	Gobelets gradués	609
FERGUSON Canules aspiratrice	533	GOELET Ecarteur	331
FERGUSON Canules aspiratrice isolé	533	GOLDMAN-FOX Ciseaux pour gencive	105
FERGUSON Ciseaux pour Gynecologie	115	GOLDMAN-FOX Ciseaux pour gencive PROMEDUR	124
FERGUSSON Pincés à pression	261	GOLDMAN-FOX Ciseaux pour gencive SUPERCUT	105
FERRIS-SMITH Pincés à griffes	151	GOLDSTEIN Blépharostats	390
FERROZELL Guides-fils	517	Goniomètres	22
Fils, Ciseaux-	117	GOOD Ciseaux pour les amygdales	122
Filtres, papier	603,604	GORNEY (Killian) Ciseaux nasaux	122
Filtres, textile	604	GORNEY Ciseaux pour chirurgie plastique	106
FINK Ecarteur fin	302	GORNEY Dissecteur à aspiration	536
FINOCCHIETTO Pince à bronches	239	GOSSET Ecarteurs abdominaaux	414
FINOCCHIETTO Portes-aiguilles	493,503	GRADLE Ciseaux à sutures	117
FINSEN Ecarteurs autostatique	391	GRAEFE Blépharostats	388
FISCH Canules aspiratrice	531	GRAEFE Ciseaux oculaires	68
FISH Sondes auriculaires	524	GRAEFE Crochets à iris	303
FISHER-ARLT Pincés à Iris	191	GRAEFE Crochets à iris	302
Fixe-filtres pour containers	603	GRAEFE Crochets à strabisme	304
FLAGG Brucelles	174	GRAEFE Pincés a fixation	196
FLETCHER (Javerts) Pincés à éponges	294	GRAEFE Pincés à Iris	191
FLETCHER Pincés à éponges	294	GRAEFE Pincés à Iris	140
FOERSTER Ecarteur abdominal pour rayons-X	425	GRAEFE Pincés à Iris à griffes	147
FOERSTER Pince à éponges pour CHIRURGIE BARIATRIQUE	573	GRAEFE Pincés à Iris TITAN	140
FOERSTER Pincés à éponges	293,294,573	GRAEFE-SELECT Pincés à Iris	140
FOERSTER Pincés à Iris	192	GRAEFE-SELECT Pincés à Iris à griffes	147
FOMON Ciseaux nasaux	118	GRAHAM Crochets à nerfs	309
FOMON Ecarteurs	307	GRAY Pincés à canal biliaire	263
FOMON-DORSAL Ciseaux nasaux	118	GRAZIL Ciseaux operatoires fins	96
Fond du crible pour MINI-Container	599	GREEN Crochet à strabisme	304
FOSTER-GILLIES Portes-aiguilles	497	GREEN Ecarteur	343

	Page		Page
GREEN Pincés à fixation	196	I	
GREEN-ARMYTAGE Pincés à préhension	284	I.M.A Mammaria Ecarteur autostatique	461
GREGORY Clamps Bulldog	213	ILIC Pince à envies	29
GREGORY Micro Portes-aiguilles	482	Incision, Ciseaux-	95
GROSS Pincés à polypes	296	INFANT Stylet Dilatateur	521
GRUENWALD (Jansen) Pincés nasales	190	INGE Ecarteurs à corps vertébraux	444
GUILLEN Rugine-raspatoir à aspiration	535	INGE-BABY Ecarteurs à corps vertébraux	443
GUILFORD Ciseaux à fils, noir	117	Instruments de Mesure	22-25
GUNNAR-HEY Pince à drainage	292	Instruments, étriers pour-	299
GUTHRIE Crochets à fixation	302	INTRACARDIAC Portes-aiguilles	492
GUYON Pincés renaux	266	IOWA Pince porruption les membranes	285
GUYON Pincés renaux pour CHIRURGIE BARIATRIQUE	571	ISRAEL Ecarteurs	337
H		J	
HABERER Spatules abdominales	355	JACKSON Ecarteurs à trachéotomie	322
HALSEY Micro Portes-aiguilles	488,501	JACKSON-BURROWS Ecarteur autostatique	409
HALSEY-MICRO Portes-aiguilles	488	JACOBS Pince utérine	280
HALSTED Pincés hémostatiques	225	JACOBSON Ciseaux à Microchirurgie	82
HARMS Sondes trabeculaire	521	JACOBSON Micro Portes-aiguilles	481
HARRINGTON Ecarteurs	361	JACOBSON-ADSON Pincés à dissection	176
HARRINGTON Pincés à bronches	239,572	JACOBSON-MICRO Pincés à dissection	176
HARRINGTON Pincés à bronches pour CHIRURGIE BARIATRIQUE	572	JACOBSON-MICRO Pincés hémostatiques	221
HARRISON Pincés à stérilisation	298	JAEGER Crochets à strabisme	304
HARTMANN Canules aspiratrice	535	JAMESON Ciseaux fins à dissection	104
HARTMANN-MICRO Pincés hémostatiques	220	JAMESON Crochet à Strabisme	304
HARVEY Ciseaux à fils	117	JAMESON Pied à coulisse	24
HARVEY-JACKSON Ecarteur autostatique	405	JAMESON Pincés musculaires	204
HAYES-DEBAKEY Pincés intestinales	257	JAMESON-WERBER Ciseaux fins à dissection	104
HEANEY (Hegar) Porte-aiguilles	504	JANET Seringues	550
HEANEY Ecarteurs	362	JANSEN Ecarteurs autostatiques	392
HEANEY Pincés à Hystérectomie	272	JEFFERSON Pince à dissequer	143
HEANEY Portes-aiguilles	494,504	JEFFERSON Pince à griffes	149
HEANEY-KANTER Pincés à Hystérectomie	272	JOBSON-HORNE Portes-coton	529
HEANEY-REZAK Pincés à Hystérectomie	272	JOERGENSEN Ciseaux à dissection	99
HEATH (HUNT) Pince à chalazion	207	JOHN-HOPKINS Clamps Bulldog	210
HEGEMANN Ciseaux vasculaires	108	JOHN-HOPKINS Pince à appliquer Clamps Bulldog	210
HEGENBARTH Pince à poser agrafes	506	JOHN-HOPKINS Pincés à canal biliaire	263
HEIFETZ Micro Pincette mors circulaire, strié	187	JOLL (Friedmann) Ecarteur autostatique	407
HEIFETZ Pince a tumeur 22 cm Ø 5 mm	179	JONES Pincés à champs	290
HEIFETZ Pince à tumeurs	179	JOSEPH Ciseaux p. la chirurgie plastique	121
HEIFETZ Spatules cérébrales	459	JOSEPH Ciseaux p. la chirurgie plastique SUPERCUT	121
HEISS Pincés hémostatiques	226	JOSEPH Crochets fins	306
HENLEY Ecarteurs autostatiques	410	JUDD-ALLIS Pincés intestinales	244
HENNING Ecarteur à plâtre	557	JUDD-MASON Ecarteurs vésicaux	464,465
HENROTIN Pince utérine	280	JULIAN Portes-aiguilles	491
HENRY Pincés à épiler	163	K	
HERMANN Ecarteur à plâtre	557	KADER Spatules abdominales	354
HERRICK Pincés renaux	266	KALT Pince capsulaire	201
HERTZLER Ecarteur abdominal	415	KALT Portes-aiguilles	471
HESS Pincés à Iris	194	KALT Portes-aiguilles PROMEDUR	471
HESS Pincés à sutures	201	KALT-ARRUGA Portes-aiguilles	471
HEYMANN Ciseaux nasaux	118	KANTROWITZ Pincés hémostatiques	234
HEYWOOD-SMITH Pincés à polypes	285	KATSCH Tire-Comedon	31
HIBBS Ecarteurs spinaux	362	KATZIN Ciseaux pour la cornée	73
HIBBS Valves pour ecarteurs	438	KATZIN-BARRAQUER Ciseaux pour la cornée	73
HOEN Crochets à nerfs	309	KAYE Ciseaux à transplantations	120
HOEN Ecarteurs pour colonne cervicale	432	KAYE Portes-aiguilles	498
HOESEL Ecarteurs	346	KELLY Ciseaux opératoires fins	95
HOLSCHER Crochets à nerfs	313	KELLY Ciseaux opératoires fins SUPERCUT	95
HOLTZHEIMER Ecarteurs autostatique	392	KELLY Ecarteurs	344
HOLZBACH Ecarteur abdominal	413	KELLY Pincés à faux germe	287
HOPKINS Couteau à plâtre	556	KELLY Pincés à polypes	285
HORGAN Valves centrale	417	KELLY Pincés hémostatiques	222,230
HÖSEL Portes-aiguilles	497	KELLY-RANKIN Pincés hémostatiques	224
HOUSE Canules aspiratrice	531	KELMAN-McPHERSON Pincés à sutures	199
HRYNTSCHAK Ecarteur vésical	465	KERSTING Pincés intestinales	258
Huile pour instruments	608	KEYES Trepan utanés	32
HULKA Pincés utérines	278	KILLIAN Tube pour lavage	535
HULKA-KENWICK Pincés utérines	278	KILNER (Ragnell) Ciseaux fins	120
HUMBY Dermatome	63	KILNER (Ragnell) Ciseaux fins PROMEUR	124
HUNT Pince à tumeurs	179	KILNER Ciseaux fins à dissection	119
HUNTER Pincés à échardes	161	KILNER Crochet à peau	31,315
Hystérectomie, Pincés à-	272-274		

	Page		Page
KILNER Crochets pour les ailes du nez	308	LEYLA Ecarteurs Système autofixant	455-458
KILNER Portes-aiguilles	488	LEYLA tendeur pour spéculums auriculaires	456
KIRKLIN Ecarteurs malleables	324	LICHTENBERG Porte-aiguilles	496
KIRSCH Ecarteurs à joues	373	LICHTWITZ Trocart	541
KIRSCHNER Ecarteurs abdominaux	419,420	LIEBERMANN Blépharostats	390
KIRSTEIN (Heymann) Ciseaux nasaux	118	Ligature, Ciseaux	117,134
KLAPP Ecarteurs à tendineuses	320	Ligature, Ciseaux PROMEDUR	134
KLEINERT-KUTZ Crochets à peau	31,315	Limes à ongles	30
KLIMA-ROSEGGER Aiguille à ponction	545	LISTER Ciseaux à pansements	135
KLINGENBERG-LOTH Ciseaux à dissection	107	LISTER Ciseaux à pansements pour GAUCHERS	135
KLING-EX Extracteur-Lames	50	LISTER Ciseaux à pansements PROMEDUR	135
KLINIK.BERLIN Pincés presse-tubes	292	LISTER-BURCH Spéculum à ophthalmologie	389
KNAPP Ciseaux à Iris	67	LISTER-EXCENTRIC Ciseaux à pansements	135
KNAPP Ecarteur fin	302	LISTER-SINUS Pince à tampons	295
KNAPP Pince à trachome	204	LISTON Couteaux à amputation	59
KNOWLES Ciseaux à pansements	135	LITTAUER Ciseaux à sutures	117
KOCHER Ecarteurs à griffes	334,338,341,342	LITTAUER Pincés à épiler	163
KOCHER Pincés hémostatiques	231,232	LITTAUER Pincés à ongles	28
KOCHER Pincés intestinales	250	LITTLE Ecarteur	337
KOCHER-BABY Pincés intestinales	249	LITTLEWOOD Pincés intestinales	244
KOCHER-DEBAKEY Pincés intestinales	256	LLOYD-DAVIS Ciseaux pour rectum	113
KOCHER-FINO Pincés hémostatiques	231	LLOYD-DAVIS Pince-Clamp pour anastomose	261
KOCHER-WAGNER Ecarteurs	347	LOCKHART-MUMMERY Sondes pour fistules	523
KOENIG Ciseaux à fendre les ongles	33	LOCKKLIN Ciseaux pour genève	106
KOENIG Guides-fils	516	LOCKKLIN Ciseaux pour genève PROMEDUR	134
KOERTE Ecarteurs à griffes	336	LOCKWOOD Pincés intestinales	245
KOERTE Spatules abdominales	356	LONDON-COLLEGE Brucelles	173
KOGAN Endospéculums	466	LORDAN Pince à chalazion	207
KÖNIG Ecarteurs fins	320	LORENZ Ciseaux à pansements	135
KONRICH Boîtes à Stérilisation	607	LORNA Pincés à champs	291
KRAUSE Trocart pour sinus maxillaire	542	Loupes binoculaires	19
KRONECKER Aiguilles à ligatures	515	Loupes frontales	19
KUEHNE Pincés porte-lammelles	162	LOVE Crochets à nerfs	312
KUEMMEL Spatules abdominales	356	LOVELACE Pincés à poumon	241
KÜSTNER Pince utérine	281	LOVELACE Pincés hémostatiques	223
L			
LA GRANGE Ciseaux à sclerectomie	69	LOWER Pincés à canal biliaire	263
LAHEY Crochets à nerfs	311	LUCAE Crochets auriculaires	305
LAHEY Ecarteur pour goitre	337	LUKENS Ecarteurs à trachéotomie	322
LAHEY Pincés à canal biliaire	262	LURZ Pincés à urètere	269
LAHEY-METZENBAUM Ciseaux à dissection	101	M	
LAMBERT Pincés à chalazion	206	Magasin à étiquettes d'identification	602
LAMBOTTE Crochet pour os	368	MAGILL Pincés à intubation	36
Lames de Rasoir	64	MAGILL Tubes à aspiration	536
LANCASTER Blépharostat	389	MAIER Pincés à polypes	296
LANDAU Trocart	542	Maillet à autopsie	587
LANDOLD Manches à bisturies	51	MALTZ Ecarteurs	307
LANE Levier à os	368	Mammoplastie, Ecarteurs- Manches à bisturies	50-56
LANE Pincés à champs	291	Manches à bisturies, Anatomie	50
LANE Pincés à griffes	154	Manches à microbistouris	51
LANE Pincés-Clamps intestinales	254	Manches à piles pour laryngoscopes	38,40
LANE-TRETHOWAN Levier à os	368	Manches à piles pour laryngoscopes à Fibre Optique	44,46
LANGE Crochet pour choana	307	MANNERFELT Ecarteurs fins	316-317
LANGENBECK Couteau à amputation	59	MANNERFELT-LANGENBECK Ecarteurs fins	317
LANGENBECK Couteaux à reséction	60	MARBERGER Ecarteurs malleables	325
LANGENBECK Ecarteurs	339,340	MARINUS Pincés-Clamps pour l'intestin	260
LANGENBECK Portes-aiguilles	493	MARKHAM-MEYERDING Ecarteurs autostatique	406
LANGENBECK-MINI Ecarteurs	323	MARSCHIK Pincés à amygdales	238
Laryngoscopes	37-46	Marteaux à percussion	16
Laryngoscopes, Fibre Optique	43-46	MARTEL Pince pour le cuir chevelu	284
LATERAL Ecarteur vaginal	466	MARTIN Ciseaux pour le cartilage	123
LAWRENCE Pincés hémostatiques	235	MARTIN Compas pelvimètre	25
LAZAR Micro Pince à ligatures	160	MARTIN Ecarteur	348
LEGUEU Ecarteur vesicale	412	MARTIN Pince à déchets	298
LEMPERT Pince à envies	29	MASSON Portes-aiguilles	494,504
LERCHE Pincés à griffes	153	MATHIEU Ecarteurs	321,330
LERICHE Pincés hémostatiques	223	MATHIEU Portes-aiguilles	496,505
LERICHE Spatules abdominales	356	MATHIEU Spéculum	462
LERMOYEZ Trocarts pour sinus maxillaire	542	MATHIEU-KOCHER Portes-aiguilles	496
LESTER Pincés à fixation	196	MATHIEU-SLIM Portes-aiguilles	505
LeVASSEUR-MERRILL Ecarteurs extra-oraux	381	MAYO Ciseaux à dissection	98,125,565
Leviers à os	368,369	MAYO Ciseaux à dissection pour CHIRURGIE BARIATRIQUE	565
LEXER-BABY Ciseaux à dissection	100	MAYO Ciseaux à dissection PROMEDUR	125

	Page		Page
MAYO Ciseaux à dissection SUPERCUT	98	MIDDELDORPF Ecarteurs	342,343
MAYO Ciseaux pour la CHIRURGIE BARIATRIQUE	565	MIKULICZ Ecarteurs	348,349
MAYO Epingles à instruments	299	MIKULICZ Pincés à péritoine	270
MAYO-ADAMS Ecarteur abdominal	412	MIKULICZ-BABY Pince à péritoine	270
MAYO-BLAKE Pincés pour calculés bilaires	265	MILLER Ecarteurs	318
MAYO-GUYON Pincés renaux	266	MILLER Ciseaux pour rectum	112
MAYO-HARRINGTON Ciseaux à dissection	99,126	MILLER Laryngoscopes	39,40,43,45,46
MAYO-HARRINGTON Ciseaux à dissection PROMEDUR	126	MILLER Laryngoscopes à Fibre Optique	45
MAYO-HARRINGTON Ciseaux à dissection SUPERCUT	99	MILLER-BABY Laryngoscope	38
MAYO-HEGAR Portes-aiguilles	490,502,576	MILLESÍ Ciseaux à Microchirurgie	82
MAYO-HEGAR Portes-aiguilles pour CHIRURGIE BARIATRIQUE	490,502,576	MILLIGAN Ecarteur autostatique	398
MAYO-HEGAR Portes-aiguilles PROMEDUR	490	MILLIN Ecarteur à prostatectomie	464
MAYO-LEXER Ciseaux à dissection	99	MILLIN Ecarteur pour col vésical	464
MAYO-LEXER Ciseaux à dissection PROMEDUR	126	MILLS Ciseaux vasculaires boutonés	110
MAYO-LEXER Ciseaux à dissection SUPERCUT	99	MINI-Bulldog Clips	211
MAYO-NOBLE Ciseaux à dissection	99	Mini-Containers à stérilisation	598
MAYO-ROBSON Pincés intestinales	251	MINI-GEMINI Pincés hémostatiques	234
MAYO-RUSSIAN Pince pour vaisseaux	154	MINIMUS Tensiomètre	9
MAYO-STILLE Ciseaux à dissection	98,125	MINI-ROUX Ecarteurs	330
MAYO-STILLE Ciseaux à dissection SUPERCUT	98	Miroirs frontaux	20
MAYO-STILLE Ciseaux à dissection PROMEDUR	125	MISKIMON Ecarteur cérébral	433
McCOLLOUGH Pincés à strabisme	202	MIXTER Ciseaux opératoires fins	95
McGUIRE Ciseaux pour la cornée	67	MIXTER Explorateur à calculés bilaires	527
McINDOE Ciseaux pour cartilage	122	MIXTER Pincés à canal bilaire	263
McINDOE Pince à griffes	143	MIXTER Pincés hémostatiques	236
McINDOE Pince à griffes TITAN	143	MIXTER Pincés pour calculés bilaires	265
McINDOE Pincés à griffes PROMEDUR	165	MIXTER-BABY Pincés hémostatiques	235
McINTOSH Laryngoscopes	37-38,43,44	MIXTER-O'SHAUGHNESSY Pincés hémostatiques	233
McPHERSON Pincés à sutures	199	MOBERG Ecarteurs fins	320
MEEKER Pincés hémostatiques	235	MOCK Aiguille pour heparin	547
MELLINGER Blépharostats	389	MODULAR Système Ecarteurs	439-441
MELLINGER-AXENFELD Blépharostats	389	MOELTGEN Rapporteur	22
MEMORY Spatules cérébrales	460	MOLLISON Ecarteur autostatique	398
MENGHINI Aiguilles à biopsie	545	MOORFIELD Pincés à sutures	200
Menisque, Ecarteurs-	370	MORRIS Ecarteurs	345
MERIAM Brucelles	174	MORRIS Ecarteurs double	331
METZENBAUM Ciseaux à dissection	100-103,128-132	MORRIS-MITRAL Ecarteur vasculaire	409
METZENBAUM Ciseaux à dissection pour CHIRURGIE BARIATRIQUE	564,565	MOSQUITO Pincés hémostatiques	221
METZENBAUM Ciseaux à dissection pour GAUCHERS	101	MOSQUITO Pincés hémostatiques pour GAUCHERS	221
METZENBAUM Ciseaux à dissection PROMEDUR	128-132	MOSQUITO Pincés hémostatiques TITAN	221
METZENBAUM Ciseaux pour la CHIRURGIE BARIATRIQUE	564	MOYNIHAN Explorateur à calculés bilaires	527
METZENBAUM X-FINO Ciseaux à dissection SUPERCUT	131	MOYNIHAN Pincés à canal bilaire	262
METZENBAUM-BABY Ciseaux à dissection	100	MOYNIHAN Pincés à champs	291
METZENBAUM-FINO Ciseaux à dissection	103,130,132	MUELLER Blépharostat	389
METZENBAUM-FINO Ciseaux à dissection PROMEDUR	130,132	MULDOON Stylet Dilateur	521
MEYERDING Ecarteurs autostatique	406	MURDOCK Blépharostat	388
MEYERDING Ecarteurs fins	319,348	MURPHY Ecarteurs	335
MEYERDING Valves pour ecarteurs	438	MUSEUX Pincés utérines	281
MEYER-SCHWICKERATH Localisateur	302		
MICHEL Argafes	507	N	
MICHEL Pincés à poser et enlever agrafes	506	NABATOFF Trousse pour varices	543
MICHEL Trousse à sutures	508	NAGEL Micro Ciseaux	87
Micro Ciseaux	70-90	NAUNTON-MORGAN Porte-aiguilles	495
Micro Ciseaux à Arteriotomie	79	NEGUS Pincés à amygdales	237
Micro Ciseaux à Hypophysectomie	90	NEIVERT Crochets pour les ailes du nez	307
Micro Ciseaux avec manche "Crayon"	89	NELATON Sonde boutonée cannelée	523
Micro Ciseaux coronaires	80,81	NELSON Pincés à griffes	153
Micro Ciseaux pour la Gynecologie	78	NELSON Trocarts	541
Micro Clips	210	NEW ORLEANS Portes-aiguilles	491
Micro Ecarteurs autostatiques	392	NEWS Ecarteurs à tracheotomie	322
Micro Micro Portes-aiguilles avec manche-profil	486	NICOLA Micro Ciseaux	90
Micro Pince à griffes	147	NISSEN Pincés hémostatiques	226
Micro Pincés à dissection	176-188	NORFOLK-NORWICH Ecarteur autostatique	397
Micro Pincés à dissequer	141	NOTO Pince à polypes	286
Micro Pincette mors circulaire, strié	187	NOVA-PRESAMETER Tensiomètre	8
Micro Pincettes à manches "Profil"	186-188	NOYES Ciseaux à iridectomie	70
Micro Pincettes, mors circulaires	187	NUGENT Pincés à strabisme	203
Micro PORTE-AIG 15cm/0,8mm drt.	483	NUSSBAUM Pincés intestinales	252
Micro Portes-aiguilles	470-486		
Micro Vannas Ciseaux	76	O	
MICRO-HARTMANN Pincés hémostatiques	220	O'BRIEN Ciseaux à sutures	117
MICRO-JACOBSON Pincés hémostatiques Pince extra fin 12,5 cm	221	OBWEGESER Ecarteur pour spina nasalis	374
MICRO-MOSQUITO Pincés hémostatiques	221	OBWEGESER Ecarteurs cannelés	377
MICRO-VASCULAR Portes-aiguilles	489,491	OBWEGESER Ecarteurs pour chirurgie maxillo-facial	371,372
MICRO-VASCULAR-SELECT Portes-aiguilles	491		

	Page		Page
OBWEGESER Ecarteurs pour ramus	374,375,376	PINARD Stéthoscopes	18
OBWEGESER Soutien-menton	377	PINCE à griffes pour la CHIRURGIE BARIATRIQUE	566
OCHSNER Pince à sutures	507	Pince à ongles	28
OCHSNER Trocarts	541	Pince à poser Micro Clips	210
O'CONNOR Crochet à iris	302	Pince à saisir la prostate	269
O'CONNOR Pince conjonctivale	193	Pince conjonctivale	193
OCULUS Loupes binoculaires	19	Pince episclerale	197
OEHLER Pincettes à griffes PROMEDUR	166	Pince perce-membrane	285
OLDBERG Crochets à nerfs	314	Pince pour appliquer et retirer clamps arteria/vena	216
OLIVECRONA Spatules cérébrales	460	Pince pour columnelle	190
OLIVECRONA Ciseaux à dure-mère	111	Pince pour le canal déférent	269
OLLIER Ecarteurs	336	PINCE pour mesurer os	23
OLSEN-HEGAR Portes-aiguilles	498,505	Pince pour ouvrir les bouteilles d'infusion	299
OLVECRONA Clamps bronchiques	229	Pince pour vaisseaux	152-127
OLVECRONA Pincettes à dissequer	229	Pince-fixe canal déférent	269
OMBREDANNE Pince intestinale	245	Pincettes à bronches	239,240
ONG Ciseaux à iridectomie	71	Pincettes à calculs renaux	267,268
Ongles, limes à	29	Pincettes à chalazion	205-207
Ongles, Pincettes à-	33	Pincettes à champs	290-291
Ophthalmologie, Crochets, Ecarteurs-	302-304	Pincettes à coagulation bipolaire	167-171
Ophthalmoscope de poche	15	Pincettes à dissection pour Microchirurgie	176-188
Ophthalmoscopes	12-15	Pincettes à dissequer	140-156
ORL DeLuxeTrousse Diagnostique	11	Pincettes à dissequer PROMEDUR	164-166
ORL Trousse Diagnostique	12	Pincettes à dissequer TITAN	140-146,148,149,151,153
Os, Leviers à-	368,369	Pincettes à dissequer USA-MODEL	144
OSCILLOW-E.P. Scies à plâtre électrique	558-560	Pincettes à échardes	160-161,163
O'SULLIVAN-O'CONNOR Ecarteur abdominal p. CHIRURGIE BARI- ATRIQUE	575	Pincettes à envies	28,29
O'SULLIVAN-O'CONNOR Ecarteurs abdominaux	422,575	Pincettes à épilation	163
Oto-Ophthalmoscopes	13-15	Pincettes à éponges	293-297
Otoscopes	13-15	Pincettes à faux germes	284-287
Otoscopes de poche	15	Pincettes à fixer	196-197
OVERHOLT-BABY Pincettes hémostatiques	233	Pincettes à griffes	147-155
OVERHOLT-GEISSENDOERFER Pincettes hémostatiques	233	Pincettes à griffes PROMEDUR	164-166
OVERHOLT-MIXTER Pincettes hémostatiques	233	Pincettes à griffes USA Model	150
		Pincettes à Hypophyse	175,179,184,187,188
		Pincettes à Hystérectomie	272-281
		Pincettes à intestins	154,156
		Pincettes à intubation	36
		Pincettes à iris	140,191-195
		Pincettes à ligatures	160
		Pincettes à microscopie	141,161
		Pincettes à ongles	28,33
		Pincettes à pansements	295
		Pincettes à peritone	270-271
		Pincettes à plâtre	557
		Pincettes à polypes	296
		Pincettes à polypes	295
		Pincettes à poumon	239-242
		Pincettes à prehension	243-248
		Pincettes à pression	261,271
		Pincettes à stérilisation	298
		Pincettes à strabisme	202,203
		Pincettes à sutures	198-199,507
		Pincettes à tampons	295
		Pincettes à tampons avec couvercle et porte-pince	610
		Pincettes à urètre	269
		Pincettes auriculaires	189
		Pincettes capsulaires	200-201
		Pincettes fines à dissequer	144
		Pincettes fines à dissequer TITAN	144
		Pincettes fins à griffes	147-155
		Pincettes fixe-toiles	605
		Pincettes hémostatiques	220-236
		Pincettes musculaires	203,204
		Pincettes nasales	190
		Pincettes péritoine	270,271
		Pincettes porte-laminaires	162
		Pincettes pour abaissement du col utérin	276-281
		Pincettes pour amygdales	237-238
		Pincettes pour calculs biliaires	265-265
		Pincettes pour la conjonctiva	193
		Pincettes pour le canal choledoque	262-263
		Pincettes pour le cuir chevelu	284
		Pincettes pour le trachome	204
		Pincettes pour Micro Chirurgie	176-188

P

Panier avec couvercle	599
PANIER avec couvercle pour Dental Containers	601
Paniers grillagés	593,595,597,599,600,601
Paniers pour Endoscopie	600
Pansement et Plâtre	555-560
Pansements, Ciseaux	135-137
Parametrium Ciseaux PROMEDUR	127
PARK Blépharostat	389
PARKER Bistouris	58
PARKER Ecarteurs	328
PARKER-LANGENBECK Ecarteurs	329
PARKER-MOTT Ecarteurs	329
PARK-GUYTON Blépharostat	389
PARK-MAUMENEE Blépharostat	389
PAUFIQUE Pince à sutures	198
PAUFIQUE Pincettes à sutures TITAN	198
PAYR Guide-fils	516
PAYR Sondes cannelées	516
PEAN Pincettes hémostatiques	227
PEAN-FINO Pincettes hémostatiques	228
PECK-JOSEPH Ciseaux fins à dissection	105
PEERS Pincettes à champs	290
PEET Pince à échardes	162
PELKMANN Pincettes à pansements	295
Pelvimètres	25
PENNINGTON Pincettes intestinales	243
Perforateur à ongles	33
Perforateurs à ongles	33
Periostotome à rugine	60
PERKINS Ecarteurs autostatique	399
PERWITZSCHKY Ciseaux pour voie salivaire	123
PETRI Boîte ronde	609
PHANEUF Pincettes péritoine	271
Phlébite, Dissecteurs	544
Pieds à coulisse	24
PIERCE Trocarts pour sinus maxillaire	542
PIFFARD Curettes pour les lupus	32

	Page		Page
Pincés pour Neuro Chirurgie	175	RAMSAY Pincés à griffes	152
Pincés pour polypes utérines	285,286	RANDALL Pincés à calculs rénaux	267
Pincés pour saisir tumeurs et tissus	179,184,184,187-188	RANKIN-CRILE Pincés hémostatiques	224
Pincés pour urètre	268	RANKIN-KELLY Pincés hémostatiques	224
Pincés presse-tube	292	Raquiotope	587
Pincés presse-tube avec protecteur	292	Raspatoires pour CHIRURGIE BARIATRIQUE	425
Pincés tire-langue	36	RAYONS-X Ecarteur abdominal	61
Pincés vasculaires	145,157-159,165-166	Razoír	611
Pincés vasculaires TITAN	158,185	Récipients cylindriques	548
Pincés, Micro- à sutures	178,180,182,183,	RECORD Seringues	540
Pincés-Clamps intestinales	249-261	REDON Aiguilles-Guidage	22
Pincés-Clamps renales	266	Règles	474
Pincés-Dissecteurs	239-242	REILL Micro Portes-aiguilles	556
Pincés-Dissecteurs à ligatures	239	REINER Couteaux à plâtre	304
Pincés-gouge pour CHIRURGIE BARIATRIQUE	580	Releveurs de paupières	123
Pincés-Hystérolabes	282-283	RESANO Ciseaux pour le cartilage	258
PINCES-SELECT à microscopie	141	RESANO Pincés intestinales	605
Plaquettes d'identification	602	Ressort spiraux pour instruments	513
Plateaux à instruments	612	REVERDIN Aiguilles à ligatures	355
PLESTER Ecarteurs autostatique	393	REVERDIN Spatules abdominales	104
PLESTER Canules aspiratrice	534	REYNOLDS Ciseaux fins à dissection	306-308
PLEY Blépharostat	389	Rhinologie, Crochets pour-	11-12
POCKET-MINI Trousse à Sutures	509	Rhinoscopes	15
POCKET-VENAE-SECTIO Trousse	512	Rhinoscopes de poche	180-184
POLLOSON Ecarteurs pulmonaires	365,366	RHOTON Micro Pincés	180,181,184
POOLE Canules à aspiration	538,578	RHOTON Micro Pincés avec contre-poids	180-184
POOLE Tubes à aspiration pour CHIRURGIE BARIATRIQUE	578	RHOTON Micro Pincés TITAN	180-185
Portes-Aiguilles	469-504	RHOTON Pincés pour Microchirurgie	180-184
Portes-Aiguilles avec bouts de diamant	482,483-485,489,491,500	RHOTON Pincés pour Microchirurgie TITAN	66
Portes-Aiguilles avec ciseaux	497,498,505	RIBBON Cisaux à Strabisme	66
Portes-Aiguilles en TITAN	483-485,489	RIBBON Ciseaux à sutures	355
Portes-Aiguilles Micro	470-486	RIBBON Spatules abdominales	66
Portes-Aiguilles pour GAUCHERS	488,489,490,497,498,505	RIBBON-IRIS Ciseaux	66
Portes-Aiguilles PROMEDUR	470,471,479,-481	RIBBON-KAYE Ciseaux à blépharoplastie	66
Portes-coton	529	RIBBON-STEVENS Cisaux fins	413
Portes-coton pour rectoscopes	529	RICARD Ecarteurs abdominaux	343
Portes-Lames	64	RICHARDSON Ecarteurs	343
POST MORTEM Aiguilles à suture	588	RICHARDSON-EASTMAN Ecarteurs	507
Post-Mortem Lames de bisturis	50	RICHTER-HEATH Pince à enlever agrafes	410
POTTS Ciseaux à dissection	94	RIGBY Ecarteurs autostatique	524
POTTS-DE-MARTEL Ciseaux vasculaires	110	RITTER-HALLE Dilatateurs	228
POTTS-SMITH Ciseaux vasculaires	108	ROBERTS Pincés hémostatiques	414
POTTS-SMITH Ciseaux vasculaires PROMEDUR	133	ROBIN-MASSÉ Ecarteur abdominal	570
POTTS-SMITH Pincés à dissequer	145,146	ROCH.-OCHSNER Pincés hémostatiques pour CHIRURGIE BARI-	423
POTTS-SMITH Pincés à dissequer TITAN	145,146	TRIQUE	423
POTTS-SMITH Pincés à griffes	152	ROCHARD Compas	423
POTTS-SMITH Pincés à griffes PROMEDUR	164	ROCHARD Dispositifs	423
POTTS-YASARGIL Micro Ciseaux	88	ROCHARD Ecarteurs abdominaux	227
Poubelles pour coton	608	ROCHESTER-CARMALT Pincés hémostatiques	232
POZZI Pince utérine	277	ROCHESTER-OCHSNER Pincés hémostatiques	270
PRATT Crochets à crypte	526	ROCHESTER-OCHSNER Pincés hémostatiques/CHIRURGIE BARI-	568
PRATT Pince utérine	280	ATRIQUE	228,568
PRATT Sondes à fistules	526	ROCHESTER-PEAN Pincés hémostatiques p. Chirurgie Baratrique	291
PRATT-"T" Pince à préhension	248	ROCHER Pincés à champs	298
PRECISA I Tensiomètre	8	ROGGE Pincés à stérilisation	302
Préparation	28-34	ROLLET Ecarteur fin	322
PRESBYTERIAN Pincés presse-tube	292	ROSE Ecarteurs à trachéotomie	534
PRICE-THOMAS Pincés à bronches	240	ROSEN Canules aspiratrice	384
PRINCE Cisaux pour les amygdales	122	ROSS Ecarteurs pour l'aorta	330
PRINCE Pincés musculaires	205	ROUX Ecarteurs	330
PRO-MED Ecarteur pour laminectomie	442	ROUX-BABY Ecarteurs	330
PRO-MED Porte-aiguilles, Mod. Suedoise	499	ROUX-MINI Ecarteurs	31
PROVIDENCE-HOSPITAL Pincés hémostatiques	222	Rugine pour les lupus	234
		RUMEL Pincés hémostatiques	566
Q		RUSSIAN Pince à griffes pour CHIRURGIE BARIATRIQUE	154
QUINBY Ciseaux pour gencive	121	RUSSIAN Pincés pour vaisseaux	499
QUINCKE Aiguilles lombaires	545	RYDER Portes-aiguilles	499
		RYDER-MINI Portes-aiguilles	500
		RYDER-MINI-SELECT Portes-aiguilles	31
R			310
RADOLF Pince à ongles	33	S	287
RAGNELL Ecarteurs	321	SAALFELD Tire-Comedone	310
RAMEL Aiguille à biopsie-plevre	546	SACHS Crochet pour dure-mère	287
RAMPLEY Pincés à éponges	294	SAENGER Pincés à faux germe	
RAMSAY Pincés à dissequer	145		

	Page		Page
SAMII Micro Pincette mors circulaire	188	SIMS-MAIER Pincettes à polypes	295
SANTULLI Clamp Bulldog	214	SINGLEY (TUTTLE) Pincettes pour vaisseaux	154
SANVENERO Ciseaux pour la chirurgie plastique	121	SKENE Pince utérine	279
SAROT Pincettes à bronches	239	SMILLIE Ecarteurs pour ménisque	370
SAROT Pincettes hémostatiques	230,569	SMITH (US-ARMY) Ciseaux à pansements	136
SAROT Pincettes hémostatiques pour CHIRURGIE BARIATRIQUE	569	SMITH Blépharostat	388
SAROT Portes-aiguilles	495	SMITH Ciseaux à fils PROMEDUR	134
SATINSKY Ciseaux pour la veine cave	107	SMITH-BUIE Ecarteur rectal	463
SATINSKY Pincettes vasculaires	242	SMITHWICK Crochets à nerfs	310
SAUER Blépharostat	388	SOFIELD Ecarteurs	331
SAUERBRUCH Boîte à aiguilles	609	SOMER Pince Hystérolabe	282
SAUERBRUCH Ecarteurs	349,350	Sondes	528
SAUERBRUCH Pince à déchets	298	Sondes à fistules	526
SAWTELL Pincettes à amygdales	237	Sondes auriculaires	524
SCALP-CONTOUR Ecarteurs autostatiques	393	Sondes boutonées cannelées	523
Scellés de sécurité plastique	602	Sondes cannelées	523
SCHAEDEL Pincettes à champs	290	Sondes cannelées	523
SCHAMBERG Tire-Comédon	31	Sondes feuille myrte	523
SCHIMMELBUSCH Boîtes à stérilisation	607	Sondes nasales	524
SCHINK Dermatome	62	Sondes vasculaires	525
SCHMID Canules pour lavage	536	Spatules abdominales	355-359
SCHMIEDEN-TAYLOR Ciseaux à dure-mère	111	Spatules cérébrales	459,460
SCHNIDT Pincettes à amygdales	237	Spatules pulmonaires	361,363-366
SCHOEMAKER Ciseaux pour goitre	123	Spéculum abdominal	424
SCHOEMAKER-LOTH Ciseaux à sutures	117	SPENCER Ciseaux à sutures	117
SCHROEDER Pincettes utérines	277,279	SPENCER-WELLS Pincettes hémostatiques	227
SCHUKNECHT Ecarteur autostatique	399	St.MARKS Ecarteur à perinée	463
SCHUMACHER Ciseaux pour le cordon ombilical	116	St.MARKS Ecarteur pelvien	360
SCHWARTZ Clips Bulldog	211	St.MARTIN Pince à sutures	198
SCHWARTZ Pince à appliquer Clips Bulldog	211	STACKE Sonde auriculaire	524
SCHWEIGGER Pincettes à sutures	200	STAUDE-MOORE Pince utérine	276
Scies à main à plâtre	556	STEINHÄUSER Ecarteurs zygygomatiques	373
Scies électrique à plâtre	558-560	STELZNER Ciseaux pour rectum	113
Scies pour bagues	34	Stérilisation	592-607
SCOVILLE Crochets à nerfs	313	Stérilisation, pincettes à-	298
SCOVILLE Ecarteurs pour Hemilaminectomie	436	Stéthoscopes	18
SCOVILLE Ecarteurs pour laminectomie	436	STEVENS Ciseaux à tenotomie	93
SCOVILLE Ecarteurs pour racines nerveuses	312	STEVENS Crochet à tenotomie	304
SCOVILLE Pincettes-Spatule	175	STEVENS Pincettes à Iris	191
SCOVILLE-HAVERFIELD Ecarteur pour laminectomie	437	STEVENS Portes-aiguilles	472
SCOVILLE-RICHTER Ecarteur pour laminectomie	435	STEVENSON Blépharostat	389
SCUDDER Pincettes intestinales	251	STIEGLITZ Pincettes à échardes	162
SCUDDER-DEBAKEY Pincettes intestinales	259	STILLE Cisailles à platre	137
SCULPO Ecarteurs à Mammoplastie	367	STILLE Pincettes à dissequer	144
SEGOND-LANDAU Pincettes à Hystérectomie	272	STILLE Pincettes renaux	266
SEMB Pincettes à bronches	241	STILLE-BARRAYA Pincettes pour vaisseaux	155
SEMKEN Pincettes à dissequer	143	STILLE-HAGLUND Ecarteur à plâtre	557
SEMKEN Pincettes à dissequer TITAN	143	STONE Pince à griffes	153
SEMKEN Pincettes à griffes	149	Strabisme, Ciseaux-	92
SEMKEN Pincettes à griffes PROMEDUR	164	Strabisme, Ciseaux- SUPERCUT	92
SEMM Ecarteur abdominal	421	STRANDELL-STILLE Ecarteurs fins	320
SENN-GREEN Ecarteurs	323	STRATTE Portes-aiguilles	495,504
SENN-MILLER Ecarteurs	321	STRINGER Etriers pour instruments	299
SENN-MILLER-BABY Ecarteurs	321	STRULLY Ciseaux pour la Neuro-Chirurgie	111
Séparateurs pour Containers	593,595,597,606	Stylets double	522
Seringues	548-550	Stylets double pour CHIRURGIE BARIATRIQUE	522,577
Seringues à 3 anneaux	549	Stylets pour le canal lacrymal	520
Seringues à eau, auto-replisante	551-552	Stylets-aiguille	522
Seringues à irrigation	551,552	SUPERLEGER Clamps Bulldog	215
Seringues auriculaires	551	SYSTRUNK Cisaux à fendre les ongles	33
SEUTIN Ciseaux à plâtre	138		
SEXTON Ecarteur autostatique	401	T	
SHAAF Pince à corps étrangers	163	Tapis porte-instruments, Silicone	604
SHEA Ciseaux à transplantation	120	TAYLOR Ecarteurs spinaux	309
SHEA Ecarteur pour usage universelle	381	TAYLOR Marteau à percussion	16
SIEBENMANN Tubes à aspiration	536	TAYLOR Pincettes à dissequer	146
SIEBOLD Ciseaux utérins	115	TAYLOR Pincettes à dissequer TITAN	146
Silicone bande à sécuritée	605	TAYLOR Pincettes à griffes	152
Silicone Tapis porte-instruments	605	TAYLOR Valves	438
SILVER Dermatome	63	TAYLOR-CUSHING Pincettes à dissequer	146
SIMON bistouris	58	TAYLOR-CUSHING Pincettes à griffes	152
SIMON Crochets pour fistules	327	TEALE Pincettes utérine	281
SIMS Ciseaux pour Gynécologie	114	TEMPLE-FAY Ecarteur pour laminectomie	436
SIMS Ciseaux pour Gynécologie PROMEDUR	126	Tendeur pour spéculum auriculaires	456
SIMS Ciseaux pour Gynécologie SUPERCUT	114		

	Page		Page
Tenotomie, Ciseaux-	93	VIDAL Rugine pour les lupus	31
Tensiomètre	8	VIRCHOW Couteaux à cartilage	60
Tensiomètres	8-10	VIRCHOW Couteaux cérébraux	60
TERSON Pince capsulaire	201	VIRTUS (RALK) Pince à échardes	162
THOMS-ALLIS Pincés intestinales	244	Vis à distraction	453
THOMSON-WALKER Ecarteur vesical	465	WISE Micro Pincés à ligatures	160
THOREK (HALLE) Ciseaux à dissection	100	Vitrectomie Ciseaux	75
THOREK Ciseaux pour le poumon	100	VOLKMANN Crochets pour os	335
THORPE (Marchac) Pied à coulisse	24	VOLKMANN Ecarteurs à griffes	332,333,335
TIEMANN Pince tire-balle	279	VOLLMAR Tires-veines	543
Tige à nettoyage pour FRAZIER/FERGUSON	533		
Tige à nettoyage pour MAGILL	536	W	
Tires-Comédon	31	WACHENFELDT Pince à affronter	506
TOENNIS Ciseaux à dissection	104	WACHENFELDT Pince à poser agrafes	506
TOENNIS Crochets à dure-mère	311	WAGENER Crochets auriculaires	305
TOENNIS Pincés hémostatiques	231	WAGNER Ciseaux fins à dissection	105
TOENNIS Portes-aiguilles	492	WAGNER Ciseaux fins à dissection SUPERCUT	105
TOENNIS-ADSON Ciseaux à dissection	104	WALDMANN Ciseaux à episiotomie	116
TOENNIS-ADSON Ciseaux PROMEDUR	128	WALKER Ciseaux à Iridectomie	92
TOENNIS-RYDER Portes-aiguilles	492	WALTON Ecarteurs autostatique	398
TOHOKU Pincés à champs	291	WALTON Cisaille à platre	138
Transformateur 220 V, 1 A	20	WALTON Ecarteur à plâtre	557
TRAVERS Ecarteurs autostatique	397	WALTON Pincés à tampons	295
Trepans Cutane	32	WALTON Scies pour bagues	34
Trepans utanés	32	WANGENSTEEN Pincés à vaisseaux	154
TREVES Pincés à griffes	153	WANGENSTEEN Pincés à vaisseaux PROMEDUR	164
Trocarts	541-542	WANGENSTEEN Portes-aiguilles	494,504
Trocarts pour sinus maxillaire	542	WARTENBERG Algesimètre	17
TROELTSCH Pincés auriculaires	189	WASSMUND Ecarteur	336
TROELTSCH Pincés nasales	190	WATSON Dermatome	63
TROEMNER Marteau à percussion	16	WAUGH Pincés à dissequer	146
Trousse portative pour OSCILLOW Scies à plâtre	560	WAUGH Pincés à griffes	155
Trousses à ORL	11-15	WEBER Aesthesiometre	22
Trousses à Poche	509-512	WEBSTER Portes-aiguilles	488,501
Trousses à Sutures	509,511	WEISS Blépharostat	388
TROUTMAN Ciseaux pour la cornée	73	WEITLANER Ecarteurs autostatique	393,394
TROUTMAN Pincés à Iris	194	WEITLANER-BABY Ecarteur autostatique	393
TROUTMAN Porte-Lames	64	WEITLANER-BECKMANN Ecarteurs autostatique	402
TROUTMAN-RECTUS Pince musculaire	202	WERTHEIM Ciseaux utérins	100
TUBE aspiratrice nasale	535	WERTHEIM Pince à Hystérectomie	270
TUEBINGEN Ecarteur	347	WERTHEIM Pincés à Hystérectomie	272
TUEBINGEN Ecarteur autostatique	410	WERTHEIM Pincés à Hystérectomie	274
TUEBINGEN Micro Crochets à iris	303	WERTHEIM-ATRAUMA Pincés à Hystérectomie	273
TUEBINGEN Pincés à sutures	198	WERTHEIM-CULLEN Pincés à Hystérectomie	273
TUFFIER Pince Intestinale	243	WERTHEIM-DEBAKEY Pincés à Hystérectomie	275
TUFFIER Spatules abdominales	355	WESTCOTT Ciseaux à ténotomie	71
TURNBULL Pince à ongles	28	WESTERMAN (Jensen) Aiguilles à biopsie	546
TURNER-WARWICK Ecarteur abdominal	426-429	WHITE Pincés à amygdales	237
		WICKHAM Clamps Bulldog	215
		WICKHAM Pince à poser/oter Clamps Bulldog	215
		WIEN Porte-ligatures	517
		WIENER Crochets à iris	302
		WIGMORE Scie à main à plâtre	556
U		WIJNEN Aspirateurs	538,578
UCKERMANN Porte-coton	529	WIJNEN Aspirateurs pour CHIRURGIE BARIATRIQUE	578
ULRICH Pincés porte-éponges	296	WIKSTROEM Pincés hémostatiques	235
UNIVERSAL Ciseaux	136	WILDE Pincés auriculaires	189
UNIVERSAL Ciseaux à fils	117	WILDER Stylets Dilatateur	521
UNIVERSAL Ciseaux à fils PROMEDUR	134	WILLET Pince pour le cuir chevelu	284
UNIVERSAL Trocarts	541	WILLIAMS Blépharostats	389
UNIVERSAL Trocarts avec robinet	541	WILLIAMS Pincés intestinales	245
UNNA Tires-Comédon	31	WILMER Ciseaux oculaires	68
UNNA-VIDAL (GREG) Tire-Comédons	31	WINTER Pincés à faux germe	287
URO Pincés pour urètre	268	WISCONSIN-FOREGGER Laryngoscopes	41
USA-Modele Ciseaux pour le cordon ombilical	116	WOLFF Pincés à plâtre	557
US-ARMY Ecarteurs	329	WORST Sonde trabeculaire	521
		WULLSTEIN Canule aspiratrice	534
		WULLSTEIN Ecarteurs autostatique	398
		WULLSTEIN Micro Canule aspiratrice	532
V		Y	
VAN ALEYA Canule pour lavage	542	YANKAUER Tubes à aspiration	537,577
VANNAS Ciseaux à Microchirurgie	76,88	YANKAUER Tubes à aspiration pour CHIRURGIE BARIATRIQUE	537
VANNAS Ciseaux pour la cataracte secondaire	74	YASARGIL Canules aspiratrice	532
VANNAS-MICRO Ciseaux	88		
VANNAS-TÜBINGEN Ciseaux pour la cataracte secondaire	74		
VARADY Dissecteurs pour phlébite	544		
Varices, instruments	543-544		
VAUGHAN Couteau à abscess de poche	61		
VENAE-SECTIO Trousse à poche	512		
VERRES Canules à biopsie	547		

YASARGIL Ciseaux	88
YASARGIL Micro Ciseaux	88
YASARGIL Pince à tumeurs	179
YOUNG Pince à prostatectomie	269
YOUNG Pince tire-langue	36

Z

ZENKER Ecarteurs	353
ZENKER Pinces hémostatiques	230
ZIEGLER Blépharostat	389
ZIEGLER Mirroir frontal	20
ZOELLNER Micro Canules aspiratrice	534

Indice alfabético

A

AACHEN Espátulas cerebrales	459
ABRAMS Aguja para biopsia-pleura	546
ADAIR Pinza para cuello uterino	277
ADAMS Bisturios	58
ADLERKREUTZ Pinzas con dientes	153
ADSON Ganchos para nervios	309
ADSON Pinza para neurocirugía	175
ADSON Pinzas de disección	142,148,149
ADSON Pinzas de disección PROMEDUR	164
ADSON Pinzas de disección TITANIO	142,148
ADSON Pinzas hemostáticas	225
ADSON Pinzas para hipófisis	175
ADSON Separadores autostáticos	393,404
ADSON Tubos de aspiración	531
ADSON-BABY Pinzas hemostáticas	225
ADSON-BABY Separadores	400
ADSON-BROWN Pinza con dientes TITANIO	153
ADSON-BROWN Pinzas con dientes	153
ADSON-BROWN Pinzas de disección PROMEDUR	166
ADSON-DEBAKEY Pinzas de disección	142
ADSON-GRAEFE Pinza de disección	149
ADSON-MICRO Pinzas de disección	142,148
AEBLI Tijeras para cornea	67
AEBLI Tijeras para queratoma	74
Agrafes (Grapas)	507
AGRICOLA Separador para saco lacrimal	390
Agujas de guía para drenaje	540
Agujas para amígdalas	549
Agujas para autopsia	588
Agujas para el tabique nasal	549
Agujas para suturas y ligaduras	513-515
ALABAMA Pinza para estrabismo	203
ALAN-PARKS Espéculo rectal	462
Algesímetros	17
ALLEN Pinzas-Clamps intestinales	243
ALLIS Pinza intestinal para CIRUGIA BARIATRICA	572
ALLIS Pinzas intestinales atraumáticas	244
ALLIS Pinzas intestinales y para tejidos	243
ALLIS-ADAIR Pinzas intestinales y para tejidos	244
ALLIS-BABY Pinzas intestinales y para tejidos	243
ALLISON Espátulas para el pulmón	363
ALLPORT Ganchito auricular	305
ALLPORT Separador	392
ALM Separadores autostáticos	391,392
ALY Algesímetro	17
Amputación, Cuchillos-	59,60
ANDERSON-ADSON Separadores autostáticos	395
Anestesia	35-46
ANVIL Pinza arrance-uñas	33
Apoyos con resorte spiral	605
ARKANSAS piedra afiladora	61
ARRUGA Blefarostatos	388
ARRUGA Pinzas capsulares	201
ARRUGA Portas-agujas	471
ARTERIOTOMIA, Tijeras	79,108
ARTHUR Pinzas para espinas	162
AUFRANC-COBRA Separadores para huesos	369
AUFRICHT Gancho paralas coanas	307
AUFRICHT Separador nasal	307
AUFRICHT Tijeras para cirugía plastica	119
AUSTIN Pinzas para ligaduras	160
AUTOFILL Jeringa para irrigación	551
AXENFELD Ganchos para piel	303
AYER Pinzas de chalazión	206

B

BABCOCK Pinzas intestinales PROMEDUR	246
BABCOCK Pinzas intestinales y para tejidos	245,246
BABCOCK-DEBAKEY Pinzas intestinales	246
BABINSKY Martillo de percusión	16

BABY-ADSON Pinzas hemostáticas	225
BABY-ADSON Separadores	400
BABY-ALLIS Pinzas intestinales y para tejidos	243
BABY-BALFOUR Separador abdominal	415
BABY-COLLIN Separador abdominal	411
BABY-CRILE Pinzas hemostáticas	222
BABY-GELPI Separador	408
BABY-INGE Separadores para cuerpos vertebrales	443
BABY-KOCHER Pinzas intestinales	249
BABY-LEXER Tijeras de disección	100
BABY-METZENBAUM Tijeras de disección	100
BABY-MIKULICZ Pinzas-Clamps para histerectomia	270
BABY-MIXTER Pinzas de disección y ligaduras	235
BABY-ROUX Separador	330
BABY-SENN-MILLER Separadores	321
BABY-WEITLANER Separador	393
BACKHAUS Pinzas para campo	290
BADGLEY Separador para laminectomía	434
BAINBRIDGE Pinzas hemostáticas	227
BAKES Dilatadores para el conducto biliar	528
BALFOUR Brazos laterales	417
BALFOUR Separadores abdominales	415-417
BALFOUR-BABY Separador abdominal	415
BALL e SOCKET Pinzas para campo	291
BALLENGER Pinza para amígdalas	238
BALLENGER Pinzas porta-esponjas	293
Bandejas para instrumentos	612
Bandejita para tabletas	611
BANDIT-LEKSELL Pinzas-gubias para CIRUGIA BARIATRICA	580
BARON Cánulas de aspiración	535
BARR Espéculo rectal	463
BARRAQUER Blefarostatos	388
BARRAQUER Pinza para suturas	199
BARRAQUER Pinzas para la cámara anterior	202
BARRAQUER Pinzas para suturas	194
BARRAQUER Pinzas-fijación	163,196
BARRAQUER Porta-hojas	64
BARRAQUER Portas-agujas	472,473
BARRAQUER Tijeras para iridectomia	71
BARRAQUER-COLIBRI Pinza-fijación	194
BARRAQUER-KATZIN Pinza para transplantación	194
BARRAQUER-TROUTMAN Portas-agujas	472
BARRET Pinza para cuello uterino	276
BARRON Mango de bisturios	54
BARSKY Ganchito para piel doble	307
Base para MINI-cajas	599
BAUER Separadores con luz fria	378
BAUER Separadores intra oral	378
BAUMGARTNER Portas-agujas	488,501
BECKMAN Separador	403
BECKMAN-EATON Separador	403
BECKMANN-ADSON Separadores	404
BECKMANN-WEITLANER Separadores	402
BEEBEE Tijeras para hilos	117
BEER Pinza depilatoria	163
BEESON Pinza para romer yeso	557
BENGOLEA Pinzas hemostáticas	226
BERENS Clamp muscular	205
BERGH Pinza depilatoria	163
BERGMANN Ganchito para fistulas	315
BERGMANN Sierra para yeso	556
BERGMANN Tijera para vendajes	136
BERGMANN-FOERSTER Pinzas porta-esponjas	293
BERKE Pinzas musculares	205
BERLINER Martillos de percusión	16
BERNHARD Pinza para campo	291
BERRY STERNAL Portas-agujas	492
BERTILLON Cefalómetro	23
BEST Pinzas intestinales	253
BIEMER Tijeras para venas	83,88
BIPOL-Cables de conexión	172
BIRKETT Pinzas para amígdalas	238
BISHOP-HARMAN Pinzas para iris	192
Bisturi para abscessos	61
Bisturios	57-58

	Pàgina		Pàgina
BLAKE Pinzas para cálculos biliares	264	Cánulas venosas	547
BLANK Pinzas de disección atraumaticas	144	CAPLAN Tijera para nariz	122
BLASCOVIVS Pinzas musculares	205	CARMALT Pinzas para espinas	161
Blefarostato para niños	388	CARREL Pinza hemostática fina	220
Blefarostatos	388-390	CARROL Goniómetro para dedos	22
BLESSING Tijera para la cirugía del recto	127	CASPAR Espéculo para la hipofisectomía	450
BLOHMKE Pinza para amígdalas	238	CASPAR Espéculos para la cirugía lumbar vertebral	449,450
BLOUNT Elevador para cadera	370	CASPAR Pinza cambiar las valvas	448
BOETTCHER Tijeras para amígdalas	122	CASPAR Separador	340
BONACCOLTO Pinza para suturas	200	CASPAR Separador para la cirugía lumbar vertebral	446
BONACCOLTO Pinzas para estrabismo	203	CASPAR Separadores para cuerpos vertebrales	445
BONN Gancho para iris	303	CASPAR Separadores para la columna cervical	447
BONN Pinza para suturas	198	CASPAR Separadores para la microdissectomia lombar	451-453
BONN Pinzas para iris	193	CASPAR Separadores-opuesto	449,450
BONN Tijeras oculares	67	CASPAR Valvas para separadores	448
BONN Tijeras para estrabismo	67	CASTROVIEJO Blefarostato	389
BONNEY Pinzas con dientes	153	CASTROVIEJO Compases	23
BONNEY Pinzas de disección	145,153	CASTROVIEJO Dilatadore para canal lacrimonal	521
BONNEY Pinzas de disección PROMEDUR	165,166	CASTROVIEJO Pinza capsular	201
BOROWSKI Separadores para atrio	382	CASTROVIEJO Pinzas para suturas	198
BOSE Separador para traqueotomía	391	CASTROVIEJO Pinzas-fijación	197
BOWMAN Blefarostato	388	CASTROVIEJO Porta-hojas	64
BOWMAN Estiletes para el canal lacrimonal	520	CASTROVIEJO Portas-agujas	470
BOWMAN Tijera botonada	107	CASTROVIEJO Tijeas para cornea	72
BOYNTON Porta-agujas	470	CASTROVIEJO Tijeras para iridectomía	72,74
BOYS-ALLIS Pinza intestinal	244	CASTROVIEJO Tijeras para sinequia anterior	72
BOZEMANN Pinzas para tampones y torundas	297	CASTROVIEJO-MICRO Portas-agujas	473
BOZEMANN Portas-agujas	493,503	CATLIN Cuchillos para amputación	59
BOZEMANN Tijera para ginecología	115	Cefalómetro	23
BRAUN Pinza para cuello uterino	276	Cepillos para manos	30
BRAUN-STADLER Tijera para episiotomía	115	Cepillos, distribuidores-	30
BRIDGE Pinzas hemostáticas	227	Cestillo con cobertera	599
BROM Ganchos para venas 19 cm grande	315	Cestillos de esterilización	593,595,597,599-601
BROMPTON Pinza para drenaje	292	Cestillos para Endoscopia	600
BROPHY Pinzas de disección	144,151	CHAPUT Pinza intestinal y para tejidos	243
BROPHY Tijeras finas de disección	121	CHARNLEY Separador	429
BROWN Pinzas con dientes	154	CHARNLEY Separador horizontal	401
BRUNETTI Cincels	587	CHEATLE Pinza para esterilización	298
BRUNNER Agujas para ligaduras	515	CHERON Pinza para tampones y torundas	297
BRUNNER Pinza intestinales	253	CHILDE Pinzas aproximadoras con porta-clips	506
BRUNNER Separadores	351-352	Cinceles rompe-craneo	587
BRUNNER Sondas conductoras	517	Cintas métricas	22
BRUNNER-FERROZELL Sondas conductoras	517	Clamps Bulldog	210-219
BRUNS Cizallas para encayolas	138	CLAR Lamparas frontales	20
BRYANT Pinza para tampones y torundas	295	CLARKE Blefarostato	388
BÜCHS Separador para mejillas	375	CLOWARD Gancho para dura-madre	311
BUCK Martillo de percusión	16	CLOWARD Separadores espinales	309
BUCK Tijera para ligaduras	117	CLOWARD Separadores para cuerpos vertebrales	443
BUIE Pinza-clamp de presión	261	CLOWARD Separadores para la columna cervical	430,431
BUIE Sonda para fistulas	526	CLOWARD-CONTOUR Separadores	400
Bulldog Clips	210,212-219	CLOWARD-HOEN Separador para la columna cervical	432
Bulldog Clips atraumáticas	212-219	Coagulación, Pinzas bipolares-	167-171
Bulldog Clips para arteria / vena	216	COAKLEY Trócar par el seno maxillar	542
Bulldog Clips TITANIO	216	COBBETT Dermatomo	63
BUMM Pinza para pólipos uterinos	286	Cofrecillos de esterilización para instrumentos finos	607
BUNT Porta-instrumentos	299	COHAN Portas-agujas	472
BUSCH Tijera umbilical	116	COHAN-VANNAS Tijeras oculares	74
		COHEN Pinza cuticular	29
		COLLER-CRILE Pinza para CIRUGIA BARIATRICA	567
		COLLER-CRILE Pinzas hemostáticas	224
		COLLIER Portas-agujas	501
		COLLIN Dinamómetro	22
		COLLIN Mangos de bisturios	53,55
		COLLIN Pelvimetro	25
		COLLIN Pinza para polipos	297
		COLLIN Pinza para quitar agrafes	507
		COLLIN Pinza tira-lengua	36
		COLLIN Pinzas intestinales y para tejidos	247
		COLLIN Pinzas para el útero	282
		COLLIN Separadores	329
		COLLIN Separadores abdominales	411
		COLLIN-BABY Separador abdominal	411
		COLLIN-DUVAL Pinzas intestinales	156
		COLLIN-HARTMANN Separador	330
		COLLIN-LOCKTITE Separador abdominal	412
C			
Cables de conexión para pinzas bipolares	172		
Cajas de esterilización	593-603,607,612		
Cajas para instrumentos	612		
Cajedin clasificador de identificación	602		
CALIBRADOR para neuro-cirugía	24		
Calibradores	24		
CANNY-RYALL Separadores	329		
Cánula laríngea	549		
Cánulas de aspiración conical	535		
Cánulas de aspiración nasal	535		
Cánulas para aspiración	530-534		
Cánulas para biopsia	546		
Cánulas para insuflación	547		
Cánulas para irrigación	536		
Cánulas para punción	545		

	Página		Pàgina
COLLYER Pelvimetro	25	DAVIS Espátulas cerebrales	459
COLVER Pinzas para amígdalas	238	DAVIS Pinzas para esterilización	298
Compases	23	DAY Ganchitos auriculares	305
CONE Separadores autostáticos p. hemilaminetomia	397	DEAN Tijeras para amígdalas	122,134
Contenedores par Endoscopia	600	DEAVER Separadores abdominales	357-359,574
CONVERSE Separador nasal	308	DEAVER Separadores para CIRUGIA BARIATRICA	574
CONVERSE-ALAR Separador	308	DEAVER Tijeras finas para cirugía	94
COOK Blesfarostatos	390	DEBAKEY Clamps Bulldog	217,218
COOLEY Pinzas vasculares	158	DEBAKEY Clamps Bulldog con anillos	218
COOLEY Pinzas vasculares TITANIO	158	DEBAKEY Dilatadores vasculares	525
COOLEY Tubos de aspiración	539,578	DEBAKEY Micro-Pinzas	185
COOLEY Tubos de aspiración para CIRUGIA BARIATRICA	578	DEBAKEY Micro-Pinzas vasculares	185
COOPER Aguja para ligaduras	515	DEBAKEY Micro-Pinzas vasculares TITANIO	185
Copas graduadas	609	DEBAKEY Pinza vascular para CIRUGIA BARIATRICA	567
COPE Separador	322	DEBAKEY Pinza vasculares	157,158
CORN Pinza para suturas	507	DEBAKEY Pinza vasculares TITANIO	157,158
CORONAR Tijeras	80	DEBAKEY Pinzas para tejidos y organos	248
COTTLE (Millard) Ganchito nasal	308	DEBAKEY Pinzas vasculares PROMEDUR	165
COTTLE Gancho nasal	307	DEBAKEY Portas-agujas para CIRUGIA BARIATRICA	576
COTTLE Ganchos para las coanas	306,307	DEBAKEY Portas-agujas PROMEDUR	490,576
COTTLE Pinza para columnella	190	DEBAKEY Tijeras de disección	104
COTTLE Pinza para fijación	190	DEBAKEY Tijeras vasculares	109,133
COTTLE-ALAR Separador	308	DEBAKEY Tubos de aspiración	538
COTTLE-DORSAL Tijeras nasales	118	DEBAKEY-ADSON Pinzas de disección	142
COTTLE-MASING Tijeras nasales	119	DEBAKEY-CAROTID Clamp Bulldog	219
COX Separador para dedos	393	DEBAKEY-DOYEN Pinzas intestinales	256
CRAFOORD Pinzas hemostáticas	229	DEBAKEY-FEHLAND Pinzas intestinales	257
CRAFOORD Tijeras toracicas	107	DEBAKEY-FEMUR Separadores autostáticos	407
CRAFOORD-SELLORS Clamp para CIRUGIA BARIATRICA	569	DEBAKEY-GERALD Pinza de disección	145
CRAFOORD-SELLORS Pinzas hemostáticas	229	DEBAKEY-HAYES Pinzas intestinales	257
CRAWFORD Separadores	384	DEBAKEY-HEPARIN Cánulas	547
CRILE Ganchos para nervios	309	DEBAKEY-KOCHER Pinzas intestinales	256
CRILE Pinzas hemostáticas	222	DEBAKEY-MICRO Clamps Bulldog	217
CRILE Pinzas hemostáticas TITANIO	222	DEBAKEY-SATINSKY Clamps Bulldog	219
CRILE Porta-agujas	502	DEBAKEY-SCUDDER Pinzas intestinales	259
CRILE-BABY Pinzas hemostáticas	222	DEBAKEY-SELECT Portas-agujas	491
CRILE-COLLER Pinzas hemostáticas	224	DEBAKEY-WERTHEIM Pinzas-Clamps para histerectomia	275
CRILE-MURRAY Porta-agujas	502	DEJERINE Martillos de percusión	16
CRILE-WOOD Portas-agujas	489,502	DEMARTELL Tijera vascular	110
CRILE-WOOD Portas-agujas para CIRUGIA BARIATRICA	576	DENIS-BROWN Pinza intestinal	156
CRITCHETT Blefarostato	388	DENIS-BROWN Separadorea autostáticos	418
Cuadros para fijar paños	593,595,597,599,601	DENTAL Contenedores para esterilización	601
Cubetas	610	DENTAL Jeringas para cartucho-ampollas	552
Cuchara para medicinas	611	DERF Portas-agujas	488,501
Cuchillo para falanges	59	Dermatología	31-34
Cuchillos	57-60	Dermatomos	63-63
Cuchillos para amputación	59,60	DERMOT PIERSE Pinzas-fijación	195
Cuchillos para escayolas	556	D'ERRICO Gancho paras la raíz de nervios	314
Cuchillos para periostio	60	DESCHAMPS Agujas para ligaduras	514
Cuñas	610	DESJARDINS Exploradores para cálculos biliares	527
Curetas para huesos para CIRUGIA BARIATRICA	579	DESJARDINS Pinza-clamps para conducto biliar	262
Curetas para lupus	32	DESJARDINS Pinzas para cálculos biliares	264
CUSHING Espátulas cerebrales	460	DESMARRES Pinzas de chalazión	206
CUSHING Ganchos para decompresión	314	DESMARRES Retractores de párpados	304
CUSHING Ganchos para dura-madre	311	DICK Pinzas-Clamps de presión	271
CUSHING Ganchos para nervios	310	DIEFFENBACH Bulldog Clips	210
CUSHING Pinzas de disección	145	DIETHRICH Portas-agujas	500
CUSHING Pinzas de disección PROMEDUR	164	DIETRICH Clamps Bulldog	214
CUSHING Separador para CIRUGIA BARIATRICA	574	Dilatadores para el canal lacrimonal	521
CUSHING Separadores	324,574	Dilatadores vasculares	525
CUSHING Separadores para nervios	326	Dinamómetro	17,22
CZERNY Pinza para cuello uterino	276	DINGMAN Ganchos para zigoma	381
CZERNY Separador	331	Disecador para aspiración	536
		Dispensores de algodón	608
D		Distribuidores de filtros	603
DALE Pinza-gubias para CIRUGIA BARIATRICA	580	Distribuidores para cepillos	30
DANDY Ganchos para nervios	310	DOCKHORN Separadores para huesos	373
DANDY Pinzas hemostáticas	223	DOUGLAS Pinzas depilatorias	163
DANDY Tijera para dura-madre	111	DOUGLAS Trócar par el seno maxillar	542
DANDY-MOSQUITO Pinzas hemostáticas	223	DOYEN Pinza para campo	290
DARLING Separadores	407	DOYEN Pinza para polipos	265
DARTIGUES Pinza para el útero	283	DOYEN Pinzas intestinales	249
DASTOOR Pinzas para estrabismo	203	DOYEN Porta-agujas	501
DAVIDSON Separadores paras scápula	364	DOYEN Separador	345
		DOYEN Separadores abdominales	424

	Pàgina		Pàgina
DOYEN Sonda acánalada	523	FLETCHER (Javerts) Pinzas porta-esponjas	294
DOYEN Tijeras para ginegología	115	FLETCHER Pinzas porta-esponjas	293,294
DOYEN-DEBAKEY Pinzas intestinales	255	FOERSTER Pinza / esponjones para CIRUGIA BARIATRICA	573
DOYEN-STILLE Separadores	345	FOERSTER Pinzas para iris	192
DUBOIS Tijeras para decapitación	116	FOERSTER Separador abdominal p. rayos X	425
DUEHRSSSEN Pinzas de disección	145,152	FOMON Ganchos para las coanas	307
DUNHILL Pinzas hemostáticas	222	FOMON Tijera nasale	118
DUPLAY Pinza para cuello uterino	278	FOMON-DORSAL Tijeras nasales	118
DUPLAY Pinzas para tampones y torundas	296	FOSTER-GILLIES Portas-agujas	497
DUPLEX Estetoscopios	18	FOX Curetas para lupus	32
DURANTE Pinzas para vasos y tumores	155	FRANKLIN-SILVERMAN Agujas para biopsia	546
DUVAL Pinzas intestinales	156	FRAZIER Cánulas ventriculares	531,533
DUVAL Pinzas intestinales ATRAUMATICAS	247	FRAZIER Ganchos para dura-madre	311
DUVAL Pinzas intestinales PROMEDUR	247	FRAZIER Tubos de aspiración	533
DUVAL Pinzas intestinales y para tejidos	247	FREER Ganchito para la mucosa	306
E			
EICKEN-KILLIAN Cánulas lavadoras	535	FRITSCH Separadores	347
EISELSBERG Tijera para ligaduras	117	FUCHS pinza capsular	201
ELSCHNIG Pinza capsular	201	FUCHSIG Pinza hemostática	226
ELSCHNIG Pinza-fijación	196	FUKUSHIMA Tubos de aspiración	530
EMMET Ganchos para fistulas	327	G	
EMMET Pinza para tampones y esponjas	296	Ganchito vascular	315
ENGEL Sierra para yeso	556	Ganchitos finas	302-318
EPICARDIAL Separadores autostáticos TITANIO	392	Ganchitos finas para oftalmología	302-305
ERHARDT Pinza de entropión	204	Ganchitos finas para Rinología	306-308
ESMARCH Cuchillo para enyesados	556	Ganchitos para fistulas	327
ESMARCH Tijeras para vendajes	136	Ganchitos para venas	315
Espátulas cerebrales	459,460	Ganchitos vasculares	315
Espéculo abdominal	424	Gancho muscular	587
Espejos frontales	20	Gancho para cordón espermático	327
Estesiómetro	22	Ganchos para cripta	526
Estetoscopios	18	Ganchos para huesos	368-369
Estiletes con ojo	522	Ganchos para iris	302-305
Estiletes dobles	522	Ganchos para nervios	309-314
Estiletes dobles para CIRUGIA BARIATRICA	577	Ganchos para piel	31,302-303,315
Estiletes para el canal lacrimal	520	Ganchos para zigoma	381
Estiletes trabeculares	521	Garras fijadoras	303
Estribos para instrumentos	299	GARRETT Dilatadores vasculares	525
Estuche para suturas	508-511	GAUSS Pinza para pericráneo	284
Estuche plástica para OSCILLOW Sierras	560	GELPI Separadores	408
Estuchos para agujas	608	GELPI-BABY Separador	408
Etiquetas indicadoras	602	GELPI-MINI Separador	408
EWALD Pinzas de disección	142,148	GELPI-ORTHO Separador	409
EXACTA Manómetro	9	GELPI-SELETZ Separador	409
EXTRA ORAL Separador	380	GEMINI Pinza hemostatica para CIRUGIA BARIATRICA	571
EXTRA ORAL Separador con luz fria	380	GEMINI Pinzas hemostáticas	234
F			
FAHLBUSCH Micro-Tijeras	90	GEMINI-MINI Pinzas hemostáticas	234
FARABEUF Separadores	328	GERALD Pinza de disección TITANIO	145,151
FARRELL Portas-algodon	529	GERALD Pinzas de disección	145,151
FAURE Pinzas-Clamps para histerectomia	270	GERALD Pinzas de disección PROMEDUR	165
FAVALORO Tijera para arteria coronar	109	GERALD-DEBAKEY Pinza de dissección	145
FEHLAND Pinza intestinale	253	GEUDEL-NEGUS Laringoscopios	42
FEHLAND-DEBAKEY Pinzas intestinales	257	GILL Pinza para iris	193
FEILCHENFELD Pinzas para espinas	161	GILL-HESS Pinzas para iris	193
FELDHEIM compresor para dedos	32	GILLIES Ganchos para piel	31,315
Femur- Separadores autostáticos	407	GILLIES Pinza de disección	149
FERGUSON Tijera para ginegología	115	GILLIES Pinza de diseccion TITANIO	149
FERGUSON Tubos de aspiración	533	GILLIES Pinzas de disección PROMEDUR	165
FERGUSSON Pinzas-clamps de presión	261	GILLIES Portas-agujas	498,505
FERRIS-SMITH Pinzas con dientes	151	GILLIES-FOSTER Portas-agujas	497
FERROZELL Sondas conductoras	517	GILLIES-MINI Porta-agujas	505
Filtros, textil	604	GIL-VERNET Separadores maleable	325
Filtros,papel	603	GLASSMANN Pinzas vasculares	159
FINK Ganchos para piel	302	GLOVER Clamps Bulldog atraumaticas	212
FINOCCHIETTO Pinza para bronquios	239	GOELET Separador	331
FINOCHIETTO Portas-agujas	493,503	GOLDMAN-FOX Tijeras para encias	105,124
FINSEN Separadores autostáticos	391	GOLDSTEIN Separadores para saco lacrimal	390
FISCH Cánulas de aspiración	531	Goniómetros	22
FISH Sondas para seno	524	GOOD Tijeras para amígdalas	122
FISHER-ARLT Pinza para iris	191	GORNEY (Killian) Tijera para nariz	122
FLAGG Pinzas dentales	174	GORNEY Disecador para aspiración	536
		GORNEY Tijeras para cirugia plástica	106
		GOSSET Separadores abdominales	414
		GRADLE Tijeras para ligaduras	117
		GRAEFE Blefarostatos	388

	Pàgina		Pàgina
GRAEFE Gancho para estrabismo	304	HOLSCHER Gancho para nervios	313
GRAEFE Gancho para iris	302	HOLTZHEIMER Separadores autostáticos	392
GRAEFE Micro-Ganchitos	303	HOLZBACH Separador abdominal	413
GRAEFE Pinzas para iris	140,147,191	HOPKINS Cuchillo para enyesados	556
GRAEFE Pinzas para iris TITANIO	140	HORGAN valvas centrales	417
GRAEFE Pinzas-fijación	196	Horquilla para ligaduras	517
GRAEFE Tijeras oculares	68	HÖSEL Portas-agujas	497
GRAEFE-SELECT Pinzas para iris	140,147	HOUSE Tubos de aspiración	531
GRAHAM Gancho para nervios	309	HRYNTSCHAK Separador para la vejiga	465
Grapas para fijar paños	605	HULKA Pinza para cuello uterino	278
GRAY Pinzas-clamps para conducto biliar	263	HULKA-KENWICK Pinza para cuello uterino	278
GRAZIL Tijeras finas para cirugía	96	HUMBY Dermatómomo	63
GREEN Gancho para estrabismo	304	HUNT Pinza para tumores	179
GREEN Pinzas-fijación	196	HUNTER Pinzas para espinas	161
GREEN Separador para la glándula tiroidea	343		
GREEN-ARMYTAGE Pinzas uterina para hemostasis	284	I	
GREGORY Clamps Bulldog atraumaticas	213	I.M.A Mammaria Separador autostático	461
GREGORY Portas-agujas	482	ILIC Pinza cuticular	29
GROSS Pinzas para polipos	296	Infusión, Pinza par abrir betellas-	299
GRUENWALD Pinzas nasales	190	INGE Separadores para cuerpos vertebrales	444
GUILLEN Legra de succión	535	INGE-BABY Separadores para cuerpos vertebrales	443
GUILFORD Tijera para hilos	117	Instrumentos de medida	21-25
GUNNAR-HEY Pinza para drenaje	292	INTRA ORAL Separador	379
GUTHRIE Ganchos para piel	302	INTRA ORAL Separador con luz fria	379
GUYON Pinza renal para CIRUGIA BARIATRICA	571	INTRACARDIAC Portas-agujas	492
GUYON Pinzas-clamps para renal	266	IOWA Pinza vesical amniotica	285
		IRIS Tijeras	91,92
H		IRIS Tijeras con anillos grandes	92
HABERER Espátulas abdominales	355	IRIS Tijeras con anillos grandes	92
HALSEY Portas-agujas	488,501	IRIS Tijeras oculares	68
HALSEY-MICRO Portas-agujas	488	ISRAEL Separadores	337
HALSTED Pinzas hemostáticas	225		
HARMS Estiletes trabeculares	521	J	
HARRINGTON Pinza para bronquios para CIRUGIA BARIATRICA	572	JACKSON Separadores para tráquea	322
HARRINGTON Pinzas para bronquios	239	JACKSON-BURROWS Separador	409
HARRINGTON Separadores para el pulmón	361	JACOBS Pinzas para cuello uterino	280
HARRISON Pinzas para esterilización	298	JACOBSON Micro-Tijeras	82
HARTMANN Pinzas hemostáticas finas	220	JACOBSON Portas-agujas	481
HARTMANN Tubos de succión	535	JACOBSON-ADSON Pinzas de disección	176
HARTMANN-MICRO Pinzas hemostáticas finas	220	JACOBSON-MICRO Pinzas de disección	176
HARVEY Tijera para ligaduras	117	JACOBSON-MICRO Pinzas hemostáticas finas	221
HARVEY-JACKSON Separador	405	JAEGER Ganchos para tenotomia	304
HAYES-DEBAKEY Pinzas intestinales	257	JAMESON Calibrador	24
HEANEY Pinzas-Clamps para histerectomia	272	JAMESON Gancho para tenotomia	304
HEANEY Portas-agujas	494,504	JAMESON Pinzas musculares	204
HEANEY Separadores	362	JAMESON Tijeras finas de disección	104
HEANEY-KANTER Pinzas-Clamps para histerectomia	272	JAMESON-WERBER Tijeras finas de disección	104
HEANEY-REZAK Pinzas-Clamps para histerectomia	272	JANET Jeringas	550
HEATH (Hunt) Pinza de chalazión	207	JANSEN Separadores autostáticos	392
HEGEMANN Tijera vasculares	108	JEFFERSON Pinzas de disección	143,149
HEGENBARTH Pinza para poner grapas	506	Jeringa para irrigación	552
HEIFETZ Espátulas cerebrales	459	Jeringas	548-552
HEIFETZ Micro-Pinzas	187	Jeringas auto-rellenadas	551,552
HEIFETZ Pinzas para tumores	179	Jeringas con 3 anillos	549
HEISS Pinzas hemostáticas	226	Jeringas para cartuchos-ampollas	552
HEMILAMINECTOMIA Separadores autostáticos	396	Jeringas para las oídos	551
HENLEY Separadores	410	Jeringas para vejiga y heridas	550
HENNING Pinza para romper yeso	557	JOBSON-HORNE Portas-algodones	529
HENROTIN Pinza para cuello uterino	280	JOERGENSON Tijeras de disección	99
HENRY Pinza depilatoria	163	JOHN-HOPKINS Bulldog Clips	210
HERMANN Separador para vendajes	557	JOHN-HOPKINS Pinza para poner clips	210
HERRICK Pinza-clamp renal	266	JOHN-HOPKINS Pinza-clamps para conducto biliar	263
HERTZLER Separador abdominal	415	JOHNSON Porta-agujas	503
HESS Pinzas capsulares	201	JOLL (Friedmann) Separador para tiroides y vagina	407
HESS Pinzas para iris	194	JONES Pinzas para campo	290
HEYMANN Tijeras nasales	118	JOSEPH Gancho para mucosa	306
HEYWOOD-SMITH Pinzas para polipos	285	JOSEPH Tijeras para cirugía plástica	121
HIBBS Separadores	362	JUDD-ALLIS Pinzas intestinales y para tejidos	244
HIBBS Valvas para laminectomia	438	JUDD-MASON Separador para la vejiga	465
HOEN Gancho para nervios	309	JUDD-MASON Separador vesical	464
HOEN Pinzas para neurocirugía	175	Juego de manicura p.enfermeras	30
HOEN Separador para la columna cervical	432	Juegos Diagnósticos	11-15
HOESEL Separadores	346	JULIAN Portas-agujas	491
Hojas de afeitar	64		
Hojas de bisturíes	47-51		

	Página		Página
K			
KADER Espátula abdominales	354	LANE Pinzas para campo	291
KALT Pinza capsular	201	LANE-TRETHOWAN Elevador para huesos	368
KALT Portas-agujas	471	LANGE Gancho nasal	307
KATSCH Sacca-Comedones	31	LANGENBECK Cuchillo para amputación	59
KATZIN Tijeras para cornea	73	LANGENBECK Cuchillos para resección	60
KATZIN-BARRAQUER Tijeas oculares	73	LANGENBECK Portas-agujas	493
KAYE Portas-agujas	498,499	LANGENBECK Separadores	339,340
KAYE Tijeras para transplantaciones	120	LANGENBECK-MINI Separadores	323
KELLY Pinza para ovarios y pólipos	287	Laringoscopios	37-46
KELLY Pinza para polipos	285	LATERAL Separador vaginal	466
KELLY Pinzas hemostáticas	222,230	LAWRENCE Pinza de disección y ligaduras	235
KELLY Pinzas hemostáticas TITANANIO	222	LAZAR Micro-Pinzas para suturas	160
KELLY Separadores	344	LEGUEU Separador vesical	412
KELLY Tijeras para vasos y fistulas	95,134	LEMPERT Pinza cuticular	29
KELMAN-McPHERSON Pinza para suturas	199	LERCHE Pinza con dientes	153
KERSTING Pinzas intestinales	258	LERICHE Espátula abdominal	356
KEYES Trépanos cutáneos	32	LERMOYES Trócares par el seno maxillar	542
KILLIAN Canula lavadora	535	LESTER Pinzas-fijación	196
KILNER (Ragnell) Tijeras finas de disección	120,124	LeVASSEUR-MERRILL Separadores extra orales	381
KILNER Gancho para piel	31,315	LEXER-BABY Tijeras	100
KILNER Gancho paralas coanas	308	LEYLA porta-especulos auriculares	456
KILNER Portas-agujas	488,501	LEYLA Separadores (Sistema)	455-458
KILNER Tijeras finas de disección	119	LICHTENBERG Porta-agujas	496
KIRKLIN Separadores maleable	324	LICHTWITZ Trócar par el seno maxillar	541
KIRSCH Separadores para huesos	373	LIEBERMANN Blefarostatos	390
KIRSCHNER Quadro plegable	419,420	Ligaduras, agujas para-	513-515
KIRSCHNER Separadores abdominales	519,420	Ligaduras, Tijeras PROMEDUR	134
KIRSTEIN (Heymann) Tijeras nasales	118	Limas para uñas	30
KLAPP Separadores	320	LISTER Tijeras para vendajes	135
KLEINERT-KUTZ Ganchos para piel	31,315	LISTER-BURCH Blefarostato	389
KLIMA-ROSEGGER Aguja para punción	545	LISTER-EXCENTRIC Tijeras para vendajes	135
KLINGENBERG-LOTH Tijera de disección	107	LISTER-SINUS Pinzas para tampones y torundas	295
KLING-EX Extractor-hojas	50	LISTON Cuchillos para amputación	59
KLINIKUM BERLIN Pinza para tubos	292	LITTAUER Pinza depilatoria	163
KNAPP Ganchos para piel	302	LITTAUER Pinzas cuticulares	28
KNAPP Pinza para tracoma	204	LITTAUER Tijera para ligaduras	117
KNAPP Tijeras oculares	67	LITTLE Separador	337
KNOWLES Tijeras para vendajes	135	LITTLEWOOD Pinzas intestinales y para tejidos	244
KOCHER (ROCH.-OCHSNER) Pinzas hemostáticas	232	LLOYD-DAVIS Pinza-clamp para anastomosis	261
KOCHER Pinzas hemostáticas	231	LLOYD-DAVIS Tijera para recto	113
KOCHER Pinzas intestinales	250	Localizador	302
KOCHER Separadores	338,341,342	LOCKHART-MUMMERY Sondas para fistulas	523
KOCHER-BABY Pinzas intestinales	249	LOCKLIN Tijeras para encias	106,134
KOCHER-DEBAKEY Pinzas intestinales	256	LOCKWOOD Pinza intestinal	245
KOCHER-FINO Pinzas hemostáticas	231	LONDON-COLLEGE Pinzas dentales	173
KOCHER-WAGNER Separadores	347	LORDAN Pinza de chalazión	207
KOENIG Separadores	320	LORENZ Tijeras para vendajes	135
KOENIG Sondas conductoras	516	LORNA Pinzas para campo	291
KOENIG Tijeras para hender las uñas	33	LOVE Ganchos para nervios	312
KOERTE Espátulas abdominales	356	LOVELACE Pinzas hemostáticas	223
KOERTE Separadores	336	LOVELACE Pinzas para bronquios y pulmon	241
KOGAN Endospéculos	466	LOWER Pinzas-clamps para conducto biliar	263
KONRICH Tambores de esterilización	607	Lubrificante para instrumentos	608
KRAUSE Trócar par el seno maxillar	542	LUCAE Ganchitos auriculares	305
KRONECKER Agujas para ligaduras	515	LUCAE Pinzas auriculares	189
KUEHNE Pinzas porta-laminillas	162	LUCAE Pinzas para el timo	322
KUEMMEL Espátula abdominal	356	LUKENS Separador para el timo	322
KUESTNER Pinza para cuello uterino	281	Lupas frontales binoculares	19
		LURZ Pinzas para ureter	269
L		M	
LA GRANGE Tijeras para esclerectomia	69	MAGILL Cánulas lavadoras	536
LAHEY Gancho para dura-madre	311	MAGILL Pinzas para cateteres	36
LAHEY Pinza-clamps para conducto biliar	262	MAIER Pinzas para polipos	296
LAHEY Separador para bocio	337	MALTZ Gancho nasal	307
LAHEY-METZENBAUM Tijeras de disección	101	Mangos de bisturios	50-56
LAMBERT Pinza de chalazión	206	MANNERFELT Separadores	316-317
LAMBOTTE Separador para huesos	368	MANNERFELT-LANGENBECK Separadores	317
LANCASTER Blefarostato	389	MARBERGER Separadores maleable	325
LANDAU Trócar	542	MARINUS Pinzas intestinales	260
LANDOLD Mangos de bisturios	51	MARKHAM-MEYERDING Separadores	406
LANE Elevador para huesos	368	MARSCHIK Pinzas para coger amígdalas	238
LANE Pinzas con dientes	154	MARTEL Pinza para pericráneo	284
LANE Pinzas intestinales	254	Martillos de percusión	16
		MARTIN Pelvimetro	25
		MARTIN pinza para desechos	298

MARTIN Separador	348	MILLER Laringoscopios	39
MARTIN Tijera para cartilago	123	MILLER Laringoscopios con luz fria	46
MASSON Portas-agujas	494,504	MILLER Separadores	318
MATHIEU Espéculo rectal	462	MILLER Tijera para recto	112
MATHIEU Portas-agujas	496,505	MILLER-BABY Laringoscopio	38
MATHIEU Separadores	321,330	MILLER-BABY Laringoscopio con luz fria	46
MATHIEU-KOCHER Portas-agujas	496	MILLES Micro-Tijeras	82
MATHIEU-SLIM Porta-agujas	505	MILLES Micro-Tijeras	88
MAYO Portas-Instrumentos	299	MILLIGAN Separador	398
MAYO Tijeras de disección	98,125	MILLIN Dilatador para el cuello vesical	464
MAYO Tijeras para CIRUGIA BARIATRICA	565	MILLIN Separador para la vejiga	464
MAYO-ADAMS Separador abdominal	412	MILLS Tijera vascular	110
MAYO-BLAKE Pinzas para cálculos biliares	265	Mini Clips	210,211
MAYO-GUYON Pinzas-clamps para renal	266	Mini-Bulldog Clips	211
MAYO-HARRINGTON Tijeras de disección	99,126	Mini-clips vasculares	210
MAYO-HEGAR Portas-agujas	490,502,576	MINI-GELPI Separador	408
MAYO-HEGAR Portas-agujas para CIRUGIA BARIATRICA	576	MINI-GILLIES Portas-agujas	498,505
MAYO-HEGAR Portas-agujas PROMEDUR	490	MINI-LANGENBECK Separadores	323
MAYO-LEXER Tijeras de disección	99,126	MINIMUS Manómetro	9
MAYO-LEXER Tijeras de disección PROMEDUR	126	MINI-ROUX Separador	330
MAYO-NOBLE Tijeras de disección	99	MINI-RYDER Portas-agujas	499
MAYO-ROBSON Pinzas intestinales	251	MISKIMON Separador para laminectomia	433
MAYO-RUSSIAN Pinza para vasos y tumores	154	MIXTER Explorador para calculos biliares	527
MAYO-STILLE Tijeras de disección	98,125	MIXTER Pinza-clamps para conducto biliar	263
MAYO-STILLE Tijeras de disección PROMEDUR	125	MIXTER Pinzas de disección y ligaduras	236
Mazo para autopsia	587	MIXTER Pinzas para cálculos biliares	265
McCOLLOUGH Pinzas para estrabismo	202	MIXTER Tijeras finas para cirugía	95
McGUIRE Tijeras para córnea	67	MIXTER-BABY Pinzas de disección y ligaduras	235
McINDOE Pinza de disección	143	MIXTER-O'SHAUGHNESSY Pinzas hemostáticas	233
McINDOE Pinza de disección TITANIO	143	MOBERG Separadores	320
McINDOE Pinzas de disección PROMEDUR	165	MOCK Cánula para Heparin	547
McINDOE Tijeras para cirugía plástica	122	Modelo sueco Porta-agujas	499
McINTOSH Laringoscopio con luz fria	43-44	MODULAR Sistema Retractor	439-441
McINTOSH Laringoscopios	37-38	MOELTGEN Goniómetro	22
McPHERSON Pinzas para suturas	199	MOLLISON Separador	398
Medidores para tornillos	24	MOORFIELD Pinza para suturas	200
MEEKER Pinza de disección y ligaduras	235	MORRIS Separadores	331,345
MELLINGER Blefarostatos	389	MORRIS-MITRAL Separador vascular	409
MELLINGER-AXENFELD Blefarostatos	389	MOSQUITO Pinzas hemostáticas finas	221
MEMORY Espátulas cerebrales	460	MOSQUITO Pinzas hemostáticas finas para ZURDOS	221
MENGHINI Cánulas para biopsia	545	MOSQUITO Pinzas hemostáticas TITANIO	221
MERIAM Pinzas dentales	174	MOSQUITO-MICRO Pinzas hemostáticas	221
Mesura, Instrumentos-	21-25	MOYNIHAN Explorador para calculos	527
METZENBAUM Porta-agujas	503	MOYNIHAN Pinza para campo	291
METZENBAUM Tijeras de disección	101-103,128-132	MOYNIHAN Pinza-clamps para conducto biliar	262
METZENBAUM Tijeras de disección PROMEDUR	128-132	MUELLER Blefarostato	389
METZENBAUM Tijeras para CIRUGIA BARIATRICA	564	MULDOON Dilatadore para canal lacrimal	521
METZENBAUM-BABY Tijeras de disección	100	MURDOCK Blefarostato	388
METZENBAUM-FINO Tijeras de disección	103,130,132	MURPHY Separadores	335
MEYERDING Separadores	319,348	MUSEUX Pinzas para cuello uterino	281
MEYERDING Separadores autostáticos	406	MUY LIGERO Clamps Bulldog atraumaticas	215
MEYERDING Valvas para laminectomia	438		
MEYER-SCHWICKERATH Localizador	302	N	
MICHEL Agrafes (Grapas)	507	NABATOFF Juego para várices	543
MICHEL Estucha para sutura	508	NAGEL Micro-Tijeras	87
MICHEL Pinzas para poner y quitar grapas	506	NAUNTON-MORGAN Porta-agujas	495
Micro Pinzas de disección	141,176-188	Navaja 61	
Micro Separadores autostáticos	388-392	NEGUS Pinzas para amígdalas	237
MICRO-CASTROVIEJO Portas-agujas	473	NEIVERT Gancho paralas coanas	307
MICRO-HALSEY Portas-agujas	488	NEIVERT Porta-agujas	502
MICRO-MOSQUITO Pinzas hemostáticas	221	NELATON Sonda acanalada	523
Micro-Pinzas con contrapeso	180,181,184	NELSON Pinzas con dientes	153
Micro-Pinzas con dientes	147	NELSON Trócares	541
Micro-Pinzas con ojal	184,187-188	NEW ORLEANS Portas-agujas	491
Micro-Pinzas con puntas diamantadas	180-185	NEWS Separador para tráquea	322
Micro-Pinzas para suturas	178,180-183	NICOLA Micro-Tijeras	90
Micro-Pinzas TITANIO	180-185	NISSEN Pinza hemostática	226
Micro-Tijeras oculares	70	NORFOLK-NORWICH Separador	397
MICRO-VANNAS Tijeras	76,77	NOTO Pinza para pólipos uterinos	286
Micro-Vascular Portas-agujas	489,491	NOYES Tijeras para iridectomia	70
Micro-Vascular Tijeras	107	NUGENT Pinzas para estrabismo	203
MIDDELDORF Separadores	342,343	NUSSBAUM Pinzas intestinales	252
MIKULICZ Pinza-clamps para peritoneo	270		
MIKULICZ Separadores	348,349		
MIKULICZ-BABY Pinzas-Clamps para hysterectomia	270		

	Pàgina		Pàgina
O			
O'BRIEN Tijera para ligaduras	117	Pinza-fixajión canal espermática	269
OBWEGESER Gancho para el menton	377	Pinzas arrance-uñas	33
OBWEGESER Separador para el ramo	375	Pinzas auriculares	189
OBWEGESER Separadores	371-372	Pinzas bipolares para coagulación	167-171
OBWEGESER Separadores acanalados	377	Pinzas capsulares	200-201
OBWEGESER Separadores para el ramo	374	Pinzas con dientes	150-155
OBWEGESER Separadores para spina nasalis	374	Pinzas con dientes	150
OCHSNER Pinza para suturas	507	Pinzas con dientes para CIRUGIA BARIATRICA	566
OCHSNER Trócares	541	Pinzas conjuntivales	193
O'CONNOR Gancho para iris	302	Pinzas corta-uñas	28
O'CONNOR Pinza conjuntival	193	Pinzas corta-uñas	28
OCULUS Lupas frontales	19	Pinzas cuticulares	28-29
OEHLER Pinzas de disección PROMEDUR	166	Pinzas de chalazión	206-207
Oftalmoscopios	11-14	Pinzas de disección para CIRUGIA BARIATRICA	560,561
OLDBERG Separadores para nervios	314	Pinzas de disección PROMEDUR	164-166
Olio para instrumentos	608	Pinzas de disección TITANIO	144
OLIVECRONA Espátulas cerebrales	460	Pinzas de disección	144-146
OLIVECRONA Tijera para nervio trigémino	111	Pinzas de disección con dientes	150-154
OLLIER Separadores	336	Pinzas de disección para neurocirugia	175-180
OLSEN-HEGAR Portas-agujas	498,505	Pinzas de disección TITANIO	140,142-146,148,149,151,153,157-158
OLVECRONA Pinzas hemostáticas	229	Pinzas de fijación	195-197
OMBREDANNE Pinza intestinal	245	Pinzas dentales	173-174
ONG Tijeras para iridectomia	71	Pinzas depilatorias	163
ORL Juegos diagnósticos	11-12,14	Pinzas episcleral	197
OSCILLOW-E.P. Sierras electricas para yeso	558-560	Pinzas finas de disección	142-144,150
O'SULLIVAN-O'CONNOR Separador para CIRUGIA BARIATRICA	575	Pinzas finas de disección con dientes	147-149
O'SULLIVAN-O'CONNOR Separadores abdominales	422,575	Pinzas hemostáticas	227-233,236,268
Otoscopios	11-15	Pinzas hemostáticas finas	220-226,234-235
OVERHOLT-BABY Pinza hemostática	233	Pinzas hemostáticas finas para ZURDOS	221
OVERHOLT-GEISSENDOERFER Pinzas hemostáticas	233	Pinzas hemostáticas finas TITANIO	221,222
OVERHOLT-MIXTER Pinza hemostática	233	Pinzas hemostáticas para CIRUGIA BARIATRICA	567-573
		Pinzas intestinales y para tejidos	156
		Pinzas- Iris	140
		Pinzas musculares	204,205
		Pinzas nasales	190
		Pinzas para aborto y placenta	287
P		Pinzas para amígdalas	237-238
Paños de esterilización	604	Pinzas para bronquios	239,240
Parametrium, Tijeras-	127	Pinzas para bronquios y pulmon	239-242
PARK Blefarostato	389	Pinzas para campo	290-291
PARKER bisturios	58	Pinzas para cateteres	36
PARKER Separadores	328	Pinzas para chalazion	204-206
PARKER-LANGENBECK (US-Army) Separadores	329	Pinzas para coagulación bipolar	167-171
PARKER-MOTT Separadores	329	Pinzas para coger	154-156
PARK-GUYTON Blefarostato	389	Pinzas para coger el pulmón	154
PARK-MAUMENEE Blefarostato	389	Pinzas para disección y ligaduras	233-236
PAUFIQUE Pinzas para suturas	198	Pinzas para drenaje	292
PAYR Sondas conductoras	516	Pinzas para el útero	282-283
PEAN Pinzas hemostáticas	227	Pinzas para espinas	161,162
PEAN-FINO Pinzas hemostáticas	228	Pinzas para esponjas	293-296
PECK-JOSEPH Tijeras finas de disección	105	Pinzas para esponjas para CIRUGIA BARIATRICA	573
PEERS Pinza para campo	290	Pinzas para esterilización	298-299
PEET Pinza para espinas	162	Pinzas para estrabismo	202-203
PELKMANN Pinzas para tampones y torundas	295	Pinzas para hipofisis	175
Pelvimetros	25	Pinzas para la cámara anterior	202
PENNIGNTON Pinzas intestinales y para tejidos	243	Pinzas para ligaduras	160
Percusión, Martillos-	16	Pinzas para microscopia	141,161
Perforador para dedos	33	Pinzas para oftalmologia	191-207
Periostótomos para CIRUGIA BARIATRICA	579	Pinzas para pólipos uterinos	285-286
PERKINS Separadores	399	Pinzas para romper yeso	557
PERWITZSCHKY Tijera para el canal salivar	123	Pinzas para suturas	198-201,507
PETRI cubeta	609	Pinzas para tampones y torundas	293-297
PHANEUF Pinza-camp para histerectomia	271	Pinzas para tejidos y organes	243-248
PIERCE Trócares par el seno maxillar	542	Pinzas para tracoma	204
PIERSE-COLIBRI Pinza-fijación	195	Pinzas para tubos	292
PIFFARD Curetas para lupus	32	Pinzas para uréter	268,269
PINARD Estetoscopios	18	Pinzas para uréter atraumaticas	268
Piñon para fijar instrumental	606	Pinzas para vendajes	610
Piñon para fijar separadores	606	Pinzas porta-esponjas	293-294
Pinza para abrir botellas de infusión	299	Pinzas porta-laminilla	162
Pinza para coger prostata	269	Pinzas portar y romper hojas de afeitar	64
Pinza para columnela	190	Pinzas tira-lengua	36
Pinza para medir huseos	23	Pinzas úterinas para hemostasis	264
Pinza para poner Mini-clips	210	Pinzas vasculares con bocas atraumáticas	158-160
Pinza para poner y quitar clips Bulldog	216	Pinzas-Clamps de presión	261,271
Pinza para sostener el niño	268		
Pinza rompe membrana	285		

	Página		Pàgina
Pinzas-Clamps intestinales	249-261	RAMSAY Pinzas de disección	145,152
Pinzas-Clamps intestinales atraumáticas	255-261	RANDALL Pinzas para cálculos renales	267
Pinzas-Clamps para calculos biliares	264-265	RANKIN-CRILE Pinzas hemostáticas	224
Pinzas-Clamps para calculos renales	267-268	RANKIN-KELLY Pinzas hemostáticas	224
Pinzas-Clamps para coger el cuello del útero	276-281	Rascador para lupus	31
Pinzas-Clamps para conducto biliar	262-263	Recipientes para algodón	608
Pinzas-Clamps para histerectomia	272-275	RECORD Jeringas Luer	548
Pinzas-Clamps para peritoneo	271	RECORD Jeringas Luer-Lock	548
Pinzas-Clamps para renales	266	REDON Agujas-guía	540
Pinzas-fijación	190,194-194	Reglas	22
Pinzas-Gubias para CIRUGIA BARIATRICA	580	REILL Micro Portas-agujas	474
Placas de identificación	602	REINER Cuchillo para enyesados	556
PLESTER Cánulas de aspiración	534	RESANO Pinzas intestinales	258
PLESTER Separadores autostáticos	393	RESANO Tijera para cartilago	123
PLEY Blefarostato	389	Retractor para la tráquea	391
POCKET-ASSISTENT Estuche para suturas	511	Retractores de párpados	304,324
POCKET-MINI Estuche para suturas	509	REVERDIN Agujas para ligaduras	513
POCKET-MULTI Estuche para suturas	510	REVERDIN Espátula abdominales	355
POCKET-VENAE-SECTIO Estuche	512	REYNOLDS Tijeras finas de disección	104
POLLOSON Espátulas para el pulmón	365,366	RHOTON Micro-Pinzas	180-184
POOLE Tubos de aspiración	538,538	RIBBON Espátula abdominales	355
POOLE Tubos de aspiración Para CIRUGIA BARIATRICA	578	RIBBON Tijeras para estrabismo	66
Porta-agujas para CIRUGIA BARIATRICA	576,577	RIBBON Tijeras para suturas	66
Porta-instrumentos para Micro Instrumentos	606	RIBBON-IRIS Tijeras	66
Portas-agujas	470-504,576	RIBBON-KAYE Tijeras blefaroplasticas	66
Portas-agujas con doble articulación	482,495	RIBBON-STEVENS Tijeras para tenotomia	66
Portas-agujas con puntas diamantadas	482-485,489,491	RICARD Separadores abdominales	413
Portas-agujas con tijeras	497,498,505	RICHARDSON Separadores	343
Portas-agujas para CIRUGIA BARIATRICA	576	RICHARDSON-EASTMAN Separadores	343
Portas-agujas para oftalmologia	472-473	RICHTER-HEATH Pinza para quitar agrafes	507
Portas-agujas para ZURDOS	488,489,490,505	RIGBY Separadores	410
Portas-agujas PROMEDUR	470-471,479-480,481,488-500	RITTER-HALLE Dilatadores para seno frontal	524
Portas-agujas TITANIO	483-485,489,491	ROBERTS Pinza hemostática	228
Portas-agujas, Micro-	470-486	ROBIN-MASSE Separador abdominal	414
Portas-algodones	529	ROCHARD Separadores abdominales	423
Portas-hojas	64	ROCHESTER-CARMALT Pinzas hemostáticas	227
POST MORTEM Agujas	588	ROCHESTER-OCHSNER Pinzas hemostáticas	232
POST-MORTEM Caja/Instrumentos	584	ROCHESTER-OCHSNER Pinzas para CIRUGIA BARIATRICA	570
POST-MORTEM Hojas	50	ROCHESTER-PEAN Pinzas hemostáticas	228
POST-MORTEM Ostéotomo	587	ROCHESTER-PEAN Pinzas para CIRUGIA BARIATRICA	568
POTTS Tijeras finas para disección	94	ROEDER Pinzas para campo	291
POTTS-DE-MARTEL Tijeras vasculares	110	ROGGE Pinzas para esterilización	298
POTTS-SMITH Pinzas de disección	145,146,152	ROLLET Gancho para piel	302
POTTS-SMITH Pinzas de disección PROMEDUR	164	ROSE Separador para tráquea	322
POTTS-SMITH Tijeras vasculares	108,109,133	ROSEN Cánulas de aspiración	534
POTTS-YASARGIL Micro-Tijeras	88	ROSS Separadores para aorta	384
POZZI Pinza para cuello uterino	277	ROUX Separadores	330
PRATT Ganchos para cripta	526	ROUX-BABY Separador	330
PRATT Pinza para cuello uterino	280	ROUX-MINI Separador	330
PRATT Sondas para fustulas	526	RUMEL Pinzas de disección y ligaduras	234
PRATT-"T" Pinza para tejidos y organos	248	RUSSIAN Pinza disección para CIRUGIA BARIATRICA	566
Precintos de seguridad	602	RUSSIAN Pinzas para vasos y tumores	154
PRECISA Manómetro	8	RYDER Portas-agujas	499
Preparación	28-30	RYDER-MINI Portas-agujas	499
PRESBYTERIAN Pinzas para tubos	292	RYDER-MINI-SELECT Portas-agujas	500
PRICE-THOMAS Pinzas para bronquios	240		
PRINCE Pinzas musculares	205	S	
PRINCE Tijeras para amígdalas	122	SAALFELD Saca-Comedones	31
PRO-MED Porta-agujas	499	Saca-comedones	31
PRO-MED SELECT Sierras para abrir anillos	34	SACHS Gancho para dura-madre	310
PRO-MED Separador para laminectomia	442	SAENGER Pinzas para aborto y placenta	287
PRO-MED Sierras para abrir anillos	34	SAMII Micro-Pinzas forma cuchara	188
PROVIDENCE-HOSPITAL Pinzas hemostáticas	222	SANTULLI Clamp Bulldog	214
		SANVENERO Tijeras para cirugia plástica	121
Q		SAROT Pinzas hemostáticas	230
QUINBY Tijera para encias	121	SAROT Pinzas hemostáticas para CIRUGIA BARIATRICA	569
QUINCKE Agujas para biopsia spinal	545	SAROT Pinzas para bronquios	239
		SAROT Portas-agujas	495,504
R		SATINSKY Pinzas-Clamps para anastomosis	242
Rachiotómo	587	SATINSKY Tijera para la vena cava	107
RADOLF Pinza arrance-uñas	33	SAUER Blesfarostato	388
RAGNELL Separador	321	SAUERBRUCH Estucho para agujas	609
RAMEL Aguja para biopsia-pleura	546	SAUERBRUCH Pinza para desechos	298
RAMPLEY Pinzas porta-esponjas	294	SAUERBRUCH Separadores	349
		SAWTELL Pinzas para amígdalas	237

	Página		Página
SCALP-CONTOUR Separadores autostáticos	393	Separadores vesicales	465-465
SCHAEDEL Pinza para campo	290	SEUTIN Cizallas para encayolas	138
SCHAMBERG Saca-comedones	31	SEXTON Separador	401
SCHIMMELBUSCH Tambores de esterilización	607	SHAAF Pinza para cuerpos extraños	163
SCHINK Dermatomo	62	SHEA Separador de aplicaciones varias	381
SCHMID Cánulas para irrigación	536	SHEA Tijeras para transplantaciones	120
SCHMIEDEN-TAYLOR Tijera para dura-madre	111	SIEBENMANN Cánulas lavadoras	536
SCHNIDT Pinzas para amígdalas	237	SIEBOLD Tijera uterina	115
SCHOEMAKER Tijeras para bocio	123	Sierras eléctricas para yesos	558-560
SCHOEMAKER-LOTH Tijera para ligaduras	117	Sierras para autopsia	585
SCHROEDER Pinzas para cuello uterino	277,279	Sierras para yeso	556
SCHUKNECHT Separador	399	SILVER Dermatomo	63
SCHUMACHER Tijera umbilical	116	SIMON bisturios	58
SCHWARTZ Bulldog Clips	211	SIMON Ganchos para fistulas	327
SCHWARTZ Pinza para poner clips	211	SIMS Tijeras uterinas	114,126
SCHWEIGGER Pinzas para suturas	200	SIMS-MAIER Pinzas para tampones y torundas	295
SCOVILLE Espátulas cérebrales	459	SINGLEY (TUTTLE) Pinza para CIRUGIA BARIATRICA	154,567
SCOVILLE Gancho paras la raíz de nervios	312	SKENE Pinza para cuello uterino	279
SCOVILLE Pinza cérebrales	175	SMILLIE Separadores para rodilla	370
SCOVILLE Separador para laminectomia	436	SMITH Blefarostato	388
SCOVILLE-HAVERFIELD Separador para laminectomia	437	SMITH Tijera para ligaduras PROMEDUR	134
SCOVILLE-RICHTER Separador para laminectomia	435	SMITH(US-ARMY) Tijeras para vendajes	136
SCUDDER Pinzas intestinales	251	SMITH-BUIE Espéculo rectal	463
SCUDDER-DEBAKEY Pinzas intestinales	259	SMITHWICK Ganchos para nervios	310
SCULPO Separadores	367	SNELLEN Pinzas de entropión	204
SEGOND Pinzas-Clamps para histerectomia	272	SOFIELD Separadores	331
SEGOND-LANDAU Pinzas-Clamps para histerectomia	272	SOMER Pinza para el útero	282
SELECT Pinzas para microscopia	141	Sondas acánaladas	523
SEMB Pinzas de disección y ligaduras	241	Sondas acánaladas abotonadas	523
SEMKEN Pinzas de disección	143,149	Sondas auriculares y para seno	524
SEMKEN Pinzas de disección PROMEDUR	164	Sondas conductoras	516-517
SEMKEN Pinzas de disección TITANIO	143	Sondas exploradoras	520-526
SEMM Separador abdominal	421	Sondas forma mirto	523
SENN-GREEN Separadores	323	Sondas irrigadoras	535
SENN-MILLER Separadores	321	Sondas para el conducto biliar	527-528
SENN-MILLER-BABY Separadores	321	Sondas para fistulas	523,526
Separador horizontal	401	Sondas vasculares	525
Separador para dedos	393	Spatulas abdominales	354-360
Separador para huesos	335	Spatulas pare el pulmon	361,363-366
Separador para I.M.A.	41	SPENCER Tijeras para ligaduras	117
Separador para la glándula tiroidea	343	SPENCER-WELLS Pinzas hemostáticas	227
Separador para tiroides y vagina	407	SPERMATIC Pinza-fixacion canal espermatica	269
Separadores autostaticos	347-466	St.MARKS Separador para el recto	463
Separadores autostáticos	388-466	St.MARKS Separadores para pelvis	360
Separadores autostaticos "MODULAR"	439-441	St.MARTIN Pinza para suturas	198
Separadores autostaticos abdominales	411-429	STACKE Sonda auricular	524
Separadores autostaticos para hemi-laminectomía	396	STAUDE-MOORE Pinza para cuello uterino	276
Separadores autostaticos para laminectomía	402-407,430-438,442	STEINHÄUSER Separadores cigomáticos	373
Separadores autostaticos para ortopedia	409	STELZNER Tijeras para recto	113
Separadores autostaticos vasculares	409	STEVENS Gancho para tenotomia	304
Separadores con dientes	332-337	STEVENS Pinzas para iris	191
Separadores dobles	321-322,328-331	STEVENS Portas-agujas	472
Separadores en forma de selle	324-326	STEVENS Tijeras para tenotomia	93
Separadores endocervicales	466	STEVENSON Blefarostato	389
Separadores epicardiales	392	STIEGLITZ Pinzas para espinas	162
Separadores espinales	309,362	STILLE Cizallas para encayolas	137
Separadores finas con dientes	318-319	STILLE Pinza-clamp para renal	266
Separadores finas flexibles con dientes	318	STILLE Pinzas de disección	144
Separadores finas para la tráquea	318	STILLE-BARRAYA Pinzas para vasos y tumores	155
Separadores para aorta y adrio	382-384	STILLE-HAGLUND Separador para vendajes	557
Separadores para CIRUGIA BARIATRICA	574-575	STONE Pinza con dientes	153
Separadores para cirugia maxilo-facial	371-381	STRANDELL-STILLE Separadores	320
Separadores para cuerpos vertebrales	443-445	STRATTE Portas-agujas	495,504
Separadores para el ramo	374-375	STRINGER estribos para instrumentos	299
Separadores para esterilización	606	STRULLY Tijera para neurocirugia	111
Separadores para femur	407	Sujetafiltros	603
Separadores para huesos	368-370	SYSTRUNK Tijeras corta-uñas	33
Separadores para la columna cervical	447-449		
Separadores para la micro-dissectomia lombar	450-453	T	
Separadores para la vulva	408-409	Tabiques para cajas de esterilización	593,595,597
Separadores para mejillas	373	Tambores de esterilización	607
Separadores para rodilla	370	Tapices portas instrumentos de silicona	604
Separadores para yeso	557	Tarros	611
Separadores rectales	462-463	TAYLOR Martillo de percusión	16
Separadores SCULPO	367	TAYLOR Pinzas de disección	146,152

	Página		Página
TAYLOR Pinzas de disección TITANIO	146	TOENNIS Tijeras de disección	104
TAYLOR Separadores espinales	309	TOENNIS-ADSON Tijeras SUPERCUT	104
TAYLOR Valvas para laminectomía	438	TOENNIS-RYDER Portas-agujas	492
TAYLOR-CUSHING Pinzas de disección	146,152	TOHOKU Pinzas para campo	291
TEALE Pinzas para cuello uterino	281	Transformador	20
TEMPLE-FAY Separador para laminectomía	436	TRIVERS Separador	397
Tensiómetros	8-10	Trépanos cutáneos	32
TERSON pinza capsular	201	TREVES Pinzas con dientes	153
THOMS-ALLIS Pinza intestinal	244	Trócares	541-542
THOMSON-WALKER Separador para la vejiga	465	TROELTSCH Pinza para compresión	190
THOREK (HALLE) Tijeras de disección	100	TROELTSCH Pinzas auriculares	189
THOREK Tijeras torácicas	100	TROELTSCH Pinzas nasales	190
THORPE (Marchac) calibrador	24	TROEMNER Martillo de percusión	16
TIEMANN Pinza para cuello uterino	279	TROUTMAN Pinza para iris	194
Tijera umbilical USA-Modelo	116	TROUTMAN Portas-hojas	64
Tijeras	65-136,564-565	TROUTMAN Tijeras para cornea	73
Tijeras corta-uñas	28,33	TROUTMAN-BARRAQUER Portas-agujas	472
Tijeras cuticulares	28	TROUTMAN-RECTUS Pinza muscular	202
Tijeras finas	91-105,100,102,104-107,111,119-124	Tubos de aspiración	537-539,577-578
Tijeras finas para anatomía	93	Tubos de aspiración para CIRUGIA BARIATRICA	577-578
Tijeras finas para cirugía	93	TUEBINGEN Micro Ganchitos	303
Tijeras finas para disección	104-106	TUEBINGEN Pinzas para suturas	198
Tijeras finas para estrabismo	92	TUEBINGEN Separador	347
Tijeras nasales	119,120	TUEBINGEN Separador autostático	410
Tijeras oculares	67-75	TUFFIER Espátula abdominal	355
Tijeras oculares "Ribbon type"	66	TUFFIER Pinza intestinal y para tejidos	243
Tijeras para amigdales	122	TURNBULL Pinzas corta-uñas	28
Tijeras para arteria coronar	81	TURNER-WARWICK Separador abdominal	426-428
Tijeras para bocio	123		
Tijeras para cartilago	123	U	
Tijeras para cirugía	97,125	UCKERMANN Porta-algodones	529
Tijeras para cirugía plastica	119-121	ULRICH Pinzas para tampones y torundas	296
Tijeras para cirugía profunda	94,96,97,125,126	UNIVERSAL Tijeras para ligaduras	117,134
Tijeras para cornea	70	UNIVERSAL Trócares	541
Tijeras para decapitación	116	UNNA Saca-comedones	31
Tijeras para disección	94,998-104,125-132	UNNA-VIDAL (GREG) Saca-comedones	31
Tijeras para disección para CIRUGIA BARIATRICA	564-565	URO Pinzas para uréter atraumaticas	268
Tijeras para el canal salivar	123	USA-MODELO Pinzas de disección	144,150
Tijeras para el tabique nasal	122	USA-MODELO Pinzas para tubos	292
Tijeras para enterotomía	112,127	US-ARMY Separadores	329
Tijeras para enucleación	69		
Tijeras para enucleación	69	V	
Tijeras para episiotomía	115	VAN ALEYA Cánula lavadora	542
Tijeras para esclerotomía	69	VANNAS Micro-Tijeras	76,77,86,88
Tijeras para estrabismo	66,67,92,124	VANNAS Tijeras para iridectomía	74
Tijeras para Ginecología	114-116,126,127	VANNAS-TÜBINGEN Tijeras para catarata	74
Tijeras para hender las uñas	33	VARADY Mini Flebextractor	544
Tijeras para incisión	95	VARADY Phlebextractores	544
Tijeras para la cirugía plastica	106,111,118,119-122	VARADY Phlebodisecadores	544
Tijeras para la vena cava	107	Varices, instrumentos-	543-544
Tijeras para ligaduras	117,134	Vasos graduados	611
Tijeras para Micro-Ginegología	78	VAUGHAN bisturi para abscesos	61
Tijeras para nervios	111	VENAE-SECTIO Estuche	512
Tijeras para Neurocirugía	111	Vendajes y yeso	556-560
Tijeras para recto	112,113,127	VERRES Agujas para biopsia	547
Tijeras para recto	112,113,127	VIDAL Rascador para lupus	31
Tijeras para tenotomía	93	VIRCHOW Cuchillos para cartilagos	60
Tijeras para vasos y fistulas	95,134	VIRTUS (RALK) Pinzas para espinas	162
Tijeras para vendajes y yeso	135-137	WISE Micro-Pinzas para suturas	160
Tijeras para vitrectomía	75	VITRECTOMIA- Tijeras	75
Tijeras para ZURDOS	91,92,98,101,120,135	VOLKMANN Ganchos para huesos	335
Tijeras pituitarias	90	VOLKMANN Separadores con dientes	332,333,335
Tijeras PROMEDUR	124-134,135	VOLLMAR Strippers para várices	543
Tijeras SUPERCUT	67,91-93,95,97-105,108,114,,116,118,120,121		
Tijeras umbilicales	116,116	W	
Tijeras universal para venjajes y tela	136	WACHENFELDT Pinza aproximadora	506
Tijeras vasculares	107,108-110,133	WACHENFELDT Pinza para poner grapas	506
Tijeras-Micro	76-78,84-89	WAGENER Ganchitos auriculares	305
Tijeras-Micro coronarias	79-81,87	WAGNER Tijeras finas de disección	105
Tijeras-Micro para venas	83,88	WALDMANN Tijeras para episiotomía	116
Tijeras-Micro TITANIUM	80,84	WALKER Tijeras finas	92
Tiras de protección	605	WALTON Cizallas para encayolas	138
TOENNIS Gancho para dura-madre	311	WALTON Pinza para romer yeso	557
TOENNIS Pinzas hemostáticas	231	WALTON Pinzas para tampones y torundas	295
TOENNIS Portas-agujas	492		

WALTON Separadores autostáticos	398
WALTON Sierras para abrir anillos	34
WALTON-Select Sierra para anillos	34
WANGENSTEEN Pinzas de disección PROMEDUR	164
WANGENSTEEN Pinzas para coger del pulmón	154
WANGENSTEEN Portas-agujas	494,504
WARTENBERG Rueda neurologica	17
WASSMUND Separador	336
WATSON Dermatomo	63
WAUGH Pinzas de disección	146,155
WEBER Estesiómetro	22
WEBSTER Portas-agujas	488,501
WECKER Tijeras para iridectomia	71
WEISS Blefarostato	388
WEITLANER Separadores autostáticos	393
WEITLANER-BABY Separador	393
WERTHEIM Pinzas-Clamps para histerectomia	270,272,274
WERTHEIM Tijeras uterinas	100
WERTHEIM-ATRAUMA Pinzas-Clamps para histerectomia	273
WERTHEIM-CULLEN Pinzas-Clamps para histerectomia	273
WERTHEIM-DEBAKEY Pinzas-Clamps para histerectomia	275
WESTCOTT Tijeras oculares	71
WESTERMAN (Jensen) Agujas para biopsia	546
WHITE Pinzas para amígdalas	237
WICKHAM Clamps Bulldog atraumaticas	215
WICKHAM Pinza para poner Clamps Bulldog	215
WIEN Porta ligadura	517
WIENER Ganchos para iris	302
WIGMORE Sierra para yeso	556
WIJNEN Tubo de aspiración	538,578
WIJNEN Tubo de aspiración para CIRUGIA BARIATRICA	578
WIKSTROEM Pinzas de disección y ligaduras	235
WILDE Pinzas auriculares	189
WILDER Dilatadores para canal lacrimonasal	521
WILLET Pinza para pericráneo	284
WILLIAMS Blefarostatos	389
WILLIAMS Pinza intestinal	245
WILMER Tijeras oculares	68
WINTER Pinzas para aborto y placenta	287
WISCONSIN-FOREGGER Laringoscopios	41
WOLFF Pinzas para romper yeso	557
WORST Estilete trabecular	521
WULLSTEIN Cánulas de aspiración	534
WULLSTEIN Micro Cánulas de aspiración	532
WULLSTEIN Separadores autostáticos	398

Y

YANKAUER Tubo de aspiración para CIRUGIA BARIATRICA	
537,577	
YANKAUER Tubos de aspiración	537,577
YASARGIL Micro-Pinzas	187
YASARGIL Micro-Tijeras	88
YASARGIL Pinzas para tumores	179
YOUNG Pinza para coger prostata	269
YOUNG Pinza tira-lengua	36

Z

8-20

ZENKER Pinzas hemostáticas	230
ZENKER Separadores	353
ZIEGLER Blefarostato	389
ZIEGLER Espejo frontal	20
ZOELLNER Cánulas de aspiración	534

Indice

Pagina

Pagina

A

AACHEN Spatole cerebrali	459
ABRAMS Ago per la puntura della pleura	546
Accessori	608-612
ADAIR Pinza per il collo dell'utero	277
ADAMS Bisturi delicati	58
ADLERKREUTZ Pinze chirurgiche	153
ADSON Divaricatori autostatici	394,404
ADSON Pinza per neurochirurgia	175
ADSON Pinze anatomiche	142,143
ADSON Pinze anatomiche PROMEDUR	164
ADSON Pinze chirurgiche	148
ADSON Pinze emostatiche	225
ADSON Pinze per ipofisi	175
ADSON Portaghi	503
ADSON Tubi aspirazione	531
ADSON Uncini per nervi	309
ADSON-BABY Divaricatori autostatici	400
ADSON-BABY Pinze emostatiche	225
ADSON-BROWN Pinza chirurgiche PROMEDUR	166
ADSON-BROWN Pinze chirurgiche	153
ADSON-DEBAKEY Pinze anatomiche	142
ADSON-DEBAKEY Pinze chirurgiche	149
ADSON-GRAEFE Pinze chirurgiche	149
ADSON-MICRO Pinze anatomiche	142
ADSON-MICRO Pinze chirurgiche	148
ADSON-SELECT MICRO Pinze chirurgiche	148
AEBLI Forbici corneali	67
AEBLI Forbici per iridectomia	74
Aghi conduttori per drenaggio	540
Aghi per autopsia	588
Aghi per legatura	513-515
Aghi REVERDIN	513
Aghi-puntura ventricolare	531
Agi per eparina	547
Agi per setto nasale	549
Agi per tonsille	549
AGRICOLA Blefarostato	390
ALABAMA Pinza per strabismo	203
ALAN-PARKS Divaricatore rettale	462
Algesimetri	17
Allarge-gesso	557
ALLEN Pinze emostatiche	243
ALLIS Pinza per intestino per CHIRURGIA BARIATRICA	572
ALLIS Pinze da presa per intestino e tessuti	243
ALLIS-ADAIR Pinze da presa per intestino e tessuti	244
ALLIS-BABY Pinze da presa per intestino e tessuti	243
ALLISON Spatole per polmone	363
ALLPORT Divaricatore autostatico	392
ALLPORT Uncino auricolare	305
ALM Divaricatori autostatici	391,392
ALY Algesimetro	17
ANDERSON-ADSON Divaricatori autostatici	395
Anestesia	36-46
Angiotripi	261
ANVIL Pinza per fendere unghie	33
ARKANSAS pietra per affilare	61
ARRUGA Blefarostati	388
ARRUGA Pinze capsulari	201
ARRUGA Portaghi PROMEDUR	471
ARRUGA Porthagi	471
Arteriotomia, Forbici	79,108
ARTHUR Pinze per schegge	162
Astucchi per aghi	608,609
AUFRANC-COBRA Leve per osse	369
AUFRICHT Divaricatori nasali	307
AUFRICHT Forbici nasali	119
AUSTIN Pinze per legature	160
AUTOFILL Siringe per irrigazione	551
Autofissator per retrattori, per supporto del cranio	455-458
Autopsia	584-588

AXENFELD Divaricatori fini

303

AYER Pinze per calazio

206

B

BABCOCK Pinze per afferare intestino e tessuti	245
BABCOCK Pinze per afferare intestino e tessuti PROMEDUR	246
BABCOCK-DEBAKEY Pinze per afferare intestino e tessuti	246
BABINSKY Martello percussore	16
BABY-ADSON Divaricatori autostatici	400
BABY-ADSON Pinze emostatiche	225
BABY-ALLIS Pinze da presa per intestino e tessuti	243
BABY-BALFOUR Divaricatore addominale	415
BABY-COLLIN Divaricatore addominale	411
BABY-CRILE Pinze emostatiche	222
BABY-GELPI Divaricatori per vagina	408
BABY-INGE Separatori per vertebre	443
BABY-KOCHER Pinze intestinali	249
BABY-LEXER Forbici fine PROMEDUR	124
BABY-LEXER Forbici per dissezione	100,124
BABY-METZENBAUM Forbici per dissezione	100
BABY-MIKULICZ Pinze per peritoneo	270
BABY-MIXTER Pinze per preparazione	235
BABY-OVERHOLT Pinza emostatiche	233
BABY-ROUX Divaricatore	330
BABY-SENN-MILLER Divaricatori	321
BABY-WEITLANER Divaricatori autostatici	393
BACKHAUS Pinze fissateli	290
BACKHAUS Pinze fissateli e per tubi	290
BADGLEY Divaricatore per laminectomia	434
BAINBRIDGE Pinze emostatiche	227
BAKES Dilatatore per coledoco	528
BALFOUR Bracci laterali	417
BALFOUR Divaricatori addominali	415-417
BALFOUR-BABY Divaricatore addominale	415
BALL e SOCKET Pinze fissateli	291
BALLENGER Pinza per tonsille	238
BALLENGER Pinze per medicazione e tamponi	293
BANDIT-LEKSELL Pinze sgorbia per CHIRURGIA BARIATRICA	580
BARON Tubi de lavago	535
BARR Divaricatore rettale	463
BARRAQUER Blefarostato	388
BARRAQUER (Colibri) Blefarostati	388
BARRAQUER Forbici per iridectomia	71,72
BARRAQUER Pinza depilatoria	163
BARRAQUER Pinze di fissazione	196
BARRAQUER Pinze per la camera anteriore	202
BARRAQUER Pinze per sutura	194,199
BARRAQUER Porthagi 13 cm	472,473
BARRAQUER-COLIBRI Pinze fissatrici	194
BARRAQUER-KATZIN Pinze per iride	194
BARRAQUER-TROUTMAN Porthagi	472
BARRET Pinza per il collo dell'utero	276
BARRON Manico per bisturi	54
BARSKY divaricatore cuteano	307
BAUER Separatori intraorali	378
BAUER Separatori intraorali con luce fredda	378
BAUMGARTNER Portaghi	501
BAUMGARTNER Portaghi PROMEDUR	488
BECKMAN-EATON Divaricatore autostatico	403
BECKMANN Divaricatore autostatico	403
BECKMANN-ADSON Divaricatori autostatici	404
BECKMANN-WEITLANER Divaricatori autostatici	402
BEEBEE Forbici para fili metallici	117
BEER Pinze depilatoria	163
BEESON Allargegesso	557
Bendaggi	556-560
BENGOLEA Pinze emostatiche	226
BERENS Pinza muscolar	205
BERGH Pinze depilatoria	163
BERGMANN Divaricatore	315
BERGMANN Forbici per vendaggi	136
BERGMANN Segha per gesso	556
BERGMANN-FOERSTER Pinze per medicazione e tamponi	293
BERKE Pinze muscolari	205

	Pagina		Pagina
BERLINER Martelli percussore	16	Cannula irrigatrice per naso	535
BERNHARD Pinza fissateli	291	Cannula laringera	549
BERRY-STERNAL Portaghi PROMEDUR	492	Cannule de aspirazione	532
BERTILLON Cefalometro	23	Cannule per aspirazione	530
BEST Pinze intestinali	253	Cannule per biopsia	546
Bicchieri e cucchiai per medicinali	611	Cannule per insufflazione	547
BIEMER Forbici per vene	83,88	Cannule per irrigazione vascolar	536
Biopsia, cannule	546	Cannule per irrigazione vascolare	536
BIRKETT Pinza per tonsille	238	Cannule per puntura	545
BISHOP-HARMAN Pinze per iride	192	Cannule per vene con oliva	547
Bisturi per ascelli	61	CANNY-RYALL Divaricatori	329
Bisturi per fistole	58	CAPLAN Forbici per il setto nasale	122
Bisturi per operazione	57-58	CARMALT Pinze per scheggie	161
BLAKE Pinze per calcoli biliari	264	CARREL Pinza emostatiche	220
BLANK Pinze anatomiche	144	CARROL Goniometro	22
BLASCOVICS Pinze muscolari	205	Cassetta de selezione tharghette	602
Blefarostati	388-390	CASPAR Contra-divaricatori completo	449-453
Blefarostato per bambini	388	CASPAR Distrattori vertebrali	451-452
BLESSING Forbici per chirurgia PROMEDUR	127	CASPAR Divaricatore	340
BLOHMKE Pinza per tonsille	238	CASPAR Divaricatore opposto	447
BLOUNT Divaricatore per ginocchio	370	CASPAR Divaricatore per colonna lombo vertebrale	446
BOETTCHEM Forbici per tonsile	122	CASPAR Divaricatori per colonna cervicale	447,448
BONACCOLTO Pinza per sutura	200	CASPAR Divaricatori per colonna vertebrale	445
BONACCOLTO Pinze per strabismo	203	CASPAR Divaricatori per microdissectomia lombare	450
BONN Forbici per iridectomia	67	CASPAR giravite	453
BONN Forbici per strabismo	67	CASPAR Pinza per cambiare valve	448
BONN Micro-Uncino	303	CASPAR Speculi	449
BONN Pinza per sutura	198	CASPAR Speculi per ipofisectomia	450
BONN Pinze per iride	193	CASPAR trepano	453
BONNEY Pinza chirurgiche PROMEDUR	166	CASPAR Vite per distrazione	453
BONNEY Pinze anatomiche	145	CASTROVIEJO Blefarostato	389
BONNEY Pinze chirurgiche	153	CASTROVIEJO Compassi	23
BOROWSKI Divaricatori per atrio	382	CASTROVIEJO Forbici corneali	72
BOSE Divaricatore tracheale	391	CASTROVIEJO Forbici per iridectomia	72,74
BOWMAN Blefarostato	388	CASTROVIEJO Pinza capsulari	201
BOWMAN Forbici vascolar	107	CASTROVIEJO Pinze di fissazione	197,198
BOWMAN Sonde esploratrici per canale lacrimale	520	CASTROVIEJO Pinze per lamettes da rasoio	64
BOYNTON Porthagi	470	CASTROVIEJO Pinze per sutura	198
BOYS-ALLIS Pinze da presa per intestino e tessuti	244	CASTROVIEJO Portaghi	470
BOZEMANN Forbici per ginecologia	115	CASTROVIEJO Portaghi PROMEDUR	470
BOZEMANN Pinze per tamponi e spugne	297	CASTROVIEJO sonda esploratrici per canale lacrimale	521
BOZEMANN Portaghi	503	CASTROVIEJO-MICRO Porthagi	473
BOZEMANN Portaghi PROMEDUR	493	CATLIN Coltelli per amputazione	59
BOZEMANN-DOUGLAS Pinza per tamponi	297	Cavi-bipolar per pinze bipolari	172
BRAUN Pinza per il collo dell'utero	276	Cefalometro	23
BRAUN-STADLER Forbici per episiotomia	115	Cestelli per Endoscopia	600
BRIDGE Pinze emostatiche	227	Cestelli per sterilizzazione	593,595,597,599,600,601
BROM Divaricatori per veni	315	Cestelli per strumenti	612
BROMPTON Pinza per drenaggio	292	Cestelli rotondi per sterilizzazione	607
BROPHY Forbici delicate per dissezione	121	Cestello con coperchio	599
BROPHY Pinze anatomiche	144	CHAPUT Pinza emostatiche	243
BROPHY Pinze chirurgiche	151	CHARNLEY Divaricatore	429
BROWN Pinze chirurgiche	154	CHARNLEY Divaricatore orizzontale	401
BRUNETTI scalpelli per autopsia	587	CHEATLE Pinza per sterilizzazione	298
BRUNNER Aghi per legatura	515	CHERON Pinza per tamponi	297
BRUNNER Divaricatori	351,352	CHILDE Pinza pinze con porta graffe	506
BRUNNER Pinza intestinali	253	CLAR Specchi frontali	20
BRUNNER Sonde condutricci	517	CLARKE Blefarostato	388
BRUNNER-FERROZELL Sonde condutricci	517	CLOWARD Divaricatori per colonna cervicale	430,431
BRUNS Forbici per gesso	138	CLOWARD Separatori per vertebre	443
BRUNS Forbici per gesso PROMEDUR	138	CLOWARD Uncini per la dura-madre	311
BRYANT Pinza per tamponi e spugne	295	CLOWARD Uncini per nervi	309
BUCK Forbici per legature	117	CLOWARD-CONTOUR Divaricatori autostatici	400
BUCK Martello percussore	16	COAKLEY Trequarto	542
BUECHS Divaricatore per guancia	375	COBBETT Dermatomo a mano	63
BUIE Pinza a pressione	261	COHAN Porthagi	472
BUIE Sonda per fistole	526	COHAN-VANNAS Forbici per iridectomia	74
BULLDOG Clips per arteria e vena TITANIO	216	COHEN Pinza cuticular	29
BUMM Pinza per polipi uterini	286	COLLER-CRILE Pinza emostatiche per CHIRURGIA BARIATRICA	567
BUNT fermagli per strumenti	299	COLLER-CRILE Pinze emostatiche	224
BUSCH Forbici ombelicale	116	COLLIER Pelvimetro	25
		COLLIER Portaghi	501
		COLLIN Dinamometro	22
		COLLIN Divaricatori	329
		COLLIN Divaricatori addominali	411
C			
Calibri	24		
Calibro para Neurochirurgia	24		

COLLIN Manici per bisturi	53,55
COLLIN Pelvimetro	25
COLLIN Pinza per graffe	507
COLLIN Pinza per polipi	297
COLLIN Pinza tiralengua	36
COLLIN Pinze per afferrare intestino e tessuti	247
COLLIN Pinze per afferrare l'utero	282
COLLIN-BABY Divaricatore addominale	411
COLLIN-DUVAL Pinze per intestini	156
COLLIN-HARTMANN Divaricatore	330
COLLIN-LOCKTITE Divaricatori addominali	412
Coltelli per amputazione, resezione	59-60
Coltelli per gesso	556
Coltelli per il cervello	60
Coltello per periostio	60
COLVER Pinze per tonsille	238
Compassi	23
Compressorio	32
CONE Divaricatori autostatici per emilaminectomia	397
Container Mini	598
Container per Endoscopia	600
Container per sterilizzazione	592,594,594,598,600,601,607
Container per strumenti dentali	601
Container piatti	598
Contenitori per strumenti per microchirurgia	607
CONVERSE Divaricatore nasale	308
CONVERSE-ALAR Divaricatore nasale	308
COOK Blefarostati	390
COOLEY Divaricatori per atrio	383
COOLEY Pinze vascolari	158
COOLEY Tubi per aspirazione	539
COOLEY Tubi per aspirazione per CHIRURGIA BARIATRICA	539,578
COOPER Ago per legature	515
COPE Divaricatore	322
CORN Pinza per sutura	507
COTTLE (Millard) Divaricatore nasale	308
COTTLE Divaricatori nasali	307
COTTLE Divaricatori nasali	306,307
COTTLE Pinza per comunella	190
COTTLE Pinza per tessuto	190
COTTLE-ALAR Divaricatore nasale	308
COTTLE-BULLDOG Forbici nasali	118
COTTLE-DORSAL Forbici nasali	118
COTTLE-MASING Forbici nasali	119
COUPLAND Tubi per aspirazione	537
COX Divaricatore per dita e piede	393
CRAFOORD Forbici per lobectomia	107
CRAFOORD Pinze emostatiche	229
CRAFOORD-SELLORS Pinza emostatiche per CHIRURGIA BARIATRICA	569
CRAFOORD-SELLORS Pinze emostatiche	229,569
CRAWFORD Divaricatori per aorta	384
CRILE Pinze emostatiche	222
CRILE Portaghi	502
CRILE Uncini per nervi	309
CRILE-BABY Pinze emostatiche	222
CRILE-COLLER Pinze emostatiche	224
CRILE-MURRAY Portaghi	502
CRILE-RANKIN Pinze emostatiche	224
CRILE-WOOD Portaghi	502
CRILE-WOOD Portaghi per mano sinistra PROMEDUR	489
CRILE-WOOD Portaghi PROMEDUR	489
CRITCHETT Blefarostato	388
Curette per ossa per CHIRURGIA BARIATRICA	579
CUSHING Divaricatore per CHIRURGIA BARIATRICA	574
CUSHING Divaricatori	324
CUSHING Divaricatori per nervi	326
CUSHING Gancio per decompressione	314
CUSHING Pinze anatomiche	145
CUSHING Pinze anatomiche PROMEDUR	164
CUSHING Spatole cerebrali	460
CUSHING Uncini per la dura-madre	311
CUSHING Uncini per nervi	310
Cutello per falangi	59
CZERNY Divaricatore	331
CZERNY Pinza per il collo dell'utero	276

D

DALE Pinza sgorbia per CHIRURGIA BARIATRICA	580
DANDY Forbici per dura madre	111
DANDY Pinze emostatiche	223
DANDY Uncini per nervi	310
DANDY-MOSQUITO Pinza emostatica	223
DARLING Divaricatori autostatici	407
DARTIGUES Pinza afferrare il rene e utero	283
DASTOOR Pinze per strabismo	203
DAVIDSON Divaricatore per scapola	364
DAVIS Pinze per sterilizzazione	298
DAVIS Spatole cerebrali	459
DAY Uncini auricolari	305
DEAN Forbici per gengiva PROMEDUR	134
DEAN Forbici per tonsile	122
DEAVER Divaricatore e spatole per polmone	357-359
DEAVER Forbici per chirurgia	94
DEAVER Spatola per CHIRURGIA BARIATRICA	574
DEBAKEY Clamps Bulldog	218
DEBAKEY Forbici vascolari	104
DEBAKEY Forbici vascolari	109
DEBAKEY Forbici vascolari PROMEDUR	133
DEBAKEY Micro-Pinze vascolari	185
DEBAKEY Micro-Pinze vascolari TITANIO	185
DEBAKEY Pinza vascolari	157-158
DEBAKEY Pinza vascolari per CHIRURGIA BARIATRICA	567
DEBAKEY Pinze Bulldog	217
DEBAKEY Pinze chirurgiche PROMEDUR	165
DEBAKEY Pinze per tessuti e organi	248
DEBAKEY Portaghi PROMEDUR	489,490
DEBAKEY Portaghi PROMEDUR per CHIRURGIA BARIATRICA	490,576
DEBAKEY Sonde vascolari	525
DEBAKEY Tubi per aspirazione	538
DEBAKEY-BABCOCK Pinze per afferrare intestino e tessuti	246
DEBAKEY-CAROTID Clamp Bulldog	219
DEBAKEY-DOYEN Pinze intestinali	255
DEBAKEY-FEHLAND Pinza per anastomosi rettali	257
DEBAKEY-FEMUR Divaricatori autostatici	407
DEBAKEY-GERALD Pinze anatomiche	145
DEBAKEY-HAYES Pinze per anastomosi rettali	257
DEBAKEY-HEPARIN Aghi per eparina	547
DEBAKEY-KOCHER Pinze intestinali	256
DEBAKEY-MICRO Pinze Bulldog	217
DEBAKEY-SATINSKY Clamps Bulldog	219
DEBAKEY-SCUDDER Pinze intestinali	259
DEBAKEY-SELECT Portaghi DIAMANTE	491
DEBAKEY-WERTHEIM Pinze per isterectomia	275
DECHAMPS Aghi per legatura	514
DEJERINE Martelli percussore	16
DEMARTELL Forbici vascolari	110
DENIS-BROWN Divaricatori addominali	418
DENIS-BROWN Pinza per afferrare tessuti	156
Dental Container	601
DENTAL Siringe per cartuccia	552
DERF Portaghi	501
DERF Portaghi PROMEDUR	488
Dermatologia	31-34
Dermatomi	62-63
DERMOT PIERSE Pinze di fissazione	195
D'ERRICO Divaricatore per le radici dei nervi	314
DESJARDINS Pinze per calcoli biliari	264
DESJARDINS Pinze per condotto biliare	262
DESJARDINS Sonde per calcoli biliari	527
DESMARRES Elevatori per palpebre	304
DESMARRES Pinze per calazio	206
Diagnostica	8-20
DICK Pinze per pressione	271
DIEFFENBACH Clips Bulldog	210
DIETRICH Portaghi PROMEDUR	500
DIETRICH Pinze Bulldog	214
Dilatatore per coledoco	528
Dilatatori lacrimali	520-521
Dilatatori per condotti biliari	527-528
Dilatatori vascolari	525
Dinamometro	17,22

	Pagina		Pagina
DINGMAN Divaricatori per zigoma	381	E	
Dissetore a aspirazione	535,536	EICKEN-KILLIAN Tubi de lavago	535
Distributore di cotone	608	EISELSBERG Forbici per legature	117
Distributore di filtri	603	ELSCHNIG Pinza capsulari	201
Distributore per spazzole	30	ELSCHNIG Pinze di fissazione	196
Divaricatore a forma di sella	324-326	EMMET Pinza per tamponi e spugne	296
Divaricatore autostatico per il cuoio capelluto	399,400	EMMET Uncini per fistole	327
Divaricatore orizzontale	401	Endospecoli	466
Divaricatore per chirurgia maxillo-facciale	371-381	ENGEL Sega per gesso	556
Divaricatore per dita e piede	393	EPICARDIAL Divaricatori autostatici TITANIO	392
Divaricatore per femur	407	ERHARDT Pinza palpebrale	204
Divaricatore per ginocchio	370	ESMARCH Coltello per gesso	556
Divaricatore per guance	373	ESMARCH Forbici per vendaggi	136
Divaricatore per I.M.A.	461	EWALD Pinze anatomiche	142
Divaricatore per la tiroide	343	EWALD Pinze chirurgiche	148
Divaricatore per osse	368	EXACTA Manometro	9
Divaricatore per tessuti molli	371-372	EXTRA ORAL Separatori	380
Divaricatore per tiroide e vagina	407	EXTRA ORAL Separatori con luce fredda	380
Divaricatore per zigoma	373		
Divaricatore tracheale	391	F	
Divaricatore vaginali	362	FAHLBUSCH Micro-Forbici	90
Divaricatore vascolari	409	FARABEUF Divaricatori	328
Divaricatori	302-384	FARRELL Portecotone	529
Divaricatori "Sculpo"	367	FAURE Pinze per peritoneo	270
Divaricatori addominali	411-429,439-440	FAVALORO Forbici vascolari	109
Divaricatori autostatici	387-464	FEHLAND Pinza intestinale	253
Divaricatori autostatici per emilaminectomia	396	FEHLAND-DEBAKEY Pinza per anastomosi rettali	257
Divaricatori delicate con denti	319	FEILCHENFELD Pinze per scheggie	161
Divaricatori doppi	328-332	FELDHEIM Compressirio per dita	32
Divaricatori fini	317-320	FERGUSON Forbici per Ginecologia	115
Divaricatori fini, doppi	321-323	FERGUSON Pinza a pressione	261
Divaricatori per atrio e aorta	382-384	Fermafiltro per Container	603
Divaricatori per CHIRURGIA BARIATRICA	574-575	Fermagli per strumenti	299
Divaricatori per colonna cervicale	430-433	FERRIS-SMITH Pinze chirurgiche	151
Divaricatori per colonna lombo vertebrale	446	FERROZELL Sonda conduttrici	517
Divaricatori per colonna vertebrale	447-449	Filtri, carta	603
Divaricatori per el timo	322	Filtri, tessile	604
Divaricatori per ginocchio	370	FINK Uncino	302
Divaricatori per guance	373	FINOCCHIETTO Pinza per bronchi	239
Divaricatori per il cervelletto	395-397	FINOCCHIETTO Portaghi	503
Divaricatori per la micro dissectomia lombare	450-453	FINOCCHIETTO Portaghi PROMEDUR	493
Divaricatori per laminectomia	434-437	FINSEN Divaricatori autostatici	391
Divaricatori per pelle	31,315	FISCH Tubi aspirazione	531
Divaricatori per vulva	407-409	FISH Sonda auricolari	524
Divaricatori per zigoma	381	FISHER-ARLT Pinza per oftalmologia	191
Divaricatori rettali	463-464	FLAGG Pinze per medicazione	174
Divaricatori spinali	309,362	FLETCHER Pinze per medicazione e tamponi	294
Divaricatori vesicale	465-466	FOERSTER Divaricatore addominale, radiotrasparente	425
Divisori per ceste	606	FOERSTER Pinza-tamponi per CHIRURGIA BARIATRICA	573
Divisori per Container	593,595,597	FOERSTER Pinze per iride	192
DOCKHORN Divaricatori per guancia	373	FOERSTER Pinze per medicazione e tamponi	293,294,573
DOUGLAS Pinze depilatoria	163	FOMON Forbici nasali	118
DOUGLAS Trequearto per puntura del seno mascellare	542	FOMON Uncini per le pinne nasali	307
DOYEN Divaricatore	345	FOMON-DORSAL Forbici nasali	118
DOYEN Forbici per Ginecologia	115	Forbici	66-137
DOYEN Pinza fissateli	290	Forbici corneali	70-74
DOYEN Pinza per polipi	265	Forbici coronari	80
DOYEN Pinza per polipi uternini	285	Forbici delicati per dissezione	67-69,91-99,100,104-107,119,121,124,128
DOYEN Pinze intestinali	249	Forbici micro	76-89
DOYEN Portaghi	501	Forbici micro per vene	83,88
DOYEN Sonda canellate	523	Forbici nasali	118-122
DOYEN Valve addominale	424	Forbici oculari	66-75,91-93,124
DOYEN-DEBAKEY Pinze intestinali	255	Forbici oculari delicate	68
DOYEN-STILLE Divaricatori	345	Forbici ombelicali	115,116
DUBOIS Forbici per decapitazione	116	Forbici per arteria coronaria	79-81,87,109
DUEHRSEN Pinze anatomiche	145	Forbici per cartilagini	123
DUEHRSEN Pinze chirurgiche	152	Forbici per chirurgia	94,96-97,125
DUNHILL Pinze emostatiche	222	Forbici per CHIRURGIA BARIATRICA	564-565
DUPLAY Pinza per il collo dell'utero	278	Forbici per chirurgia plastica	104-106,119-121,124
DUPLAY Pinze per medicazione	296	Forbici per chirurgia PROMEDUR	125
DUPLEX Stetoscopi	18	Forbici per condotto saliva	123
DURANTE Pinze chirurgiche	155	Forbici per decapitazione	116
DUVAL Pinza per afferrare tessuti	156	Forbici per dissezione	94-95,98-104,113-114,125-132,
DUVAL Pinze per afferrare intestino e tessuti	247	Forbici per dura-madre	111
DUVAL Pinze per afferrare intestino e tessuti PROMEDUR	247		

	Pagina		Pagina
Forbici per enterotomia	112	GLOVER Pinze Bulldog	212
Forbici per enucleazione	69	GOELET Divaricatore doppio	331
Forbici per episiotomia	115	GOLDMAN-FOX Forbici per gengiva	105,124
Forbici per fistole	95,106,134	GOLDMAN-FOX Forbici per gengiva PROMEDUR	124
Forbici per gengiva	105,124	GOLDSTEIN Blefarostato	390
Forbici per ginecologia	115,116,126-127	GOLDSTEIN-MINI Blefarostato	390
Forbici per il retto	112,113,127	GOOD Forbici per tonsile	122
Forbici per incisione	95	GORNEY Dissetore a aspirazione	536
Forbici per ipofisectomia	90	GORNEY Forbici per dissezione	106
Forbici per la cuticola	28	GORNEY Forbici per il setto nasale	122
Forbici per la MANO SINISTRA	91,92,98,101,120,135	GOSSET Divaricatori addominali	414
Forbici per legature	117,134	GRADLE Forbici per legature	117
Forbici per legature PROMEDUR	134	GRAEFE Blefarostati	388
Forbici per nervi	111	GRAEFE Forbici oculari	68
Forbici per nervi trigemino	111	GRAEFE Micro-Uncini	302,303
Forbici per neurochirurgia	111	GRAEFE Pinze chirurgiche	147
Forbici per parametrio	99	GRAEFE Pinze di fissazione	196
Forbici per sclerotomia	69	GRAEFE Pinze per dissezione	140
Forbici per strabismo	66,67,92,93,124	GRAEFE Pinze per iride	191
Forbici per tendini e legature	71	GRAEFE Uncinetti per strabismo	304
Forbici per tenotomia	93	GRAEFE-SELECT Pinze chirurgiche	147
Forbici per tonsile	122	GRAEFE-SELECT Pinze per iridectomia	140
Forbici per unghie	28	GRAHAM Uncino per nervi	309
Forbici per vena cava	107	GRAY Pinze pe condotto biliare	263
Forbici per vendaggi a gesso	135-137	GRAZIL Forbici per chirurgia	96
Forbici per vitrectomia	75	GREEN Divaricatore per la tiroide	343
Forbici PROMEDUR	124-135	GREEN Pinze di fissazione	196
Forbici SUPERCUT	91-93,95,97-105,108,114,115,118,120,121	GREEN Uncinetto per strabismo	304
Forbici TITANIO	80,84	GREEN-ARMYTAGE Pinze serra-utero	284
Forbici vascolari	107,108-110,133	GREGORY Pinze Bulldog	213
FORCHETTA da sutura	517	GREGORY Portaghi	482
FOSTER-GILLIES Portaghi PROMEDUR	497	GROSS Pinze per medicazione	296
FOX Curete per lupus	32	GRUENWALD (Jansen) Pinze nasali	190
FRANKLIN-SILVERMAN Cannule per biopsia	546	Guancio per mento	377
FRAZIER Aghi-puntura ventricolare	531	GUILDORD Forbici per fili metallici nero	117
FRAZIER Cannula de aspirazione	533	GUILLEN Raspatorio con aspiratore	535
FRAZIER Cannula de aspirazione isolare	533	GUNNAR-HEY Pinza per drenaggio	292
FRAZIER Uncini per la dura-madre	311	GUTHRIE Uncinetti doppio	302
FREER Uncino per mucosa	306	GUYON Pinza renali per CHIRURGIA BARIATRICA	571
FRITSCH Divaricatori	347	GUYON Pinze renali	266
FUCHS Pinza capsulari	201		
FUCHSIG Pinza emostatiche	226	H	
FUKUSHIMA Tubi aspirazione malleabile	530	HABERER Spatole abdomenali	355
		HALSEY Portaghi	501
G		HALSEY Portaghi PROMEDUR	488
Ganci per cripta	526	HALSEY Portaghi per mano sinistra	488
Ganci per ossa	335	HALSEY-MICRO Portaghi PROMEDUR	488
Gancio per decompressione	314	HALSTED Pinze emostatiche	225
GARRETT Sonde vascolari	525	HARMS Sonde trabecolari	521
GAUSS Pinza per il cuoio cappelluto	284	HARRINGTON Divaricatori/spatole per polmone	361
GELPI Divaricatori per vagina	408	HARRINGTON Pinza per bronchi	239
GELPI-BABY Divaricatori per vagina	408	HARRINGTON Pinza per bronchi per CHIRURGIA BARIATRICA	572
GELPI-MINI Divaricatori per vagina	408	HARRISON Pinza per la sterilizzazione	298
GELPI-ORTHO Divaricatore autostatico	409	HARTMANN Cannule de lavago	535
GELPI-SELETZ Divaricatore autostatico	409	HARTMANN Pinze emostatiche	220
GEMINI Pinza emostatica per CHIRURGIA BARIATRICA	571	HARTMANN Pinze per legature	220
GEMINI Pinze per preparazione	234	HARTMANN-MICRO Pinze emostatiche	220
GEMINI-MINI Pinze per preparazione	234	HARVEY Forbici para fili metallici	117
GERALD Pinza chirurgiche PROMEDUR	165	HARVEY-JACKSON Divaricatore autostatico	405
GERALD Pinze anatomiche	145	HAYES-DEBAKEY Pinze per anastomosi retтали	257
GERALD Pinze chirurgiche	151	HEANEY (Hegar) Portaghi	504
Gessi	556-560	HEANEY Divaricatori vaginali	362
GEUDEL-NEGUS laringoscopii	42	HEANEY Pinze per isterectomia	272
GILL Pinze per iride	193	HEANEY Portaghi PROMEDUR	494
GILL-HESS Pinze per iride	193	HEANEY-KANTER Pinze per isterectomia	272
GILLIES Divaricatori per pelle	315	HEANEY-REZAK Pinze per isterectomia	272
GILLIES Pinza chirurgica PROMEDUR	165	HEATH (Hunt) Pinza per calazio	207
GILLIES Pinza chirurgica PROMEDUR	149	HEGEMANN Forbici vascolari	108
GILLIES Portaghi con forbici	505	HEGENBARTH Pinza per applicare graffe	506
GILLIES Portaghi con forbici PROMEDUR	498	HEIFETZ MICRO-Pinza con anello	187
GILLIES Uncini cutane	31,315	HEIFETZ Pinze per tumori	179
GILLIES-MINI Portaghi con forbici	505	HEIFETZ Spatole cerebrali	459
GILLIES-MINI Portaghi con forbici PROMEDUR	498	HEISS Pinze emostatiche	226
GIL-VERNET Divaricatori per veni e hilus	325	HENLEY Divaricatori autostatici	410
GLASSMANN pinze atraumatiche	159	HENNING Allargegesso	557

	Pagina		Pagina
HENROTIN Pinza per il collo dell'utero	280	JUDD-ALLIS Pinze da presa per intestino e tessuti	244
HENRY Pinze depilatoria	163	JUDD-MASON Divaricatore vescicale	464
HERMANN Allargegesso	557	JULIAN Portaghi PROMEDUR	491
HERRICK Pinza per peduncolo renale	266		
HERTZLER Divaricatore addominale	415	K	
HESS Pinze capsulari	201	KADER Spatole abdominali	354
HESS Pinze per iride	194	KALT Pinza capsulari	201
HEYMANN Forbici nasali	118	KALT Portaghi PROMEDUR	471
HEYWOOD-SMITH Pinze per polipi uterini	285	KALT Porthagi	471
HIBBS Divaricatore spinal	362	KALT-ARRUGA Portaghi	471
HIBBS Valve	438	KANTROWITZ Pinze per preparazione e legature	234
HOEN Divaricatore per colonna cervicale	432	KATSCH Tiracomodoni	31
HOEN Pinza per neurochirurgia	175	KATZIN Forbici per iridectomia	73
HOEN Uncino per nervi	309	KATZIN-BARRAQUER Forbici per iridectomia	73
HOESEL Divaricatori	346	KAYE Forbici per chirurgia plastica	120
HOESEL Portaghi PROMEDUR	497	KAYE Portaghi con forbici PROMEDUR	498,499
HOESEL-OFFSET Portaghi PROMEDUR	497	KELLY Divaricatori	344
HOLSCHER Divaricatore per nervi	313	KELLY Forbici per chirurgia	95
HOLTZHEIMER Divaricatori autostatici	392	KELLY Forbici per chirurgia PROMEDUR	134
HOLZBACH Divaricatore addominale	413	KELLY Forbici per fistole	95,134
HOPKINS Coltello per gesso	556	KELLY Pinza per aborto e placenta	287
HORGAN valve centrale	417	KELLY Pinze emostatiche	222,230
HOUSE Tubi aspirazione	531	KELLY-RANKIN Pinze emostatiche	224
HRYNTSCHAK Divaricatore vescicale	465	KELMAN-McPHERSON Pinza per sutura	199
HULKA Pinza per il collo dell'utero	278	KERSTING Pinza per anastomosi rettali	258
HULKA-KENWICK Pinza per il collo dell'utero	278	KEYES Trefine cutanee	32
HUMBY Dermatomo a mano	63	KILLIAN Tubo de lavago	535
HUNT Pinza per afferrare tumori	179	KILNER (Ragnell) Forbici delicate	120
HUNTER Pinze per scheggie	161	KILNER Divaricatore nasale	308
		KILNER Forbici delicate	119
I		KILNER Portaghi	501
I.M.A. Divaricatore autostatico per mamaria	461	KILNER Portaghi PROMEDUR	488
Identificazione, targhette	602	KILNER Uncini cutane	31,315
ILIC Pinza cuticular	29	KIRKLIN Divaricatori malleabili	324
INFANT Dilatatore lacrimale	521	KIRSCH Divaricatori per guancia	373
INGE Separatori per vertebre	444	KIRSCHNER Divaricatori addominali	419,420
INGE-BABY Separatori per vertebre	443	KIRSTEIN Forbici nasali	118
Insufflazione, cannule	547	KLAPP Divaricatori	320
INTRA ORAL Separatori	379	KLEINERT-KUTZ Uncini cutane	31,315
INTRA ORAL Separatori con luce fredda	379	KLIMA-ROSEGGER Cannula per puntura	545
INTRACARDIAC Portaghi PROMEDUR	492	KLINGENBERG-LOTH Forbici per dissezione	107
IOWA Pinza per rompere membrana	285	KLING-EX Togliere-lame	50
IRIS Forbici con anelli grandi	92	KLINIKUM BERLIN Pinza serratubi	292
IRIS Forbici PROMEDUR	124	KNAPP Forbici per iridectomia	67
ISRAEL Divaricatori	337	KNAPP Pinza per tracoma	204
		KNAPP Uncino	302
J		KNOWLES Forbici per vendaggi	135
JACKSON Uncini tracheali	322	KOCHER Divaricatori	334,338,341,342
JACKSON-BURROWS Divaricatore autostatico	409	KOCHER Pinze emostatiche	231,232
JACOBS Pinza per il collo dell'utero	280	KOCHER Pinze intestinali	250
JACOBSON-ADSON Micro-Pinza	176	KOCHER-BABY Pinze intestinali	249
JACOBSON-MICRO Forbici	82	KOCHER-DEBAKEY Pinze intestinali	256
JACOBSON-MICRO Pinze	176	KOCHER-FINO Pinze emostatiche	231
JACOBSON-MICRO Pinze emostatiche	221	KOCHER-WAGNER Divaricatori	347
JACOBSON-MICRO Portaghi	481	KOENIG Divaricatori	320
JAEGER Uncinetti per strabismo	304	KOENIG Forbici per fissurare unghie	33
JAMESON Calibro micrometrico	24	KOENIG Sonde condutrici	516
JAMESON Forbici fine per dissezione	104	KOERTE Divaricatori	336
JAMESON Pinze muscolari	204	KOERTE Spatola addominale	356
JAMESON-WERBER Forbici fine per dissezione	104	KOGAN Endospeculi	466
JANET Siringe	550	KONRICH cestelli rotondi per sterilizzazione	607
JANSEN Divaricatori autostatici	392	KRAUSE Trequarti	542
JAVERTS Pinze per medicazione e tamponi	294	KRONECKER Aghi per legatura	515
JEFFERSON Pinze anatomiche	143	KUEHNE Pinza con copertura vetrificata	162
JEFFERSON Pinze chirurgiche	149	KUEMMEL Spatola addominale	356
JOBSON-HORNE Portecotone	529	KÜSTNER Pinza per il collo dell'utero	281
JOHN-HOPKINS Clips Bulldog	210		
JOHN-HOPKINS Pinza per applicare clips	210	L	
JOHN-HOPKINS Pinza per condotto biliare	263	LA GRANGE Forbici per sclerotomia	69
JOHNSON Portaghi	503	LAHEY Divaricatori	337
JOLL (Friedmann) Divaricatore per tiroide e vagina	407	LAHEY Pinze per preparazione e legature	262
JONES Pinze fissateli	290	LAHEY Uncino per la dura-madre	311
JOSEPH Forbici delicate per dissezione	121	LAHEY-METZENBAUM Forbici per dissezione	101
JOSEPH Uncini delicati	306	LAMBERT Pinza per calazio	206

LAMBOTTE Elevatore per osse	368
Lame per bisturi	48-49,50,51
Lame per bisturi per anatomia	50
Lamette de rasoio	64
LANCASTER Blefarostato	389
LANDAU Trequarto	542
LANDOLD Manici bisturi	51
LANE Leve par osse	368
LANE Pinze chirurgiche	154
LANE Pinze fissateli	291
LANE Pinze gastrointestinali	254
LANE-TRETHOWAN Leve per osse	368
LANGENBECK Portaghi PROMEDUR	493
LANGENBECK Coltelli per resezione	60
LANGENBECK Coltello per amputazione	59
LANGENBECK Divaricatori	339,340
LANGENBECK-MINI Divaricatori	323
Laringoscopi	37-46
Laringoscopi di luce fredda	43-46
LATERAL Divaricatore	466
LAWRENCE Pinza per preparazione	235
LAZAR Micro-Pinza per legature	160
LEGGERO-PIUMA Pinze Bulldog	215
LEGUEU Divaricatore vesicale	412
LEMPERT Tonchesina per la cuticola	29
Lente frontali	19
LERCHE Pinza chirurgica	153
LERICHE Pinze emostatiche	223
LERICHE Spatola addominale	356
LERMOYEZ Trequarti	542
LESTER Pinze di fissazione	196
LeVASSEUR-MERRILL Separatori extraorali	381
LeVASSEUR-MERRILL Separatori extraorali con luce fredda	381
Leve per osse	368,369
LEXER Forbici per dissezione	99,126
LEXER-BABY Forbici fini per dissezione	100,124
LEXER-BABY Forbici fini PROMEDUR	124
LEYLA Divaricatore Sistema per fissare all' tabolo operatorio	455-458
LEYLA Pinza portaspecoli auricolari	456
LEYLA Portaspeculi auricolari	456
LICHTENBERG Portaghi PROMEDUR	496
LICHTWITZ Trequearti per puntura del seno mascellare	541
LIEBERMANN Blefarostati	390
Lime per unghie	30
LISTER Forbici per vendaggi	135
LISTER Forbici per vendaggi PROMEDUR	135
LISTER-EXCENTRIC Forbici per vendaggi	135
LISTER-SINUS Pinze per tamponi e spugne	295
LISTON Coltelli per amputazione	59
LISTR-BURCH Blefarostato	389
LITTAUER Forbici per legature	117
LITTAUER Pinze depilatoria	163
LITTLEWOOD Pinze da presa per intestino e tessuti	244
LLOYD-DAVIS Forbici per il retto	113
LLOYD-DAVIS Pinza per anastomosi rettali	261
LOCKHART-MUMMERY Sonde per fistole	523
LOCKLIN Forbici per gengiva	106,134
LOCKLIN Forbici per gengiva PROMEDUR	134
LOCKWOOD Pinze da presa per intestino e tessuti	245
LONDON-COLLEGE Pinze per medicazione	173
LORDAN Pinza per calazio	207
LORENZ Forbici per vendaggi	135
LORNA Pinze fissateli	291
LOVE Separatori per le radici dei nervi	312
LOVELACE Pinze emostatiche	223
LOVELACE Pinze per afferrare polmone	241
LOWER Pinza per condotto biliare	263
Lubrificazione, olio	608
LUCAE Pinze auricolari	189
LUCAE Uncini auricolari	305
Luce fredda, Laringoscopii	43-46
LUKENS Uncino per il timo	322
LURZ Pinze per uretere	269

M

MAGILL Cannule de aspirazione	536
MAGILL Pinze per intubazione	36
MAIER Pinze per medicazione	296
MALTZ Divaricatore bottonuta	307
Manici per bisturi	50-56
Manici per bisturi / anatomia	50
Manici per micro-bisturi	51
MANNERFELT Divaricatori	316-317
MANNERFELT-LANGENBECK Divaricatori	317
Manometri	8-10
MARBERGER Divaricatori malleabili	325
MARINUS Pinze intestinali	260
MARKHAM-MEYERDING Divaricatori autostatici	406
MARSCHIK Pinza per tonsille	238
MARTEL Pinza per pericraneo	284
Martelli percussori	16
Martello per autopsia	587
MARTIN Divaricatore	348
MARTIN Forbici per cartilagini	123
MARTIN Pelvimetro	25
MARTIN pinza per rifiuti	298
MASSON Portaghi	504
MASSON Portaghi PROMEDUR	494
MATHIEU Divaricatore	321,330
MATHIEU Portaghi	505
MATHIEU Portaghi PROMEDUR	496
MATHIEU Speculo rettale	462
MATHIEU-KOCHER Portaghi PROMEDUR	496
MAYO fermagli per strumenti	299
MAYO Forbici per CHIRURGIA BARIATRICA	565
MAYO Forbici per dissezione	98,125,565
MAYO Forbici per dissezione per CHIRURGIA BARIATRICA	565
MAYO-ADAMS Divaricatore addominale	412
MAYO-BLAKE Pinze per calcoli biliari	265
MAYO-GUYON Pinza renali	266
MAYO-HARRINGTON Forbici per ginecologia	99
MAYO-HARRINGTON Forbici PROMEDUR	126
MAYO-HEGAR Portaghi	490,502,577
MAYO-HEGAR Portaghi per CIRURGIA BARIATRICA	502,576,577
MAYO-HEGAR Portaghi per mano sinistra PROMEDUR	490
MAYO-HEGAR Portaghi PROMEDUR p. CHIRURGIA BARIATRICA	490,576
MAYO-NOBLE Forbici per dissezione	99
MAYO-ROBSON Pinze intestinali	251
MAYO-RUSSIAN Pinza chirurgiche	154
MAYO-STILLE Forbici per dissezione	98,125
McCOLLOUGH Pinze per strabismo	202
McGUIRE Forbici corneali	67
McINDOE Forbici per tonsile	122
McINDOE Pinza anatomiche PROMEDUR	165
McINDOE Pinze anatomiche	143
McINTOSH laringoscopi	37-38,43-44
McPHERSON Pinze per sutura	199
MEEKER Pinza per preparazione	235
MELLINGER Blefarostati	389
MELLINGER-AXENFELD Blefarostati	389
MEMORY Spatole cerebrali	460
MENGHINI Cannule per biopsia	545
MERIAM Pinze per medicazione	174
METZENBAUM Forbici "S"-curve PROMEDUR	132
METZENBAUM Forbici per CHIRURGIA BARIATRICA	564
METZENBAUM Forbici per dissezione	101,102,128-132
METZENBAUM Forbici PROMEDUR	128-132
METZENBAUM Forbici PROMEDUR per CHIRURGIA BARIATRICA	565
METZENBAUM Portaghi	503
METZENBAUM-BABY Forbici per dissezione	100
METZENBAUM-FINO Forbici "S"-curve PROMEDUR	132
METZENBAUM-FINO Forbici per dissezione	103,130,132
METZENBAUM-FINO Forbici PROMEDUR	130
METZENBAUM-LAHEY Forbici per dissezione	101
METZENBAUM-X-FINO Forbici PROMEDUR	131
MEYERDING Divaricatori	319,348
MEYERDING Divaricatori autostatici	406
MEYERDING Valve	438

	Pagina		Pagina
MEYERDING Valve	438	Necessario per infermeria	30
MEYER-SCHWICKERATH Localizzatore	302	NEGUS Pinze per tonsille	237
MICHEL Graffe	507	NEIVERT Divaricatore nasale	307
MICHEL Graffe, Set per sutura	508	NEIVERT Portaghi	502
MICHEL Pinza per applicare e togliere graffe	506	NELATON Sonda bottonuta scanalata	523
MICHEL Pinza per applicare le graffe	506	NELSON Pinze chirurgiche	153
MICRO Forbici oculari	70	NELSON Tre quarti	541
MICRO Pinze	176-188	NEW ORLEANS Portaghi PROMEDUR	491
MICRO Pinze con manico-profilo	186-188	NEWS Uncino tracheale	322
MICRO Pinze per dissezione	141	NICOLA Micro-Forbici	90
MICRO Portaghi	474-486	NISSEN Pinza emostatiche	226
MICRO-ADSON Pinze anatomiche	142	NORFOLK-NORWICH Divaricatore autostatico	397
MICRO-ADSON Pinze chirurgiche	148	NOTO Pinza per polipi uterini	286
MICRO-CASTROVIEJO Portaghi	473	NOVA-PRESAMETER Manometro	8
MICRO-Clips	210	NOYES Forbici per iridectomia	70
MICRO-Forbici	75-90	NUGENT Pinze per strabismo	203
MICRO-HALSEY portaghi PROMEDUR	488	NUSSBAUM Pinze intestinali	252
MICRO-MOSQUITO Pinze emostatiche	221		
MICRO-Pinze chirurgiche	147	O	
MICRO-Pinze con anello e manico-profilo	187	O'BRIEN Forbici per legature	117
Micro-Uncini doppi	303	OBWEGESER Divaricatori per tessuti molli	371,372
MICRO-VANNAS Forbici per iridectomia	76,77,86,88	OBWEGESER Guanchio per mento	377
MICRO-VASCOLAR Forbici	107	OBWEGESER Separatore per ramo	374
MICRO-VASCOLAR Portaghi con morsi diamantate	489	OBWEGESER Separatore per spina nasale	374
MICRO-VASCOLAR Portaghi PROMEDUR	489,491	OBWEGESER Separatori mandibolari	377
MICRO-VASCULAR-SELECT Portaghi con morsi diamantate	491	OBWEGESER Separatori per ramo	375
MIDDELDORF Divaricatori	342	OCHSNER Pinza per sutura	507
MIKULICZ Divaricatori	348	OCHSNER Trequearti	541
MIKULICZ-BABY Pinze per peritoneo	270	O'CONNOR Pinza per congiuntiva	193
MILLER Divaricatori fini	318	O'CONNOR Uncino	302
MILLER Forbici per il retto	112	OCULUS Occhiali a lenti binoculari	19
MILLER laringoscopii	39-40,45	OEHLER Pinze chirurgiche PROMEDUR	166
MILLER-BABY laringoscopii	38,40	OLDBERG Divaricatori	314
MILLESI Forbici dentate	82,88	Olio per lubrificazione	608
MILLIN Dilatatore per collo vescicale	464	OLIVECRONA Forbici per nervo trigemino	111
MILLIN Divaricatore vescicale	464	OLIVECRONA Spatole cerebrali	460
MILLS Forbici vascolari	110	OLLIER Divaricatori	336
MINI-Bulldog Clips	211	OLSEN-HEGAR Portaghi con forbici PROMEDUR	498
MINI-Clips vascolari	210-211	OLSEN-HEGAR Portaghi con forbici PROMEDUR per mano sinistra	498
MINIMUS Manometro	9	OLSEN-HEGAR Portaghi con forbici	505
MISKIMON Divaricatore autostatico	433	OLVECRONA Pinze emostatiche	229
Misuratori	22	OMBREDANNE Pinze da presa per intestino e tessuti	245
Misurini	609	ONG Forbici per iridectomia	71
MIXTER Forbici per chirurgia	95	ORL Strumenti per aspirazione e lavaggio	534-536
MIXTER Pinza per calcoli biliari	265	OSCILLOW-E.P. Seghe oscillante per gesso	558
MIXTER Pinza per condotto biliare	263	OSCILLOW-VAC Segha oscillante per gesso con aspirazione di polvo	559
MIXTER Pinze per preparazione	236	O'SULLIVAN-O'CONNOR Divaricatore addominale	422
MIXTER Sonda biliari	527	O'SULLIVAN-O'CONNOR Divaricatore addominale per CHIRURGIA	422
MIXTER-BABY Pinze per preparazione	235	BARIATRICA	575
MIXTER-O'SHAUGHNESSY Pinze emostatiche	233	OVERHOLT-BABY Pinza emostatiche	233
MOBERG Divaricatorim	320	OVERHOLT-GEISSENDOERFER Pinze emostatiche	233
MOCK Ago per eparina	547	OVERHOLT-MIXTER Pinza per preparazione e legature	233
MODULAR Divaricatori autostatici	439		
MOELTGEN Goniometro	22	P	
MOLLISON Divaricatori autostatici	398	Padelle reniformi	610
MOORFIELD Pinza per sutura	200	Panni di sterilizzazione	604
MORRIS Divaricatori	345	PARAMETRIUM Forbici PROMEDUR	127
MORRIS Divaricatori doppi	331	PARK Blefarostato	389
MORRIS-MITRAL Divaricatore autostatico vascolar	409	PARKER bisturi delicati	58
MOSQUITO Pinze emostatiche	221	PARKER Divaricatori	328
MOSQUITO-MICRO Pinze emostatiche	221	PARKER-MOTT Divaricatori	329
MOYNIHAN esploradore per calcoli biliari	527	PARK-GUYTON Blefarostato	389
MOYNIHAN Pinza fissateli	291	PARK-MAUMENEE Blefarostato	389
MOYNIHAN Pinze per condotto biliare	262	PAUFIQUE Pinze per sutura	198
MUELLER Blefarostato	389	PAYR Sonda condutricci	516
MULDOON Dilatatore lacrimale	521	PEAN Pinze emostatiche	227
MURDOCK Blefarostato	388	PEAN-FINO Pinze emostatiche	228
MURPHY Divaricatori	335	PECK-JOSEPH Forbici fine per dissezione	105
MUSEUX Pinze per il collo dell'utero	281	PEERS Pinza fissateli	290
		PEET Pinza per scheggie	162
N		PELKMANN Pinze per medicazione	295
NABATOFF Sondi per varici	543	Pelvimetri	25
NAGEL Micro-Forbici	87	PENNINGTON Pinze emostatiche	243
NASAL Forbici nasali	119	Perforatore par unghie	33
NAUNTON-MORGAN Portaghi PROMEDUR	495		

	Pagina		Pagina
Periostotomi per CHIRURGIA BARIATRICA	579	Pinze per isterectomia	272-275
PERKINS Divaricatori autostatici	399	Pinze per legature	160,241
Perno di fissaggio per divisori	606	Pinze per lingua	36
Perno di fissaggio per strumenti	606	Pinze per medicazione	173-174
PERWITZSCHKY Forbici per condotto saliva	123	Pinze per medicazione e tamponi	295-297
PHANEUF Pinze per peritoneo	271	Pinze per microchirurgia	176-188
PIERCE Trequarti	542	Pinze per microchirurgia con contrappeso	180,181,184
Pietra per affilare	61	Pinze per microchirurgia en TITANIO	180-185
PIFFARD Curete per lupus	32	Pinze per microscopia	161
PINARD Stetoscopi	18	Pinze per muscolo	204,205
Pinza apri flebo	299	Pinze per neurochirurgia	175
Pinza episcleral	197	Pinze per orologio	141
Pinza metti-rimuovi BULLDOG Clips	216	Pinze per pericraneo	284
Pinza per afferare la prostata	269	Pinze per peritoneo	270-271
Pinza per emorroidi	248	Pinze per polipi uterini	285,286
Pinza per fissare il tronco spermatico	269	Pinze per preparazione e legature	225-236
Pinza per misurare ossi	23	Pinze per pressione	261,271
Pinza per rompere membrano	285	Pinze per scheggie	161,162,163
Pinza per tamponi e spugne per CHIRURGIA BARIATRICA	573	Pinze per sterilizzazione	298,299
Pinza per tamponi e spugne per CHIRURGIA BARIATRICA	573	Pinze per sterilizzazione con recipiente e coperchio	610
Pinza per tracoma	204	Pinze per strabismo	202-203
Pinza portaspecoli auricolari	456	Pinze per sutura	198,199,507
Pinzas per la cuticola	29	Pinze per tamponi e espugne	293-294
Pinze anatomiche	144-146	Pinze per tonsile	237-238
Pinze anatomiche "USA" Mod.	144	Pinze per uretere	267,268
Pinze anatomiche con denti	147-155,,164-166,175	Pinze pressa tubi	292
Pinze anatomiche FINO	144	Pinze rome-lamette	64
Pinze anatomiche FINO PROMEDUR	164	Pinze serra-tubi	292
Pinze anatomiche per dissezione fini	140-142,147-149	Pinze serra-utero	284
Pinze anatomiche TITANIO	142-146,148-149,151,153,147-158	Pinze sgorbi per CHIRURGIA BARIATRICA	580
Pinze atraumatiche	158-159,164	Pinze-Clamps renali	266
Pinze auricolari	189	PINZE-SELECT per orologio	141
Pinze Bulldog	210-219	PLESTER Cannule de aspirazione	534
Pinze Bulldog atrumatiche	212-219	PLESTER Divaricatori autostatici	393
Pinze caplulari	200-201	PLEY Blefarostato	389
Pinze chirurgiche	147-155	POCKET-ASSISTENT Set per sutura	511
Pinze chirurgiche "USA" Mod.	150	POCKET-MINI Set per sutura	509
Pinze chirurgiche FINO	150	POCKET-MULTI Set per sutura	510
Pinze con copertura vetrificata	162	POCKET-VENAE-SECTIO Set	512
Pinze depilatoria	163	POLLOSON Divaricatore per polmone	365-366
Pinze di fillaggio per teli	605	POOLE Tubi per aspirazione	538
Pinze di fissazione	197,198	POOLE Tubi per aspirazione per CHIRURGIA BARIATRICA	538,538
Pinze emostatiche	220-236	Portacotone	529
Pinze emostatiche per CHIRURGIA BARIATRICA	567-573	Portaghi	470-504
Pinze fissateli	290-291	Portaghi PROMEDUR	470,471,,479-480,481,488-500
Pinze fissateli per copertura di carta	290,291	Portaghi con articolazione	482,495
Pinze intestinali	249260	Portaghi con forbici	497-499,505
Pinze micro- con anello	179,184,187-188	Portaghi con morsi diamantati	482,483-485,489,491,,500
Pinze microvascolari	185	Portaghi fini	470-481
Pinze nasali	190	Portaghi Micro	474-486
Pinze per afferare il reni e utero	268-269	Portaghi per CHIRURGIA BARIATRICA	576,577
Pinze per afferare tessuti e organi	243-248	Portaghi per oftalmologia	471-473
Pinze per afferare tessuti e organi PROMEDUR	246,247	Portaghi TITANIO	483-485,489
Pinze per afferare tessuti e tumori	179,187-188	Portaspecoli auricolari	456
Pinze per amnioscopia, placenta e aborto	284-287	Portetampone	529
Pinze per applicare Micro-Clips	210	POST MORTEM Aghi	588
Pinze per bronchi	239,240	POST-MORTEM Osteotomo	587
Pinze per bronchi e polmone	239-242	POTTS Forbici per dissezione	94
Pinze per calazio	204-207	POTTS-DE-MARTEL Forbici vascolari	110
Pinze per calcoli biliari	264-265	POTTS-SMITH Forbici vascolari	108
Pinze per calcoli renali	267	POTTS-SMITH Forbici vascolari PROMEDUR	133
Pinze per coagulazione bipolari	167-171	POTTS-SMITH Forbici vascolari SUPERCUT	108
Pinze per columnella	190	POTTS-SMITH Pinze anatomiche	145,146
Pinze per congiuntiva	193	POTTS-SMITH Pinze anatomiche PROMEDUR	164
Pinze per copertura vetrificata	162	POTTS-SMITH Pinze chirurgiche	152
Pinze per corpi estranei	163	POTTS-YASARGIL Micro Forbici	88
Pinze per dissezione per CHIRURGIA BARIATRICA	566-567	POZZI Pinza per il collo dell'utero	277
Pinze per dissezione PROMEDUR	164-166	PRATT Gancii a cripta	526
Pinze per estrazione e fendere unghie	33	PRATT Pinza per il collo dell'utero	280
Pinze per gesso	557	PRATT Sonde per fistole	526
Pinze per il collo dell'utero	276-281	PRATT-"T" Pinza per emorroidi	248
Pinze per il condotto biliare	262-263	PRECISA Manometro	8
Pinze per intubazione	36	Preparazione	27-30
Pinze per ipofisi	175	PRESBYTERIAN Pinze serratubi	292
pinze per iridectomia	140,141,147,191-207	PRICE-THOMAS Pinze per bronchi	240

	Pagina		Pagina
PRINCE Forbici per tonsile	122	RUSSIAN Pinze chirurgiche	154
PRINCE Pinze muscolari	205	RYDER Portaghi PROMEDUR	499
PRO-MED Divaricatore per laminectomia	442	RYDER-MINI Portaghi PROMEDUR	499
PRO-MED Portaghi modello svedese PROMEDUR	499	RYDER-MINI-SELECT Portaghi diamantate	500
PRO-MED SELECT Segha per anelli	34		
PROVIDENCE-HOSPITAL Pinze emostatiche	222	S	
Puntura, cannule	545	SAALFELD Tiracomedoni	31
Q		SACHS Uncino per nervi	310
QUINBY Forbici per gengiva	121	SAENGER Pinze per aborto e placenta	287
QUINCKE Cannule per puntura	545	SAMII Micro-Pinze con anello	188
R		SANTULLI Pinza Bulldog	214
Rachiotomo	587	SANVENERO Forbici delicate per dissezione	121
RAGNELL (Kilner) Forbici delicate PROMEDUR	124	SAROT Pinza emostatiche	230,569
RAGNELL-DAVIS Dicaricatore	321	SAROT Pinze per bronchi	239
RAMEL Ago per la puntura della pleura	546	SAROT Pinze per legature	230
RAMPLEY Pinze per medicazione e tamponi	294	SAROT Portaghi	504
RAMSAY Pinze anatomiche	145	SAROT Portaghi PROMEDUR	495
RAMSEY Pinze chirurgiche	152	SATINSKY Forbici vascolare	107
RANDALL Pinze per calcoli renali	267	SATINSKY Pinze per anastomosi	242
RANKIN-CRILE Pinze emostatiche	224	SAUER Blefarostato	388
RANKIN-KELLY Pinze emostatiche	224	SAUERBRUCH Divaricatori	349
Rasaio	61	SAUERBRUCH Pinza per rifiuti	298
Rasaio, lamette	66	SAUERBRUCH Scatola per aghi	609
Recipiente per cotone usato	608	SAWTELL Pinze per tonsille	237
Recipienti cilindrici	611	SCALP-CONTOUR Divaricatori autostatici	393
RECORD Siringe	548,549	Scalpelli per autopsia	587
REDON Agi conduttori	540	Scatoli per aghi	608,609
Reguli	22	SCHAAF Pinza per corpi estranei	163
REILL Micro Portaghi	474	SCHAEDEL Pinza fissateli	290
REINER Coltello per gesso	556	SCHAMBERG Tiracomedoni	31
RESANO Forbici per cartilagini	123	SCHIMMELBUSCH cestelli rotondi per sterilizzazione	607
RESANO Pinza per anastomosi rettali	258	SCHINK Dermatomo a mano	62
REVERDIN Aghi	513	SCHMID Cannula per irrigazione vascolar	536
REVERDIN Spatole abdominali	355	SCHMIEDEN-TAYLOR Forbici per dura madre	111
REYNOLDS Forbici fine per dissezione	104	SCHNIDT Pinze per tonsille	237
RHOTON Micro-Pinze	180-184	SCHOEMAKER Forbici per gozzo	123
RHOTON Micro-Pinze con contrappeso	180,181,184	SCHOEMAKER-LOTH Forbici per legature	117
RHOTON Micro-Pinze con punte diamantate	180-184	SCHROEDER Pinze per il collo dell'utero	277,279
RHOTON Micro-Pinze en TITANIO	180-184	SCHUKNECHT Divaricatore autostatico	399
RIBBON Forbici	66	SCHUMACHER Forbici ombelicale	116
RIBBON Forbici per strabismo	66	SCHWARTZ Clips Bulldog	211
RIBBON Forbici per suture	66	SCHWARTZ Pinza per applicare clips	211
RIBBON Spatole abdominali	355	SCHWEIGGER Pinze per sutura	200
RIBBON-IRIS Forbici	66	Scodella di Petri	609
RIBBON-KAYE Forbici oculari	66	Scodelle rotonde	610
RIBBON-STEVENS Forbici oculari	66	SCOVILLE Divaricatore per laminectomia	436
RICARD Divaricatori addominali	413	SCOVILLE Pinze-spatole	175
RICHARDSON Divaricatori	343	SCOVILLE Spatole cerebrali	459
RICHARDSON-EASTMAN Divaricatori	343	SCOVILLE Uncini per nervi	312,313
RICHTER-HEATH Pinza per graffe	507	SCOVILLE-HAVERFIELD Divaricatore per laminectomia	437
RIGBY Divaricatori autostatici	410	SCOVILLE-RICHTER Divaricatore per laminectomia	435
RITTER-HALLE Sonde per sino	524	SCUDDER Pinze intestinali	251
ROBERTS Pinze emostatiche	228	SCUDDER-DEBAKEY Pinze intestinali	259
ROBIN-MASSE Divaricatore addominale	414	SCULPO Divaricatori	367
ROCHARD Divaricatori addominali	423	Seghe oscillante per gesso	558,559
ROCHESTER-CARMALT Pinze emostatiche	227	Seghe per anelli	34
ROCHESTER-OCHSNER Pinze emostatiche	232	Seghe per autopsia	585
ROCHESTER-OCHSNER Pinze emostatiche per CHIRURGIA BARIATRICA	232,570	Seghe per gesso	556,558-560
ROCHESTER-PEAN Pinze emostatiche	228	SEGOND Pinze per isterectomia	272
ROCHESTER-PEAN Pinze emostatiche per CHIRURGIA BARIATRICA	568	SEGOND-LANDAU Pinze per isterectomia	272
ROEDER Pinze fissateli	291	SEMB Pinze per bronchi	241
ROGGE Pinza per sterilizzazione	298	SEMKEN Pinze anatomiche	143
ROLLET Uncino	302	SEMKEN Pinze anatomiche PROMEDUR	164
ROSE Uncino tracheale	322	SEMKEN Pinze chirurgiche	149
ROSEN Cannule de lavago	534	SEMM Divaricatore addominale	421
ROSS Divaricatori per aorta	384	SENN-GREEN Divaricatori	323
ROUX Divaricatori doppio	330	SENN-MILLER Divaricatori	321
ROUX-BABY Divaricatore	330	SENN-MILLER-BABY Divaricatori	321
ROUX-MINI Divaricatore	330	Separatore extraorale	380-381
RRADOLF Pinza per togliere unghie	33	Separatore interorale	378-379
RUMEL Pinze per preparazione e legature	234	Separatore mandibolare	377
RUSSIAN Pinza chirurgiche per CHIRURGIA BARIATRICA	566	Separatore per ramo	375-376
		Separatore per vertebre	442-445
		Set per autopsia	584
		Sets per diagnostica	11-15

	Pagina		Pagina
SEUTIN Forbici per gesso	138	STILLE Pinza renali	266
SEXTON Divaricatore autostatico	401	STILLE Pinze anatomiche	144
Sfigmanometri	8-10	STILLE-BARRAYA Pinze chirurgiche	155
SHEA Forbici per chirurgia plastica	120	STILLE-HAGLUND Allargegesso	557
SHEA Separatore multiuso	381	STONE Pinza chirurgiche	153
SIEBENMANN Cannule irrigatrice	536	STRABISMO Forbici PROMEDUR	124
SIEBOLD Forbici da utero	115	STRANDELL-STILLE Divaricatori	320
Sigilli di sicurezza	602	STRATTE Portaghi	504
Silicone strisce per assicurare	605	STRATTE Portaghi PROMEDUR	495
SILVER Dermatomo a mano	63	STRINGER stanghette per strumenti	299
SIMON Uncini per fistole	327	Stripper anelli	543
SIMS Forbici da utero	114	Strisce per assicurare strumenti	605
SIMS Forbici da utero PROMEDUR	126	STRULLY Forbici per dissezione	111
SIMS Forbici da utero SUPERCUT	114	Strumenti per misurare	22-25
SIMS Forbici PROMEDUR	126	Strumenti per misurare viti	24
SIMS-MAIER Pinze per medicazione	295	Strumenti per varici	543,544
SINGLEY(TUTTLE) Pinze chirurgiche	154	Supporti a molle	605
Siringhe	548-522	Sutura	470-517
Siringhe auricolari	551	SYSTRUNK Forbici per fessurare unghie	33
Siringhe de 3 anelli	549		
Siringhe per acqua	552	T	
Siringhe per cartuccia-fiala	552	Tagliacranio	587
Siringhe per irrigazione	551,552	Tapetti porta-strumenti in silicone	604
SKENE Pinza per il collo dell'utero	279	Targhette con indicatore	602
SMILLIE Divaricatori per ginocchio	370	Targhette di identificazione	602
SMITH (US-ARMY) Forbici per garza	136	TAYLOR Martello percussore	16
SMITH Blearostato	388	TAYLOR Pinze anatomiche	146
SMITH BUJE Divaricatore rettale	463	TAYLOR Pinze chirurgiche	152
SMITH Forbici per suture PROMEDUR	134	TAYLOR Uncini per nervi	309
SMITHWICK Uncini per nervi	310	TAYLOR Valve	438
SNELLEN Pinze palpebrale	204	TAYLOR-CUSHING Pinze anatomiche	146
SOFIELD Divaricatori	331	TAYLOR-CUSHING Pinze chirurgiche	152
SOMER Pinza per afferrare l'utero	282	TEALE Pinze per il collo dell'utero	281
Sonde	520-528	Telai fissateli	593,595,597,599,601
Sonde a foglia mirto	523	Telaio per sterilizzazione per micro-strumenti	606
Sonde auricolari	524	TEMPLE-FAY Divaricatore per laminectomia	436
Sonde auricolari e per sino	524	TERSON Pinza capsulari	201
Sonde bottonute	522,523,524,577	THOMS-ALLIS Pinze da presa per intestino e tessuti	244
Sonde bottonute per CHIRURGIA BARIATRICA	577	THOMSON-WALKER Divaricatore vescicale	465
Sonde bottonute scanalate	523	THOREK (HALLE) Forbici per dissezione	100
Sonde con occhiello ARGENTO	522	THOREK Forbici per dissezione	100
Sonde conduttrici	516-517	THORPE (Marchac) Calibro	24
Sonde esploratrici modello francese	520	TIEMANN Pinza per il collo dell'utero	279
Sonde per calcoli biliari	527	Tiracomedoni	31
Sonde per CHIRURGIA BARIATRICA	577	Tirevene	543
Sonde per fistole	523,524,526	TOENNIS Forbici per dissezione	104
Sonde per sino	524	TOENNIS Pinze emostatiche	231
Sonde scanalate		TOENNIS Portaghi PROMEDUR	492
Sonde trebacolari	521	TOENNIS Uncino per nervi	311
Sonde vascolari	525	TOENNIS-ADSON Forbici fini	104
Spatole addominali	354-361	TOENNIS-ADSON Forbici fini PROMEDUR	128
Spatole cerebrali	459,460	TOENNIS-RYDER Portaghi PROMEDUR	492
Spatole per polmone	363-366	Togliere-lame	50
Spazzole a mano	30	Togliere-lame	50
Specchi frontali	20	TOHOKU Pinze fissateli	291
Specilli bottonuti	522-524,526	Tonchesine per unghie	28
Specola addominale	424	Trasformatore	20
SPENCER Forbici per legature	117	TRAVERS Divaricatore autostatico	397
SPENCER-WELLS Pinze emostatiche	227	Trefine cutanee	32
St.MARKS Divaricatori per pelvis	360,463	Trequarti	541-542
St.MARTIN Pinza per sutura	198	TREVES Pinze chirurgiche	153
STACKE Sonda bottonuta	524	TROELTSCH Pinze auricolari	189
Stanghette per strumenti	299	TROELTSCH Pinze per medicature	190
STAUDE-MOORE Pinza per il collo dell'utero	276	TROEMNER Martello percussore	16
STEINHÄUSER Divaricatori per zigoma	373	TROUTMAN Forbici per iridectomia	73
STELZNER Forbici per il retto	113	TROUTMAN Pinze per iride	194
Sterilizzazione	592-607	TROUTMAN Pinze per lamettes da rasoio	64
Stetoscopi	18	TROUTMAN-RECTUS Pinza muscolari	202
STEVENS Forbici per tenotomia	93	Tubi aspirazione	535,537-539,577,578
STEVENS Pinze per iride	191	Tubi aspirazione per CHIRURGIA BARIATRICA	577,578
STEVENS Porthagi	472	TUEBINGEN Divaricatore	347
STEVENS Uncinetto per strabismo	304	TUEBINGEN Divaricatore autostatico	410
STEVENSON Blearostato	389	TUEBINGEN Micro-Uncini	303
STIEGLITZ Pinze per scheggie	162	TUEBINGEN Pinze per sutura	198
STILLE Forbici per gesso	137	TUFFIER Pinza per tessuti e organi	243

	Pagina		Pagina
TUFFIER Spatola addomendale	355	WARTENBERG Algesimetro	17
TURNBULL Tronchesine per unghie	28	WASSMUND Divaricatore	336
TURNER-WARWICK Divaricatori addominali	426	WATSON Dermatomo a mano	63
U			
UCKERMANN Portacotone	529	WAUGH Pinze anatomiche	146
ULRICH Pinze per medicazione	296	WAUGH Pinze chirurgiche	155
Uncini	302-316	WEBER Estensiometro	22
Uncini auricolari	305	WEBSTER Portaghi	501
Uncini con denti	318	WEBSTER Portaghi PROMEDUR	488
Uncini per le pinne nasali	308	WECKER Forbici per iridectomia	71
Uncini per nervi	309-314	WEISS Blefarostato	388
Uncini per oftalmologia	302-304	WEITLANER Divaricatori autostatici	393,394
Uncini per ossi	368-369	WEITLANER-BABY Divaricatori autostatici	393
Uncini per pelle e dura madre	31,307,315	WERTHEIM Forbici per ginecologia	100
Uncini per rinologia	305-308	WERTHEIM Pinze per isterectomia	272,274
Uncini per urologia e ginecologia	327	WERTHEIM Pinze per peritoneo	270
Uncini per veni	315	WERTHEIM-ATRAUMA Pinza per isterectomia	273
Uncini strabismo e per muscoli	304	WERTHEIM-CULLEN Pinza per isterectomia	273
Uncini tracheali	318	WERTHEIM-DEBAKEY Pinze per isterectomia	275
Uncini tracheali flessibile	318	WESTCOTT Forbici oculari	71
Uncino muscolar	587	WESTERMAN (Jensen) Cannule per biopsia	546
Uncino per cordone spermatico	327	WHITE Pinze per tonsille	237
Uncino per cordone spermatico	327	WICKHAM Pinza metti-rimouvi clips	215
Uncino vascolare	315	WICKHAM Pinze Bulldog	215
UNIVERSAL Forbici para fili	117	WIEN Portalegature	517
UNIVERSAL Forbici per bendaggi	136	WIENER Uncini per iris	302
UNIVERSAL Forbici per fili PROMEDU	134	WIGMORE Segha per gesso	556
UNIVERSAL Trequearti	541	WIJNEN Tubi per aspirazione	538,578
UNNA Tiracomedoni	31	WIJNEN Tubi per aspirazione per CHIRURGIA BARIATRICA	578
UNNA-VIDAL (GREG) Tiracomedoni con ago	31	WIKSTROEM Pinze emostatiche	235
USA-MODELO Forbici ombelicale	116	WILDE Pinze auricolari	189
USA-MODELO Pinza serratubi	292	WILDER Dilatatori per canale lacrimale	521
US-ARMY Divaricatori	329	WILLET Pinza per pericraneo	284
V			
Valigetta di plastica per seghe OSCILLOW	560	WILLIAMS Blefarostati	389
VAN ALEYA Trequearto per puntura del seno mascellare	542	WILLIAMS Pinze da presa per intestino e tessuti	245
VANNAS Forbici per iridectomia	74	WILMER Forbici oculari	68
VANNAS-MICRO Forbici per iridectomia	76,77,86,88	WINTER Pinze per aborto	287
VANNAS-TÜBINGEN Forbici per iridectomia	74	WISCONSIN-FOREGGER laringoscopii	41
VARADY strumenti per varici	544	WOLFF Pinze per rompere gesso	557
Varici, strumenti	543-544	WORST Sonda a pigtail	521
Vassoi per strumenti	612	WULLSTEIN Cannula de aspirazione e lavago	534
Vaughan bisturi per abscessi	61	WULLSTEIN Divaricatori autostatici	398
VERRES Aghi per il pneumo-peritoneo	547	WULLSTEIN Tubo aspirazione	532
VIDAL Raschiatoio per lupus	31	Y	
VIRCHOW Coltelli per cartilagini	60	YANKAUER Tubi per aspirazione	537
VIRCHOW Coltelli per il cervello	60	YANKAUER Tubi per aspirazione per CHIRURGIA BARIATRICA	537,577
VIRTUS (RALK) Pinze per scheggie	162	YASARGIL Forbici	88
VISE Micro-Pinze per legature	160	YASARGIL Micro-Forbici	88
VITRECTOMIA, Forbici	75	YASARGIL Pinze per tumori	179
VOLKMANN Divaricati	332-333	YOUNG Pinza per afferare la prostata	269
VOLKMANN Guanchi per ossa	335	YOUNG Pinza tiralingua	36
VOLLMAR Tirevene	543	Z	
W			
WACHENFELDT Pinza per applicare graffe	506	ZENKER Pinze per preparazione e legature	230
WAGENER Uncini auricolari	305	ZIEGLER Blefarostato	389
WAGNER Forbici fine per dissezione	105	ZIEGLER Riflettore frontale	20
WALDMANN Forbici per episiotomia	116	ZOELLNER Micro tubo per aspirazione	534
WALDMANN Forbici per episiotomia SUPERCUT	116		
WALKER Forbici per iridectomia	92		
WALTON Allargegesso	557		
WALTON Divaricatori autostatici	398		
WALTON Forbici per gesso	138		
WALTON Pinze per tamponi e spugne	295		
WALTON Segha per anelli	34		
WALTON-SELECT Segha per anelli	34		
WANGENSTEEN Pinza chirurgiche	154		
WANGENSTEEN Pinze anatomiche PROMEDUR	164		
WANGENSTEEN Portaghi	504		
WANGENSTEEN Portaghi PROMEDUR	494		

Kat.Nr.	Seite	Kat.Nr.	Seite	Kat.Nr.	Seite	Kat.Nr.	Seite	Kat.Nr.	Seite	Kat.Nr.	Seite
Cat.No.	Page	Cat.No.	Page	Cat.No.	Page	Cat.No.	Page	Cat.No.	Page	Cat.No.	Page
No. Réf.	Page	No. Réf.	Page	No. Réf.	Page	No. Réf.	Page	No. Réf.	Page	No. Réf.	Page
No. Réf.	Página	No. Réf.	Página	No. Réf.	Página	No. Réf.	Página	No. Réf.	Página	No. Réf.	Página
No. Cat.	Página	No. Cat.	Página	No. Cat.	Página	No. Cat.	Página	No. Cat.	Página	No. Cat.	Página
18.4130	.515	19.0322	.523	19.1021	.541	19.3125	.545	21.0030	.556	23.1221.28	.579
18.4131	.515	19.0323	.523	19.1022	.541	19.3300	.545	21.0050	.556	23.1221.38	.579
18.4132	.515	19.0324	.523	19.1023	.541	19.3399	.547	21.0060	.556	23.1222.28	.579
18.4133	.515	19.0325	.523	19.1024	.541	19.3400	.547	21.0070	.556	23.1222.38	.579
18.4140	.515	19.0332	.523	19.1025	.541	19.3401	.547	21.0100	.557	23.1223.28	.579
18.4150	.515	19.0351	.523	19.1026	.541	19.3402	.547	21.0102	.557	23.1223.38	.579
18.4190	.515	19.0352	.523	19.1030	.541	19.3403	.547	21.0110	.557	23.1224.28	.579
18.4191	.515	19.0353	.523	19.1031	.541	19.3404	.547	21.0120	.557	23.1224.38	.579
18.4211	.516	19.0354	.523	19.1032	.541	19.3405	.547	21.0130	.557	23.1225.28	.579
18.4212	.516	19.0355	.523	19.1033	.541	19.3500	.546	21.0140	.557	23.1225.38	.579
18.4213	.516	19.0356	.523	19.1034	.541	19.3510	.546	21.0150	.557	23.1226.28	.579
18.4241	.516	19.0363	.523	19.1035	.541	19.3550	.547	21.0200	.135	23.1226.38	.579
18.4243	.516	19.0371	.523	19.1036	.541	19.3552	.547	21.0202	.135	23.1227.28	.579
18.4245	.516	19.0372	.523	19.1050	.541	19.3554	.547	21.0204	.135	23.1227.38	.579
18.4250	.517	19.0373	.523	19.1199	.541	19.3556	.547	21.0205	.135	23.1228.28	.579
18.4255	.517	19.0374	.523	19.1200	.541	19.3600	.547	21.0206	.135	23.1228.38	.579
18.4261	.517	19.0500	.529	19.1201	.541	19.3602	.547	21.0206L	.135	23.1229.28	.579
18.4263	.517	19.0501	.529	19.1202	.541	19.3610	.547	21.0208	.135	23.1229.38	.579
18.4301	.517	19.0502	.529	19.1204	.541	19.5001	.548	21.0210	.135	23.1230.28	.579
18.4303	.517	19.0503	.529	19.1205	.541	19.5002	.548	21.0212	.135	23.1230.38	.579
18.4340	.517	19.0510	.529	19.1206	.541	19.5003	.548	21.0216	.135	23.1231.28	.579
18.4341	.517	19.0511	.529	19.1210	.541	19.5004	.548	21.0226	.135	23.1231.38	.579
		19.0512	.529	19.1211	.541	19.5005	.548	21.0228	.135	23.1232.28	.579
		19.0513	.529	19.1212	.541	19.5007	.548	21.0230	.135	23.1232.38	.579
19...		19.0520	.529	19.1213	.541	19.5011	.548	21.0241	.135	23.1233.28	.579
19.0101	.522	19.0521	.529	19.1220	.542	19.5012	.548	21.0250	.136	23.1233.38	.579
19.0102	.522	19.0522	.529	19.1300	.542	19.5013	.548	21.0252	.136	23.1234.28	.579
19.0103	.522	19.0523	.529	19.1310	.542	19.5014	.548	21.0260	.136	23.1234.38	.579
19.0104	.522	19.0523	.529	19.1311	.542	19.5015	.548	21.0270	.136	23.1235.28	.579
19.0105	.522	19.0530	.529	19.1312	.542	19.5017	.548	21.0272	.136	23.1235.38	.579
19.0106	.522	19.0531	.529	19.1320	.542	19.5021	.548	21.0274	.136	23.1236.28	.579
19.0109	.522	19.0532	.529	19.2000	.543	19.5022	.548	21.0280	.136	23.1236.38	.579
19.0110	.522	19.0533	.529	19.2001	.543	19.5023	.548	21.0300	.136	23.1237.28	.579
19.0111	.522	19.0540	.529	19.2002	.543	19.5024	.548	21.0310	.136	23.1237.38	.579
19.0112	.522	19.0550	.529	19.2003	.543	19.5025	.548	21.0500	.137	23.1238.28	.579
19.0113	.522	19.0553	.529	19.2006	.543	19.5027	.548	21.0510	.137	23.1238.38	.579
19.0114	.522	19.0710	.537	19.2009	.543	19.5031	.548	21.0512	.137	23.1239.28	.579
19.0115	.522	19.0711	.577	19.2012	.543	19.5032	.549	21.0514	.137	23.1239.38	.579
19.0116	.522	19.0712	.577	19.2015	.543	19.5033	.549	21.0540	.138	23.2000	.23
19.0117	.577	19.0713	.577	19.2018	.543	19.5034	.549	21.0545	.138	23.2897	.580
19.0119	.522	19.0715	.537	19.2019	.543	19.5035	.549	21.0550	.138	23.2898	.580
19.0120	.522	19.0718	.537	19.2101	.544	19.5037	.549	21.0560	.138	23.2899	.580
19.0121	.522	19.0719	.537	19.2102	.544	19.5801	.549	21.0580	.138	23.2921	.580
19.0122	.522	19.0720	.538	19.2103	.544	19.5802	.549	21.3005	.560	23.3301	.370
19.0123	.522	19.0721	.538	19.2104	.544	19.5803	.549	21.3006	.560	23.3302	.370
19.0124	.522	19.0722	.578	19.2105	.544	19.5804	.549	21.3007	.560	23.3303	.370
19.0125	.522	19.0723	.578	19.2106	.544	19.5810	.549	21.3008	.560	23.3304	.370
19.0126	.522	19.0724	.578	19.3000	.545	19.5812	.549	21.3009	.560	23.3305	.370
19.0127	.577	19.0726	.538	19.3001	.545	19.5813	.549	21.3010	.558	23.3310	.370
19.0128	.577	19.0727	.538	19.3010	.545	19.5814	.549	21.3011	.558	23.3312	.370
19.0200	.522	19.0738	.578	19.3011	.545	19.5816	.549	21.3019	.560	23.3320	.123
19.0201	.522	19.0746	.538	19.3020	.545	19.5820	.549	21.3030	.559	23.3325	.123
19.0202	.522	19.0747	.538	19.3021	.545	19.5881	.550	21.3039	.559		
19.0203	.522	19.0748	.538	19.3030	.545	19.5882	.550				
19.0204	.522	19.0750	.578	19.3040	.545	19.5883	.550				
19.0205	.522	19.0751	.539	19.3041	.545	19.5884	.550				
19.0206	.522	19.0752	.539	19.3043	.545	19.5885	.550	23.0251	.368	24.3071	.24
19.0207	.522	19.0753	.539	19.3044	.545	19.5889	.550	23.0252	.368	24.3072	.24
19.0210	.522	19.0754	.539	19.3051	.546	19.5891	.550	23.0253	.368	24.3073	.24
19.0211	.522	19.0760	.540	19.3053	.546	19.5892	.550	23.0255	.368	24.3074	.24
19.0212	.522	19.0761	.540	19.3060	.546	19.5893	.550	23.0330	.368		
19.0213	.522	19.0762	.540	19.3061	.546	19.5894	.550	23.0332	.368		
19.0214	.522	19.0763	.540	19.3062	.546	19.5895	.550	23.0360	.369		
19.0215	.522	19.0764	.540	19.3064	.546	19.5898	.550	23.0361	.369		
19.0216	.522	19.0765	.540	19.3065	.546	19.5899	.550	23.0362	.369		
19.0249	.524	19.0770	.540	19.3066	.546	19.5918	.552	23.0363	.369		
19.0250	.524	19.0771	.540	19.3100	.545	19.5922	.552	23.0790	.579		
19.0252	.524	19.0772	.540	19.3105	.545	19.5929	.552	23.0792	.579		
19.0302	.523	19.0773	.540	19.3110	.545			23.0794	.579		
19.0303	.523	19.0774	.540	19.3111	.545			23.0796	.579		
19.0320	.523	19.1010	.541	19.3115	.545			23.1220.28	.579		
19.0321	.523	19.1020	.541	19.3120	.545			23.1220.38	.579		
						1...					
						21.0010	.556				
						21.0020	.556				

Kat.Nr. Cat.No. No. Ref. No. Ref. No. Cat.	Seite Page Página Página	Kat.Nr. Cat.No. No. Ref. No. Ref. No. Cat.	Seite Page Página Página	Kat.Nr. Cat.No. No. Ref. No. Ref. No. Cat.	Seite Page Página Página	Kat.Nr. Cat.No. No. Ref. No. Ref. No. Cat.	Seite Page Página Página	Kat.Nr. Cat.No. No. Ref. No. Ref. No. Cat.	Seite Page Página Página	Kat.Nr. Cat.No. No. Ref. No. Ref. No. Cat.	Seite Page Página Página
27.0014	530	27.0181E	533	27.1160	309	27.2541	175	27.5156	448	28.0222T	181
27.0015	530	27.0182	533	27.1161	309	27.2542	175	27.5164	448	28.0223SD	181
27.0016	530	27.0183	533	27.1162	309	27.2560	175	27.5166	448	28.0223T	181
27.0017	530	27.0183E	533	27.1163	309	27.2562	175	27.5183	448	28.0224SD	181
27.0018	530	27.0184	533	27.1201	309	27.5000	446	27.5184	448	28.0224T	181
27.0019	530	27.0185	533	27.1202	309	27.5001	446	27.5185	448	28.0225SD	181
27.0020	530	27.0185E	533	27.1206	309	27.5021	446	27.5186	448	28.0225T	181
27.0021	530	27.0186	533	27.1210	309	27.5022	446	27.5187	448	28.0226SD	181
27.0022	530	27.0187	533	27.1211	309	27.5023	446	27.5199	448	28.0226T	181
27.0023	530	27.0190	533	27.1220	309	27.5024	446	27.5401	449	28.0227SD	181
27.0024	530	27.0191	533	27.1222	310	27.5025	446	27.5402	449	28.0227T	181
27.0025	530	27.0192	533	27.1226	310	27.5026	446	27.5403	449	28.0230SD	181
27.0026	530	27.0193	533	27.1228	310	27.5027	446	27.5404	449	28.0230T	181
27.0027	530	27.0194	533	27.1230	310	27.5030	450	27.5405	449	28.0231SD	181
27.0028	530	27.0195	533	27.1231	310	27.5031	450	27.5420	450	28.0231T	181
27.0029	530	27.0196	533	27.1232	310	27.5032	450	27.5421	450	28.0232SD	181
27.0030	530	27.0199	533	27.1240	310	27.5033	450	27.5430	450	28.0232T	181
27.0031	530	27.0702	455	27.1241	310	27.5034	450	27.5431	450	28.0233SD	181
27.0032	530	27.0705	457	27.1245	310	27.5050	445	27.5432	450	28.0233T	181
27.0033	530	27.0706	457	27.1246	310	27.5051	445	27.5433	450	28.0234SD	181
27.0034	530	27.0707	457	27.1250	326	27.5062	445	27.5434	450	28.0234T	181
27.0035	530	27.0708	457	27.1251	326	27.5063	445	27.5435	450	28.0235SD	181
27.0036	530	27.0709	457	27.1252	326	27.5071	445	27.5436	450	28.0235T	181
27.0037	530	27.0710	457	27.1253	326	27.5072	445	27.5437	450	28.0236SD	181
27.0038	530	27.0711	458	27.1254	326	27.5073	445	27.5438	450	28.0236T	181
27.0039	530	27.0712	458	27.1255	326	27.5074	445	27.5440	449	28.0240SD	184
27.0040	530	27.0713	458	27.1256	326	27.5075	445	27.5441	449	28.0240T	184
27.0041	530	27.0721	456	27.1257	326	27.5076	445	27.5500	451	28.0242SD	184
27.0042	530	27.0722	456	27.1258	326	27.5077	445	27.5501	451	28.0242T	184
27.0056	531	27.0723	456	27.1259	326	27.5078	445	27.5509	451	28.0244SD	184
27.0057	531	27.1000	460	27.1260	326	27.5081	445	27.5510	452	28.0244T	184
27.0066	531	27.1001	460	27.1261	326	27.5082	445	27.5511	452	28.0246SD	184
27.0067	531	27.1002	460	27.1305	311	27.5083	445	27.5519	452	28.0246T	184
27.0068	531	27.1003	460	27.1310	311	27.5084	445	27.5520	453	28.0250SD	184
27.0070	531	27.1005	460	27.1311	311	27.5085	445	27.5532	453	28.0250T	184
27.0071	531	27.1006	460	27.1312	311	27.5086	445	27.5534	453	28.0252SD	184
27.0072	531	27.1007	460	27.1313	311	27.5087	445	27.5536	453	28.0252T	184
27.0073	531	27.1008	460	27.1320	311	27.5088	445	27.5538	453	28.0254SD	184
27.0074	531	27.1010	460	27.1325	311	27.5091	445	27.5550	453	28.0254T	184
27.0075	531	27.1012	460	27.1330	311	27.5092	445	27.5570	24	28.0256SD	184
27.0076	531	27.1026	459	27.1340	311	27.5093	445			28.0256T	184
27.0077	531	27.1027	459	27.1390	312	27.5094	445	28...		28.0260SD	182
27.0078	531	27.1028	459	27.1391	312	27.5095	445	28.0011	176	28.0260T	182
27.0079	531	27.1029	459	27.1400	312	27.5096	445	28.0015	176	28.0261SD	182
27.0090	532	27.1031	460	27.1402	312	27.5097	445	28.0018	176	28.0261T	182
27.0091	532	27.1032	460	27.1404	312	27.5098	445	28.0030	176	28.0262SD	182
27.0094	532	27.1033	460	27.1406	312	27.5100	447	28.0032	176	28.0262T	182
27.0096	532	27.1034	460	27.1410	313	27.5101	447	28.0080	177	28.0263SD	182
27.0098	532	27.1034	460	27.1412	313	27.5110	447	28.0081	177	28.0263T	182
27.0100	532	27.1036	460	27.1413	313	27.5111	447	28.0082	177	28.0264SD	182
27.0101	532	27.1037	460	27.1420	314	27.5120	447	28.0083	177	28.0264T	182
27.0102	532	27.1038	460	27.1425	314	27.5121	447	28.0084	178	28.0265SD	182
27.0103	532	27.1039	460	27.1430	314	27.5122	448	28.0085	178	28.0265T	182
27.0170	533	27.1041	459	27.1431	314	27.5123	448	28.0086	178	28.0266SD	182
27.0170E	533	27.1042	459	27.1432	314	27.5124	448	28.0087	178	28.0266T	182
27.0171	533	27.1043	459	27.1433	314	27.5125	448	28.0101	179	28.0267SD	182
27.0171E	533	27.1044	459	27.1451	443	27.5126	448	28.0103	179	28.0267T	182
27.0172	533	27.1045	459	27.1455	443	27.5132	448	28.0105	179	28.0270SD	182
27.0172E	533	27.1046	459	27.1460	443	27.5133	448	28.0113	179	28.0270T	182
27.0173	533	27.1050	459	27.1461	443	27.5134	448	28.0115	179	28.0271SD	182
27.0173E	533	27.1051	459	27.1465	444	27.5135	448	28.0123	179	28.0271T	182
27.0174	533	27.1052	459	27.1466	444	27.5136	448	28.0125	179	28.0272SD	182
27.0174E	533	27.1053	459	27.1480	442	27.5142	448	28.0130	180	28.0272T	182
27.0175	533	27.1054	459	27.1481	442	27.5143	448	28.0132	180	28.0273SD	182
27.0175E	533	27.1055	459	27.1485	442	27.5144	448	28.0136	180	28.0273T	182
27.0176	533	27.1056	459	27.1486	442	27.5145	448	28.0138	180	28.0274SD	182
27.0176E	533	27.1057	459	27.1487	442	27.5146	448	28.0220SD	181	28.0274T	182
27.0179	533	27.1060	459	27.2500	175	27.5152	448	28.0220T	181	28.0275SD	182
27.0179E	533	27.1061	459	27.2520	175	27.5153	448	28.0221SD	181	28.0275T	182
27.0180	533	27.1150	309	27.2521	175	27.5154	448	28.0221T	181	28.0276SD	182
27.0181	533	27.1152	309	27.2540	175	27.5155	448	28.0222SD	181	28.0276T	182

Kat.Nr. Cat.No. No. Réf. No. Ref. No. Cat.	Seite Page Page Página Pagina	Kat.Nr. Cat.No. No. Réf. No. Ref. No. Cat.	Seite Page Page Página Pagina	Kat.Nr. Cat.No. No. Réf. No. Ref. No. Cat.	Seite Page Page Página Pagina	Kat.Nr. Cat.No. No. Réf. No. Ref. No. Cat.	Seite Page Page Página Pagina	Kat.Nr. Cat.No. No. Réf. No. Ref. No. Cat.	Seite Page Page Página Pagina	Kat.Nr. Cat.No. No. Réf. No. Ref. No. Cat.	Seite Page Page Página Pagina
28.0277SD	182	28.0374T	180	28.2210	79	28.2622	86	28.3600S	483	28.3640	484
28.0277T	182	28.0375SD	180	28.2211	79	28.2623	86	28.3600SD	483	28.3640S	484
28.0280SD	183	28.0375T	180	28.2212	79	28.2624	86	28.3601	483	28.3640SD	484
28.0280T	183	28.0382SD	181	28.2213	79	28.2625	86	28.3601S	483	28.3641	484
28.0281SD	183	28.0382T	181	28.2214	79	28.2628	86	28.3601SD	483	28.3641S	484
28.0281T	183	28.0383SD	181	28.2220	82	28.2629	86	28.3602	483	28.3641SD	484
28.0282SD	183	28.0383T	181	28.2221	82	28.2640	86	28.3602S	483	28.3642	484
28.0282T	183	28.0384SD	181	28.2222	82	28.2641	86	28.3602SD	483	28.3642S	484
28.0283SD	183	28.0384T	181	28.2223	82	28.2656	87	28.3603	483	28.3642SD	484
28.0283T	183	28.0385SD	181	28.2225	82	28.2657	87	28.3603S	483	28.3642SD/SL	484
28.0284SD	183	28.0385T	181	28.2230	82	28.2659	87	28.3603SD	483	28.3642SL	484
28.0284T	183	28.0392SD	181	28.2231	82	28.2711	88	28.3604	483	28.3643	484
28.0285SD	183	28.0392T	181	28.2310	83	28.2712	88	28.3604S	483	28.3643S	484
28.0285T	183	28.0393SD	181	28.2311	83	28.2713	88	28.3604SD	483	28.3643SD	484
28.0286SD	183	28.0393T	181	28.2313	83	28.2714	88	28.3605	483	28.3644	484
28.0286T	183	28.0394SD	181	28.2315	83	28.2715	88	28.3605S	483	28.3644S	484
28.0287SD	183	28.0394T	181	28.2350	83	28.2716	88	28.3605SD	483	28.3644SD	484
28.0287T	183	28.0395SD	181	28.2351	83	28.2717	88	28.3606	483	28.3644SD/SL	484
28.0290SD	183	28.0395T	181	28.2400	83	28.2718	88	28.3606S	483	28.3645	484
28.0290T	183	28.0490	188	28.2460	80	28.2719	88	28.3606SD	483	28.3645S	484
28.0291SD	183	28.0491	188	28.2460T	80	28.2720	88	28.3607	483	28.3645SD	484
28.0291T	183	28.0492	188	28.2461	80	28.2721	88	28.3607S	483	28.3646	484
28.0292SD	183	28.0495	188	28.2461T	80	28.2722	88	28.3607SD	483	28.3646S	484
28.0292T	183	28.0496	188	28.2462	80	28.2723	88	28.3610	483	28.3646SD	484
28.0293SD	183	28.0497	188	28.2462T	80	28.2724	88	28.3610S	483	28.3647	484
28.0293T	183	28.0600	186	28.2463	80	28.2728	88	28.3610SD	483	28.3647S	484
28.0294SD	183	28.0602	186	28.2463T	80	28.3100	474	28.3611	483	28.3647SD	484
28.0294T	183	28.0604	186	28.2464	80	28.3101	474	28.3611S	483	28.3662	482
28.0295SD	183	28.0606	186	28.2464T	80	28.3102	474	28.3611SD	483	28.3662D	482
28.0295T	183	28.0608	186	28.2470	80	28.3103	474	28.3612	483	28.3664	482
28.0296SD	183	28.0610	186	28.2470T	80	28.3130	475	28.3612S	483	28.3664D	482
28.0296T	183	28.0612	186	28.2471	80	28.3131	475	28.3612SD	483	28.3700	485
28.0297SD	183	28.0614	186	28.2471T	80	28.3132	475	28.3613	483	28.3700S	485
28.0297T	183	28.0616	186	28.2472	80	28.3133	475	28.3613S	483	28.3700SD	485
28.0320S	185	28.0618	186	28.2472T	80	28.3140	476	28.3613SD	483	28.3701	485
28.0320T	185	28.0622	186	28.2473	80	28.3141	476	28.3614	483	28.3701S	485
28.0322S	185	28.0700	187	28.2473T	80	28.3142	477	28.3614S	483	28.3701SD	485
28.0322T	185	28.0702	187	28.2474	80	28.3143	477	28.3614SD	483	28.3702	485
28.0324S	185	28.0704	187	28.2474T	80	28.3150	476	28.3615	483	28.3702S	485
28.0324T	185	28.0710	187	28.2480	81	28.3151	476	28.3615S	483	28.3702SD	485
28.0326S	185	28.0712	187	28.2481	81	28.3152	477	28.3615SD	483	28.3703	485
28.0326T	185	28.0714	187	28.2482	81	28.3153	477	28.3616	483	28.3703S	485
28.0330S	185	28.0715	187	28.2483	81	28.3154	478	28.3616S	483	28.3703SD	485
28.0330T	185	28.0716	187	28.2484	81	28.3155	478	28.3616SD	483	28.4010	89
28.0332S	185	28.0717	187	28.2490	81	28.3156	478	28.3617	483	28.4012	89
28.0332T	185	28.2100	77	28.2491	81	28.3157	478	28.3617S	483	28.4013	89
28.0334S	185	28.2101	77	28.2492	81	28.3242	479	28.3617SD	483	28.4015	89
28.0334T	185	28.2102	77	28.2493	81	28.3243	479	28.3630	484	28.4017	89
28.0336S	185	28.2103	77	28.2494	81	28.3252	479	28.3630S	484	28.4019	89
28.0336T	185	28.2104	77	28.2560	84	28.3253	479	28.3630SD	484	28.4020	89
28.0342SD	184	28.2105	77	28.2560T	84	28.3254	480	28.3631	484	28.4040	89
28.0342T	184	28.2110	76	28.2561	84	28.3255	480	28.3631S	484	28.4042	89
28.0344SD	184	28.2111	76	28.2561T	84	28.3256	480	28.3631SD	484	28.4043	89
28.0344T	184	28.2112	76	28.2562	84	28.3257	480	28.3632	484	28.4045	89
28.0352SD	184	28.2113	76	28.2562T	84	28.3400	481	28.3632S	484	28.4047	89
28.0352T	184	28.2114	76	28.2563	84	28.3402	481	28.3632SD	484	28.4049	89
28.0354SD	184	28.2115	76	28.2563T	84	28.3404	481	28.3633	484	28.4300	90
28.0354T	184	28.2120	78	28.2564	84	28.3406	481	28.3633S	484	28.4301	90
28.0362SD	180	28.2121	78	28.2564T	84	28.3408	481	28.3633SD	484	28.4303	90
28.0362T	180	28.2122	78	28.2565	84	28.3450	481	28.3634	484	28.4400	90
28.0363SD	180	28.2123	78	28.2565T	84	28.3501	486	28.3634S	484	28.4401	90
28.0363T	180	28.2124	78	28.2566	84	28.3504	486	28.3634SD	484	28.7050	19
28.0364SD	180	28.2125	78	28.2567	84	28.3505	486	28.3635	484	28.7055	19
28.0364T	180	28.2133	78	28.2600	85	28.3506	486	28.3635S	484	28.7057	19
28.0365SD	180	28.2150	78	28.2601	85	28.3507	486	28.3635SD	484	28.7058	19
28.0365T	180	28.2151	78	28.2602	85	28.3509	486	28.3636	484	28.7059	19
28.0372SD	180	28.2200	79	28.2603	85	28.3520	487	28.3636S	484		
28.0372T	180	28.2201	79	28.2605	85	28.3521	487	28.3636SD	484		
28.0373SD	180	28.2202	79	28.2608	85	28.3522	487	28.3637	484		
28.0373T	180	28.2203	79	28.2609	85	28.3523	487	28.3637S	484		
28.0374SD	180	28.2204	79	28.2620	86	28.3600	483	28.3637SD	484		
										30..	
										30.0003	388
										30.0004	388
										30.0005	388

Kat.Nr. Cat.No. No. Ref. No. Cat.	Seite Page Página	Kat.Nr. Cat.No. No. Ref. No. Cat.	Seite Page Página	Kat.Nr. Cat.No. No. Ref. No. Cat.	Seite Page Página	Kat.Nr. Cat.No. No. Ref. No. Cat.	Seite Page Página	Kat.Nr. Cat.No. No. Ref. No. Cat.	Seite Page Página	Kat.Nr. Cat.No. No. Ref. No. Cat.	Seite Page Página
30.0007	388	30.0551	304	30.2062	191	30.2563	199	30.3552	67	30.4400	75
30.0008	388	30.0552	304	30.2063	191	30.2570	199	30.3553	67	30.4403	75
30.0010	388	30.0555	304	30.2065	191	30.2575	199	30.3555	66	30.4406	75
30.0020	388	30.0560	304	30.2066	191	30.2600	201	30.3600	67	30.4409	75
30.0030	388	30.0562	304	30.2067	191	30.2602	201	30.3600SC	67		
30.0040	388	30.0570	303	30.2069	191	30.2610	201	30.3601	67	32...	
30.0042	388	30.0571	303	30.2070	192	30.2615	201	30.3601SC	67	32.0220	456
30.0050	388	30.0581	304	30.2071	192	30.2630	201	30.3606	67	32.0229	456
30.0060	388	30.0582	304	30.2076	192	30.2650	200	30.3606SC	67	32.0280	551
30.0070	388	30.0590	302	30.2077	192	30.2660	201	30.3607	67	32.0281	551
30.0072	388	30.1400	23	30.2080	192	30.2682	201	30.3607SC	67	32.0282	551
30.0076	388	30.1402	23	30.2082	192	30.2684	201	30.3610	68	32.0283	551
30.0080	389	30.1408	23	30.2086	192	30.2685	201	30.3611	68	32.0284	551
30.0082	389	30.1409	23	30.2088	192	30.2687	200	30.3612	68	32.0285	551
30.0084	389	30.1410	24	30.2090	193	30.2689	200	30.3613	68	32.0286	551
30.0085	389	30.1415	24	30.2091	193	30.2700	202	30.3614	68	32.0287	551
30.0090	389	30.1601	521	30.2094	193	30.2702	202	30.3615	68	32.0288	551
30.0094	389	30.1602	521	30.2111	193	30.2705	202	30.3620	68	32.0289	551
30.0095	389	30.1603	521	30.2120	195	30.2707	202	30.3622	68	32.0296	552
30.0100	389	30.1605	521	30.2121	195	30.2708	202	30.3660	69	32.0297	552
30.0110	389	30.1606	521	30.2122	195	30.2709	202	30.3661	69	32.0640	189
30.0115	389	30.1620	521	30.2125	195	30.2720	203	30.3663	69	32.0642	189
30.0120	389	30.1630	521	30.2126	195	30.2722	203	30.3671	69	32.0650	189
30.0130	389	30.1640	521	30.2127	195	30.2725	200	30.3673	69	32.0660	189
30.0135	389	30.1642	521	30.2129	195	30.2730	203	30.3703	67	32.0662	189
30.0136	389	30.1700	520	30.2137	193	30.2740	203	30.3704	67	32.1160	534
30.0140	389	30.1701	520	30.2138	193	30.2742	203	30.3902	70	32.1161	534
30.0150	389	30.1702	520	30.2140	194	30.2744	203	30.3903	70	32.1162	534
30.0160	390	30.1703	520	30.2141	194	30.2746	203	30.3910	70	32.1163	534
30.0162	390	30.1704	520	30.2150	194	30.2748	203	30.3911	70	32.1166	534
30.0170	390	30.1705	520	30.2152	194	30.2811	163	30.3912	70	32.1167	534
30.0181	390	30.1706	520	30.2154	194	30.2840	163	30.3914	70	32.1168	534
30.0182	390	30.1707	520	30.2156	194	30.2850	163	30.3915	70	32.1169	534
30.0190	390	30.1708	520	30.2158	194	30.2852	163	30.3917	70	32.1170	534
30.0191	390	30.1738	520	30.2170	193	30.2862	163	30.3918	70	32.1171	534
30.0192	390	30.1740	520	30.2300	196	30.2865	163	30.3920	71	32.1172	534
30.0193	390	30.1741	520	30.2302	196	30.2870	163	30.3922	71	32.1173	534
30.0400	302	30.1742	520	30.2310	196	30.2885	163	30.3924	71	32.1174	534
30.0401	302	30.1743	520	30.2312	196	30.2900	204	30.3930	71	32.1175	534
30.0414	302	30.1744	520	30.2314	196	30.2920	204	30.3931	71	32.1177	534
30.0416	302	30.1745	520	30.2316	196	30.2930	204	30.3932	71	32.1178	534
30.0418	302	30.1746	520	30.2320	196	30.2931	204	30.3936	71	32.1179	534
30.0420	302	30.1747	520	30.2330	196	30.2950	205	30.3938	71	32.1180	534
30.0430	303	30.1748	520	30.2350	196	30.2951	205	30.3944	71	32.1181	534
30.0431	303	30.1760	520	30.2352	196	30.2960	204	30.3945	71	32.1185	534
30.0432	303	30.1761	520	30.2380	197	30.2961	204	30.3951	71	32.1187	534
30.0433	303	30.1762	520	30.2381	197	30.2970	205	30.3953	71	32.1188	534
30.0500	302	30.1763	520	30.2382	197	30.2977	205	30.3961	72	32.1189	534
30.0501	302	30.1764	520	30.2383	197	30.2980	205	30.3963	72	32.1190	535
30.0502	303	30.1765	520	30.2390	197	30.2990	205	30.3970	72	32.1191	535
30.0503	303	30.2000	140	30.2510	198	30.2991	205	30.3971	72	32.1193	535
30.0510	303	30.2000T	140	30.2512	198	30.3000	206	30.3973	72	32.1194	535
30.0511	303	30.2001	140	30.2514	198	30.3001	206	30.3974	72	32.1195	535
30.0512	303	30.2001T	140	30.2515	198	30.3002	206	30.3975	73	32.1361	305
30.0513	303	30.2003	140	30.2516	198	30.3014	206	30.3977	73	32.1362	305
30.0514	303	30.2003T	140	30.2517	198	30.3015	206	30.4011	73	32.1363	305
30.0515	302	30.2004	140	30.2518	198	30.3020	206	30.4013	73	32.1364	305
30.0516	302	30.2005	140	30.2519	198	30.3030	207	30.4015	73	32.1365	305
30.0520	304	30.2007	140	30.2520	198	30.3050	207	30.4017	73	32.1366	305
30.0521	304	30.2009	140	30.2522	198	30.3501	66	30.4100	74	32.1367	305
30.0522	304	30.2010	147	30.2522T	198	30.3502	66	30.4101	74	32.1368	305
30.0523	304	30.2011	147	30.2530	198	30.3503	66	30.4103	74	32.1376	305
30.0524	304	30.2013	147	30.2540	198	30.3511	66	30.4105	74	32.1377	305
30.0525	304	30.2014	147	30.2542	198	30.3513	66	30.4110	74	32.1378	305
30.0526	304	30.2015	147	30.2543	198	30.3520	66	30.4111	74	32.1380	305
30.0527	304	30.2017	147	30.2548	198	30.3521	66	30.4113	74	32.1382	305
30.0528	304	30.2020	191	30.2550	199	30.3522	66	30.4120	74		
30.0529	304	30.2050	191	30.2551	199	30.3523	66	30.4121	74		
30.0530	304	30.2051	191	30.2554	199	30.3530	67	30.4143	74		
30.0531	304	30.2056	191	30.2555	199	30.3531	67	30.4145	74		
30.0550	304	30.2057	191	30.2560	199	30.3541	66	30.4147	74		
										33...	
										33.0222	122
										33.0250	122
										33.0440	190

Kat.Nr. Cat.No. No. Réf. No. Ref. No. Cat.	Seite Page Page Página Pagina	Kat.Nr. Cat.No. No. Réf. No. Ref. No. Cat.	Seite Page Page Página Pagina	Kat.Nr. Cat.No. No. Réf. No. Ref. No. Cat.	Seite Page Page Página Pagina	Kat.Nr. Cat.No. No. Réf. No. Ref. No. Cat.	Seite Page Page Página Pagina	Kat.Nr. Cat.No. No. Réf. No. Ref. No. Cat.	Seite Page Page Página Pagina	Kat.Nr. Cat.No. No. Réf. No. Ref. No. Cat.	Seite Page Page Página Pagina
33.0446	190	34.0307	237	3 ...		40.3002	525	41.0050V	216	48.0030	244
33.0450	190	34.0309	237	36.0120	391	40.3003	525	41.0051A	216	48.0032	244
33.0452	190	34.0311	237	36.0400	123	40.3004	525	41.0051V	216	48.0034	244
33.0460	190	34.0313	237	36.0500	322	40.3005	525	41.0052A	216	48.0035	244
33.0462	190	34.0321	237	36.0502	322	40.3006	525	41.0052V	216	48.0036	244
33.0465	190	34.0323	237	36.0503	322	40.3007	525	41.0053A	216	48.0038	244
33.0467	190	34.0327	238	36.0504	322	40.3008	525	41.0053V	216	48.0040	245
33.1100	542	34.0329	238	36.0550	322	40.3009	525	41.0054A	216	48.0045	245
33.1102	542	34.0330	238	36.0560	322	40.3010	525	41.0054V	216	48.0050	245
33.1103	542	34.0331	238	36.0600	322	40.3011	525	41.0055A	216	48.0062	245
33.1104	542	34.0333	238			40.3012	525	41.0055V	216	48.0064	245
33.1110	542	34.0335	238	4 ...		40.3030	525	41.0056A	216	48.0066	245
33.1120	524	34.0350	238	40.0381	382	40.3031	525	41.0056V	216	48.0068	245
33.1122	524	34.3980	371	40.0382	382	40.3032	525	41.0057A	216	48.0069	573
33.1124	524	34.3982	371	40.0383	382	40.3033	525	41.0057V	216	48.0072	246
33.1125	524	34.3984	371	40.0384	382	40.3034	525	41.0061A	216	48.0076	246
33.1130	535	34.3986	371	40.0384	382	40.3035	525	41.0061V	216	48.0082	246
33.1131	535	34.3988	371	40.0385	382	40.3036	525	41.0063A	216	48.0086	246
33.1132	535	34.3989	371	40.0386	382	40.3037	525	41.0063V	216	48.0088	246
33.1135	535	34.3990	371	40.0391	384	40.3038	525	41.0065A	216	48.0089	247
33.1136	535	34.3992	371	40.0392	384	40.3039	525	41.0065V	216	48.0090	247
33.1137	535	34.3994	371	40.0393	384	40.3040	525	41.0067A	216	48.0092	247
33.1154	535	34.3996	371	40.0394	384	40.3041	525	41.0067V	216	48.0094	247
33.1155	535	34.3998	371	40.0395	384	40.3042	525	41.0069	216	48.0094AT	247
33.1156	535	34.3999	371	40.0396	384	40.3103	536	41.0080	215	48.0098	247
33.1160	537	34.4000	373	40.0400	384	40.3104	536	41.0081	215	48.0098AT	247
33.1170	535	34.4002	373	40.0402	384	40.3105	536	41.0082	215	48.0099	247
33.1180	535	34.4020	373	40.0410	383	40.3106	536	41.0083	215	48.0100	249
33.1204	536	34.4022	373	40.0411	383	40.3400	409	41.0084	215	48.0101	249
33.1205	536	34.4030	375	40.0412	383	40.4202	543	41.0085	215	48.0102	249
33.1214	536	34.4040	373	40.0413	383	40.4203	543	41.0089	215	48.0103	249
33.1215	536	34.4042	373	40.0670	461	40.4204	543	41.0090	217	48.0104	249
33.1220	536	34.4100	372	40.0701	239	40.4206	543	41.0091	217	48.0105	249
33.1221	536	34.4102	372	40.0702	239	40.4207	543	41.0092	217	48.0106	249
33.1222	536	34.4103	372	40.0705	572	40.4208	543	41.0093	217	48.0107	249
33.1223	536	34.4104	372	40.0713	239	40.4210	543	41.0094	217	48.0110	250
33.1890	536	34.4106	372	40.0714	239	40.4212	543	41.0095	217	48.0111	250
33.1910	306	34.4108	372	40.0720	239	40.4214	543	41.0099	217	48.0112	250
33.1911	306	34.4110	372	40.0730	240	40.4219	543	41.0100	217	48.0113	250
33.1912	306	34.4120	372	40.0731	240			41.0101	217	48.0114	250
33.1915	306	34.4122	372	40.0732	240	4 ...		41.0110	217	48.0115	250
33.1917	306	34.4124	372	40.0740	240	41.0000	212	41.0111	217	48.0118	251
33.1920	306	34.4126	372	40.0742	240	41.0001	212	41.0115	217	48.0119	251
33.1921	306	34.4128	372	40.0750	241	41.0005	212	41.0116	217	48.0120	251
33.1922	306	34.4130	372	40.0751	241	41.0006	212	41.0120	217	48.0121	251
33.1923	306	34.4140	374	40.0761	241	41.0010	212	41.0121	217	48.0122	252
33.1924	306	34.4145	374	40.0763	241	41.0011	212	41.0130	218	48.0123	252
33.1925	306	34.4146	375	40.0900	242	41.0015	212	41.0132	218	48.0125	253
33.1926	306	34.4150	376	40.0902	242	41.0016	212	41.0134	218	48.0126	253
33.1927	306	34.4152	376	40.0904	242	41.0018	212	41.0136	218	48.0130	253
33.1929	307	34.4154	376	40.2800	525	41.0019	212	41.0138	218	48.0131	253
33.1930	307	34.4156	376	40.2801	525	41.0020	213	41.0140	219	48.0132	253
33.1932	307	34.4160	377	40.2802	525	41.0021	213	41.0144	219	48.0140	254
33.1935	307	34.4170	377	40.2803	525	41.0022	213	41.0146	219	48.0141	254
33.1938	307	34.4172	377	40.2804	525	41.0023	213	41.0147	219	48.0150	255
33.1940	307	34.4200	378	40.2805	525	41.0024	213			48.0151	255
33.1950	307	34.4202	378	40.2806	525	41.0025	213	4 ...		48.0152	255
33.1952	307	34.4205	378	40.2807	525	41.0028	214	46.0169	424	48.0153	255
33.1960	307	34.4207	378	40.2808	525	41.0030	214			48.0154	255
33.1962	307	34.4210	380	40.2810	525	41.0031	214			48.0155	255
33.1966	308	34.4215	380	40.2820	525	41.0032	214	4 ...		48.0156	255
33.1970	308	34.4220	379	40.2821	525	41.0033	214	48.0004	243	48.0157	255
33.1972	308	34.4225	379	40.2822	525	41.0034	214	48.0006	243	48.0158	255
33.1975	308	34.4250	381	40.2823	525	41.0035	214	48.0010	243	48.0159	255
33.1976	308	34.4252	381	40.2824	525	41.0037	214	48.0011	243	48.0160	256
33.2901	123	34.4255	381	40.2825	525	41.0040	215	48.0014	243	48.0161	256
		34.4260	381	40.2826	525	41.0041	215	48.0016	243	48.0162	256
34...		34.4265	381	40.2827	525	41.0042	215	48.0019	572	48.0163	256
34.0070	373	34.4275	381	40.2828	525	41.0043	215	48.0020	244	48.0164	256
34.0303	237			40.2830	525	41.0044	215	48.0024	244	48.0165	256
34.0305	237			40.3000	525	41.0045	215	48.0028	244	48.0170	257
				40.3001	525	41.0050A	216	48.0029	244		

Kat.Nr. Cat.No. No. Ref. No. Ref. No. Cat.	Seite Page Page Página Pagina	Kat.Nr. Cat.No. No. Ref. No. Ref. No. Cat.	Seite Page Page Página Pagina	Kat.Nr. Cat.No. No. Ref. No. Ref. No. Cat.	Seite Page Page Página Pagina	Kat.Nr. Cat.No. No. Ref. No. Ref. No. Cat.	Seite Page Page Página Pagina	Kat.Nr. Cat.No. No. Ref. No. Ref. No. Cat.	Seite Page Page Página Pagina	Kat.Nr. Cat.No. No. Ref. No. Ref. No. Cat.	Seite Page Page Página Pagina
48.0172	257	50.0330	265	5 ...		58.0600	28	80.2074	609	80.4040	607
48.0180	257	50.0340	267	56.0010	25	58.0601	28	80.2076	609	80.4042	607
48.0184	258	50.0342	267	56.0020	25	58.0621	28,33	80.2078	609	80.4044	607
48.0186	258	50.0344	267	56.0030	25	58.0625	33	80.2090	609	80.4046	607
48.0190	259	50.0346	267	56.0060	116	58.0631	29	80.2100	610	80.4048	607
48.0191	259	50.0347	267	56.0601	116	58.0637	29	80.2101	610	80.4050	607
48.0200	260	50.0348	267	56.0800	284	58.0638	29	80.2102	610	80.4052	607
48.0201	260	50.0350	267	56.0801	284	58.0650	33	80.2104	610	80.4054	607
48.0203	260	50.0401	268	56.0805	284	58.0652	33	80.2200	610	80.4056	607
48.0204	260	50.0402	268	56.0820	285	58.0700	30	80.2202	610	80.4058	607
48.0205	260			56.0880	285	58.0710	30	80.2204	610	80.4060	607
48.0207	260	5 ...		56.0882	285	58.0712	30	80.2206	610	80.4062	607
48.0300	261	51.0004	269	56.0890	285	58.0715	30	80.2208	610	80.4064	607
48.0312	261	51.0020	464	56.0896	286	58.1000	30	80.2210	610	80.4100	612
48.0313	261	51.0040	269	56.0898	286	58.1001	30	80.2240	610	80.4101	612
48.0350	261	51.0041	269	56.0900	287	58.1002	30	80.2242	610	80.4102	612
48.1030	462	51.0042	269	56.0910	287	58.1003	30	80.2244	610	80.4103	612
48.1050	462	51.0060	327	56.0911	287	58.1004	30	80.2246	610	80.4104	612
48.1051	462	51.0070	464	56.1000	287	58.1040	30	80.2248	610	80.6001	592
48.1052	462	51.0072	465	56.1001	287			80.2250	610	80.6002	592
48.1053	462	51.0080	464	56.1002	287	0...		80.2252	610	80.6003	592
48.1054	462	51.0090	465	56.1003	287	60.0001	584	80.2254	610	80.6004	592
48.1060	463	51.0097	465	56.1004	287	60.0100	585	80.2256	610	80.6005	592
48.1070	463	51.0098	465	56.1005	287	60.0110	585	80.2258	610	80.6006	592
48.1080	463	51.0099	465			60.0118	586	80.2260	610	80.6011	592
48.1301	526			5 ...		60.0119	586	80.2262	610	80.6012	592
48.1302	526			58.0010	31	60.0125	586	80.2270	610	80.6013	592
48.1303	526	55...		58.0100	31	60.0131	586	80.2272	610	80.6014	592
48.1310	526	55.0500	407	58.0110	31	60.0132	586	80.2280	611	80.6015	592
48.1602	529	55.0530	466	58.0120	31	60.0133	586	80.2282	611	80.6016	592
48.1603	529	55.0532	466	58.0130	31	60.0134	586	80.2284	611	80.6021	592
		55.0550	466	58.0140	31	60.0137	586	80.2286	611	80.6022	592
50...		55.0930	276	58.0160	31	60.0138	586	80.2288	611	80.6023	592
50.0010	527	55.0932	276	58.0165	31	60.1000	587	80.2290	611	80.6024	592
50.0061	527	55.0934	276	58.0203	32	60.1001	587	80.2292	611	80.6025	592
50.0062	527	55.0936	276	58.0204	32	60.1020	587	80.2300	611	80.6026	592
50.0063	527	55.0938	277	58.0205	32	60.1021	587	80.2302	611	80.6031	592
50.0100	528	55.0940	277	58.0206	32	60.1030	587	80.2310	611	80.6032	592
50.0103	528	55.0944	277	58.0210	32	60.1100	587	80.2315	611	80.6033	592
50.0104	528	55.0947	278	58.0211	32	60.1200	587	80.2400	612	80.6034	592
50.0105	528	55.0948	278	58.0212	32	60.1300	587	80.2401	612	80.6035	592
50.0106	528	55.0949	278	58.0240	32	60.2001	588	80.2402	612	80.6036	592
50.0107	528	55.0951	279	58.0252	32	60.2002	588	80.2406	612	80.6041	592
50.0108	528	55.0956	279	58.0253	32	60.2003	588	80.2407	612	80.6042	592
50.0109	528	55.0962	279	58.0254	32	60.2004	588	80.2408	612	80.6043	592
50.0110	528	55.0963	279	58.0255	32	60.2005	588	80.2430	612	80.6044	592
50.0111	528	55.0965	280	58.0256	32	60.2006	588	80.2432	612	80.6045	592
50.0120	528	55.0968	280	58.0257	32	60.2011	588	80.2434	612	80.6046	592
50.0121	528	55.0970	280	58.0258	32	60.2012	588	80.2436	612	80.6203	593
50.0122	528	55.0971	280	58.0260	32	60.2013	588	80.2438	612	80.6205	593
50.0123	528	55.0973	281	58.0300	33	60.2014	588	80.3112	607	80.6207	593
50.0124	528	55.0975	281	58.0309	33	60.2015	588	80.3114	607	80.6210	593
50.0125	528	55.0977	281	58.0320	33	60.2016	588	80.3116	607	80.6231	593
50.0126	528	55.0980	281	58.0350	34			80.3162	607	80.6232	593
50.0127	528	55.0981	281	58.0359	34	0...		80.3164	607	80.6240	593
50.0128	528	55.0982	281	58.0360	34	80.0010	608	80.3166	607	80.6240	593
50.0129	528	55.0983	281	58.0369	34	80.0012	608	80.3190	606	80.6301	594
50.0130	528	55.0984	281	58.0370	34	80.0014	608	80.4002	607	80.6302	594
50.0131	528	55.1500	282	58.0379	34	80.1000	608	80.4004	607	80.6303	594
50.0132	528	55.1510	282	58.0380	34	80.1006	607	80.4006	607	80.6304	594
50.0133	528	55.1511	283	58.0389	34	80.1002	608	80.4008	607	80.6305	594
50.0140	527	55.1520	283	58.0501	28	80.1010	608	80.4010	607	80.6306	594
50.0300	264	55.1551	327	58.0517	33	80.1012	608	80.4012	607	80.6311	594
50.0301	264	55.1552	327	58.0520	28	80.2000	608	80.4014	607	80.6312	594
50.0311	264	55.1553	327	58.0522	28	80.2009	608	80.4016	607	80.6313	594
50.0313	264	55.1554	327	58.0530	28	80.2020	609	80.4018	607	80.6314	594
50.0315	264	55.1555	327	58.0540	28	80.2030	609	80.4020	607	80.6315	594
50.0317	264	55.1561	327	58.0550	28	80.2031	609	80.4022	607	80.6316	594
50.0320	265	55.1562	327	58.0551	28	80.2032	609	80.4024	607	80.6321	594
50.0321	265			58.0553	28	80.2060	609	80.4026	607	80.6322	594
50.0325	265			58.0555	28	80.2070	609	80.4028	607	80.6323	594
						80.2072	609			80.6324	594

Kat.Nr. Cat.No. No. Réf. No. Ref. No. Cat.	Seite Page Page Página Pagina	Kat.Nr. Cat.No. No. Réf. No. Ref. No. Cat.	Seite Page Page Página Pagina	Kat.Nr. Cat.No. No. Réf. No. Ref. No. Cat.	Seite Page Page Página Pagina	Kat.Nr. Cat.No. No. Réf. No. Ref. No. Cat.	Seite Page Page Página Pagina	Kat.Nr. Cat.No. No. Réf. No. Ref. No. Cat.	Seite Page Page Página Pagina	Kat.Nr. Cat.No. No. Réf. No. Ref. No. Cat.	Seite Page Page Página Pagina
80.6325	.594	80.7312	.598	80.8120	.604						
80.6326	.594	80.7313	.598	80.8131	.604						
80.6503	.595	80.7314	.598	80.8132	.604						
80.6505	.595	80.7315	.598	80.8133	.604						
80.6507	.595	80.7316	.598	80.8140	.605						
80.6510	.595	80.7321	.598	80.8141	.605						
80.6531	.595	80.7322	.598	80.8142	.605						
80.6532	.595	80.7323	.598	80.8150	.605						
80.6540	.595	80.7324	.598	80.8160	.605						
80.6541	.595	80.7325	.598	80.8161	.605						
80.6601	.596	80.7326	.598	80.8162	.605						
80.6602	.596	80.7410	.599	80.8163	.605						
80.6603	.596	80.7420	.599	80.8164	.605						
80.6604	.596	80.7431	.599	80.8191	.605						
80.6605	.596	80.7501	.600	80.8192	.605						
80.6606	.596	80.7503	.600	80.8201	.606						
80.6611	.596	80.7504	.600	80.8202	.606						
80.6612	.596	80.7511	.600	80.8211	.606						
80.6613	.596	80.7513	.600	80.8212	.606						
80.6614	.596	80.7514	.600	80.8213	.606						
80.6615	.596	80.7551	.600	80.8214	.606						
80.6616	.596	80.7552	.600	80.8221	.606						
80.6621	.596	80.7553	.600	80.8222	.606						
80.6622	.596	80.7601	.601	80.8223	.606						
80.6623	.596	80.7602	.601	80.8224	.606						
80.6624	.596	80.7603	.601								
80.6625	.596	80.7604	.601								
80.6626	.596	80.7605	.601								
80.6631	.596	80.7606	.601								
80.6632	.596	80.7611	.601								
80.6633	.596	80.7612	.601								
80.6634	.596	80.7613	.601								
80.6635	.596	80.7614	.601								
80.6636	.596	80.7615	.601								
80.6641	.596	80.7616	.601								
80.6642	.596	80.7621	.601								
80.6643	.596	80.7622	.601								
80.6644	.596	80.7623	.601								
80.6645	.596	80.7624	.601								
80.6646	.596	80.7625	.601								
80.6803	.597	80.7626	.601								
80.6805	.597	80.7801	.601								
80.6807	.597	80.7821	.601								
80.6810	.597	80.7901	.602								
80.6813	.597	80.7902	.602								
80.6815	.597	80.7903	.602								
80.6817	.597	80.7904	.602								
80.6820	.597	80.7905	.602								
80.6841	.597	80.7906	.602								
80.6842	.597	80.7911	.602								
80.6850	.597	80.7912	.602								
80.6851	.597	80.7913	.602								
80.7001	.598	80.7914	.602								
80.7002	.598	80.7915	.602								
80.7003	.598	80.7916	.602								
80.7004	.598	80.7950	.602								
80.7005	.598	80.7960	.602								
80.7006	.598	80.7962	.602								
80.7011	.598	80.7980	.602								
80.7012	.598	80.8000	.603								
80.7013	.598	80.8010	.603								
80.7014	.598	80.8050	.603								
80.7015	.598	80.8052	.603								
80.7016	.598	80.8054	.603								
80.7301	.598	80.8060	.604								
80.7302	.598	80.8062	.604								
80.7303	.598	80.8064	.604								
80.7304	.598	80.8100	.604								
80.7305	.598	80.8105	.604								
80.7306	.598	80.8110	.604								
80.7311	.598	80.8115	.604								

